



INSTRUMENTS

AirLink Alert Operator's Manual

Part Number: 71-0557

Revision: P8

Released: 1/29/26

**RKI Instruments, Inc.
www.rkiinstruments.com**

WARNING

Read and understand this instruction manual before operating detector. Improper use of the detector could result in bodily harm or death.

Periodic calibration and maintenance of the detector is essential for proper operation and correct readings. Please calibrate and maintain this detector regularly! Frequency of calibration depends upon the type of use you have and the sensor types. For most applications, typical calibration frequencies are between 3 and 6 months but can be more often or less often based on your usage.

Product Warranty

RKI Instruments, Inc. warrants gas alarm equipment sold by us to be free from defects in materials, workmanship, and performance for a period of one year from date of shipment from RKI Instruments, Inc. Any parts found defective within that period will be repaired or replaced, at our option, free of charge. This warranty does not apply to those items which by their nature are subject to deterioration or consumption in normal service, and which must be cleaned, repaired, or replaced on a routine basis. Examples of such items are:

- Absorbent cartridges
- Fuses
- Pump diaphragms and valves
- Batteries
- Filter elements

Warranty is voided by abuse including mechanical damage, alteration, rough handling, or repair procedures not in accordance with the operator's manual. This warranty indicates the full extent of our liability, and we are not responsible for removal or replacement costs, local repair costs, transportation costs, or contingent expenses incurred without our prior approval.

THIS WARRANTY IS EXPRESSLY IN LIEU OF ANY AND ALL OTHER WARRANTIES AND REPRESENTATIONS, EXPRESSED OR IMPLIED, AND ALL OTHER OBLIGATIONS OR LIABILITIES ON THE PART OF RKI INSTRUMENTS, INC. INCLUDING BUT NOT LIMITED TO, THE WARRANTY OF MERCHANTABILITY OR FITNESS FOR A PARTICULAR PURPOSE. IN NO EVENT SHALL RKI INSTRUMENTS, INC. BE LIABLE FOR INDIRECT, INCIDENTAL, OR CONSEQUENTIAL LOSS OR DAMAGE OF ANY KIND CONNECTED WITH THE USE OF ITS PRODUCTS OR FAILURE OF ITS PRODUCTS TO FUNCTION OR OPERATE PROPERLY.

This warranty covers instruments and parts sold to users by authorized distributors, dealers, and representatives as appointed by RKI Instruments, Inc.

We do not assume indemnification for any accident or damage caused by the operation of this gas monitor, and our warranty is limited to the replacement of parts or our complete goods.

Danger Statements

DANGER: The RKI Instruments Inc. AirLink Alert is an ambient air Hazardous gas sensor assembly and only monitors in the immediate vicinity of the sensor housing. A site survey is required in order to determine the best placement and quantity of sensor assemblies. Improper installation can lead to an undetectable gas leak which could result in personal injury or loss of life.

Table of Contents

Overview	6
Specifications	7
External Description	10
Internal Description	11
Exploded Drawing	12
Remote-Mounted Kit	13
Installation	13
Mounting the AirLink Alert	13
Remote-Mounted Kit Wiring	16
Connecting the Batteries.....	17
Closing the Enclosure.....	18
Start Up	19
Operation	21
Normal Operating Mode.....	21
Magnetic Buttons	22
Powering the Device.....	22
Faults.....	23
Accessing Menus	23
Product Settings and Configuration	24
Entering the Product Settings and Configuration Menu.....	24
Alarm Test.....	25
Network ID	26
System Information.....	26
Zero/Calibration Timer Information.....	27
Unit Information	27
Background.....	28

Calibration Method	29
Display Screen Contrast Setting	30
Return to Factory Default Settings	31
Reset Zero & Calibration Values	32
Operation Settings and Calibration.	33
Zeroing the Sensor (20.9% for O2)	33
Calibrating the Sensor (Manual Cal)	35
Calibrating the Sensor (Auto Cal)	37
Sensor Radio Address	40
Maintenance.	41
Troubleshooting	42
Replacing the Desiccant	42
Replacing the Batteries	42
Cleaning the 10.0 eV or 10.6 eV PID Lamp.	45
Replacing the PID Lamp.	49
Replacing the PID Electrode Stack.	52
Replacing the Sensor	56
Replacing the Fuse	58
Parts List	61

Overview

The RKI Instruments, Inc. AirLink Alert non-explosion-proof ambient air hazardous gas detector is designed to detect a wide range of toxic gases in potentially hazardous environments. The AirLink Alert features non-intrusive magnetic switches that allow for complete system configuration, regular calibration, and product maintenance to be performed in the field, without opening the enclosure and breaking the seal of the enclosure. Non-intrusive interface with the AirLink Alert is made possible by use of the magnetic tool included in the purchase of the device.

In this manual, the instructions reference the use of push-buttons, located on the front panel of the device. In certain environments, the activation of the non-intrusive magnetic switches, through the use of the magnetic tool, will replace the directive of the button-press actions. To apply the magnetic tool, hold the tool to the side of the device enclosure adjacent to the push-button that you wish to activate. When the magnetic switch is toggled, an on-screen indicator will appear on the display screen, signifying that a connection was made.

The AirLink Alert display screen will always show the current concentration of gas being detected by the sensor assembly.

This document is an operation manual containing diagrams and step-by-step instructions for the proper and safe installation, start-up, configuration, normal operation, and product maintenance of the AirLink Alert.

NOTE: This document should be read in its entirety before the initial operation of the product.

Specifications

Table 1 and Table 2 list detector and system specifications for the AirLink Alert.

Table 1: Detector Specifications

Target Gas	Detection Range	Increments	Alarm Points (1 / 2 / 3 / 4)*
Ammonia (NH ₃)	0-100 ppm	1 ppm	12 / 25 / 50 / 100 ppm
	0-1,000 ppm		35 / 300 / 300 / 1,000 ppm
Arsine (AsH ₃)	0-1.00 ppm	0.01 ppm	0.2 / 0.5 / 1.0 / 1.0 ppm
Carbon Dioxide (CO ₂)	0-5.0% volume	0.1% volume	0.5 / 3.0 / 5.0 / 5.0% volume
Carbon Monoxide (CO)	0-1,000 ppm	1 ppm	1,000 / 1,000 / 1,000 / 1,000 ppm
Chlorine (Cl ₂)	0-10.0 ppm	0.1 ppm	1 / 3 / 5 / 10 ppm
Chlorine Dioxide (ClO ₂)	0-1.00 ppm	0.01 ppm	0.1 / 0.3 / 0.3 / 1.0 ppm
Combustible Gas	0-100% LEL	1% LEL	10 / 20 / 50 / 100% LEL
Ethylene Oxide (EtO)	0-10.0 ppm	0.1 ppm	1 / 3 / 5 / 10 ppm
Formaldehyde (CH ₂ O)	0-10.00 ppm	0.01 ppm	0.5 / 2 / 5 / 10 ppm
Hydrogen (H ₂)	0-100% LEL	1% LEL	10 / 20 / 50 / 100% LEL
Hydrogen Chloride (HCl)	0-20 ppm	1 ppm	5 / 10 / 10 / 20 ppm
	0-100 ppm		5 / 10 / 30 / 100 ppm
Hydrogen Cyanide (HCN)	0-50 ppm		5 / 10 / 15 / 50 ppm
Hydrogen Fluoride (HF)	0-10.0 ppm	0.1 ppm	3 / 6 / 6 / 10 ppm
Hydrogen Sulfide (H ₂ S)	0-10.0 ppm	1 ppm	1 / 5 / 10 / 10 ppm
	0-25 ppm		5 / 10 / 10 / 25 ppm
	0-50 ppm		5 / 10 / 10 / 50 ppm
	0-100 ppm		10 / 50 / 75 / 100 ppm
	0-500 ppm		100 / 200 / 200 / 500 ppm
	0-2,000 ppm		100 / 200 / 200 / 2,000 ppm
Nitric Oxide (NO)	0-250 ppm		25 / 50 / 100 / 100 ppm
Nitrogen Dioxide (NO ₂)	0-20 ppm		5 / 10 / 10 / 20 ppm
Oxygen (O ₂)	0-25.0% volume	0.1% volume	19.5% dec. / 23.5% inc. / 17.0% dec. / 25.0% inc.
Ozone (O ₃)	0-5.0 ppm	0.1 ppm	1 / 3 / 5 / 5 ppm
	0-100 ppm	1 ppm	10 / 15 / 15 / 100 ppm
Phosphine (PH ₃)	0-5.0 ppm	0.1 ppm	0.3 / 1.0 / 1.0 / 5.0 ppm
Sulfur Dioxide (SO ₂)	0-20 ppm	1 ppm	2 / 5 / 5 / 20 ppm

Table 1: Detector Specifications

Target Gas	Detection Range	Increments	Alarm Points (1 / 2 / 3 / 4)*
Volatile organic compounds (VOCs), benzene calibration standard	<u>10.0 eV Lamp</u>		
	0 - 10 ppm	0.01 ppm	1 / 1.5 / 1.5 / 10 ppm
	0 - 20 ppm		2 / 3 / 3 / 20 ppm
	0 - 50 ppm		5 / 7.5 / 7.5 / 50 ppm
	0-100 ppm	1 ppm	10 / 15 / 15 / 100 ppm
Volatile organic compounds (VOCs), isobutylene calibration standard	<u>Low Range 10.6 eV Lamp</u>		
	0 - 10.00 ppm	0.01 ppm	1 / 1.5 / 1.5 / 10 ppm
	0 - 20.00 ppm		2 / 3 / 3 / 20 ppm
	0 - 50.00 ppm		5 / 7.5 / 7.5 / 50 ppm
	<u>High Range 10.6 eV Lamp</u>		
	0 - 100 ppm	1 ppm	10 / 15 / 15 / 100 ppm
	0 - 200 ppm		20 / 30 / 30 / 200 ppm
	0 - 500 ppm		50 / 75 / 75 / 500 ppm
	0 - 1,000 ppm		100 / 150 / 150 / 1,000 ppm
	0 - 2,000 ppm		200 / 300 / 300 / 2,000 ppm
	<u>11.7 eV Lamp</u>		
0 - 100 ppm	0.01 ppm	10 / 15 / 15 / 100 ppm	
* Alarms are only programmable at a controller and do not affect operation of the AirLink Alert.			

Table 2: System Specifications

Sampling Method	Diffusion
Zero Suppression	<ul style="list-style-type: none"> • O₂ channels: No zero suppression • PID channels: 0.1% of full scale • All other channels: 1% of full scale
Battery Type	2 lithium-thionyl (Li-SOCl ₂) batteries, 3.6 VDC 19Ah each, 38 Ah total
Battery Life	<ul style="list-style-type: none"> • LEL versions: 10 - 12 months • PID versions: At least 14 days • Electrochemical versions: Up to 2 years <p><i>NOTE: When the battery indicator is blank, approximately 2 weeks of battery life remain.</i></p>
Current Draw	300 mA max
Operating Temperature Range	-40°C to +70°C (-40°F to +158°F)
Humidity Range	0 - 98% relative humidity, non-condensing

Table 2: System Specifications

Signal Output	<ul style="list-style-type: none">• 900 MHz - 52 networks, 255 sensors per network OR <ul style="list-style-type: none">• 2.4 GHz - 78 networks, 255 sensors per network
Max Cable Length for Remote-Mounted Antenna	100 feet
Enclosure Material	Polycarbonate enclosure with clear lid
Sensor Housing Material	Black polypropylene plastic with SS mesh screen
Max Cable Length for Remote-Mounted Sensor Kit	<ul style="list-style-type: none">• Electrochemical (EC): 250 feet• Infrared (IR): 40 feet• PID: 35 feet
Dimensions	5.16" D x 5.12" W x 7.09" H (maximum)
Weight	3.25 lbs.

WARNING: When using the AirLink Alert, you must follow the instructions and warnings in this manual to assure proper and safe operation of the AirLink Alert and to minimize the risk of personal injury. Be sure to maintain and periodically calibrate the AirLink Alert as described in this manual.

External Description

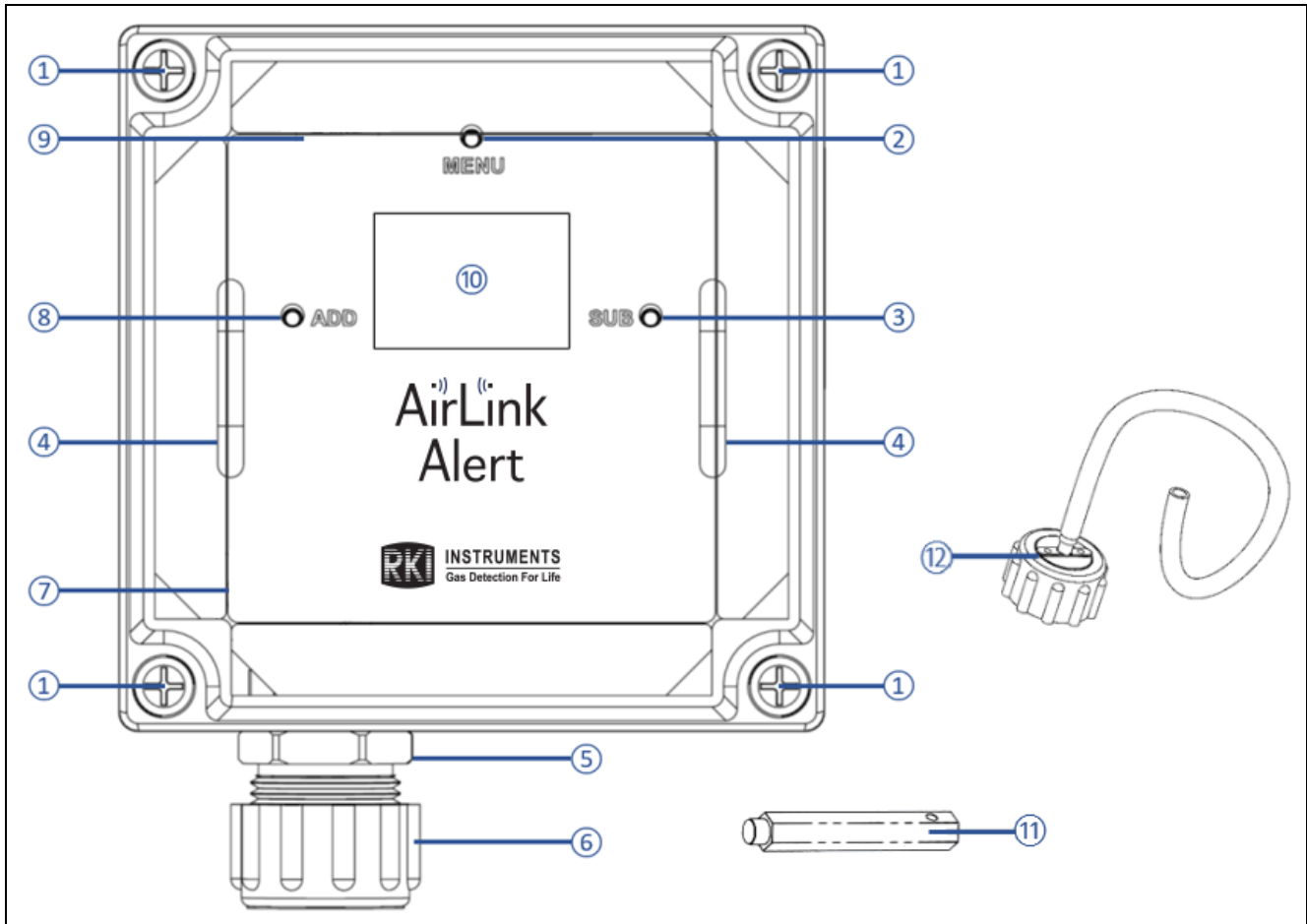

Figure 1: External Component Location

1	Enclosure screw
2	MENU button
3	SUB button
4	Front panel handle
5	Sensor housing base
6	Sensor housing cap

7	Gas type label
8	ADD button
9	Radio type label
10	LCD
11	Magnetic tool
12	Calibration cup

Internal Description

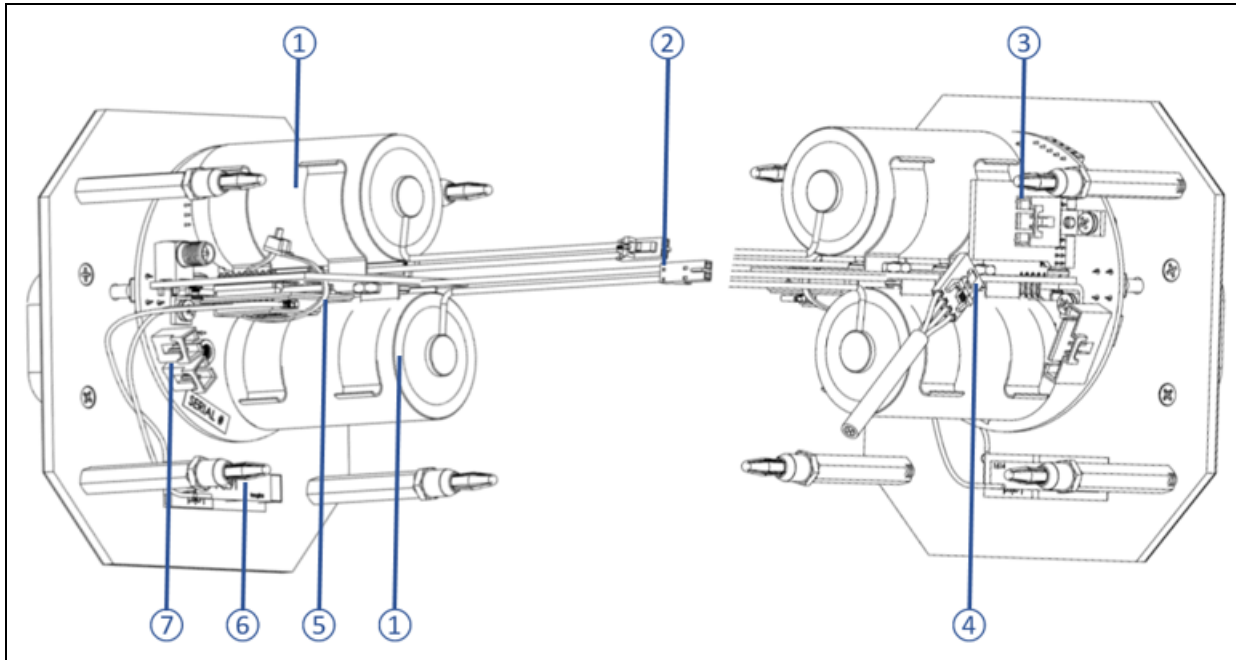

Figure 2: Internal Component Location

1	Batteries
2	Battery plugs
3	Sensor housing connector
4	Sensor housing plug

5	Radio module
6	Internal flexible antenna
7	Battery plug connectors

Exploded Drawing

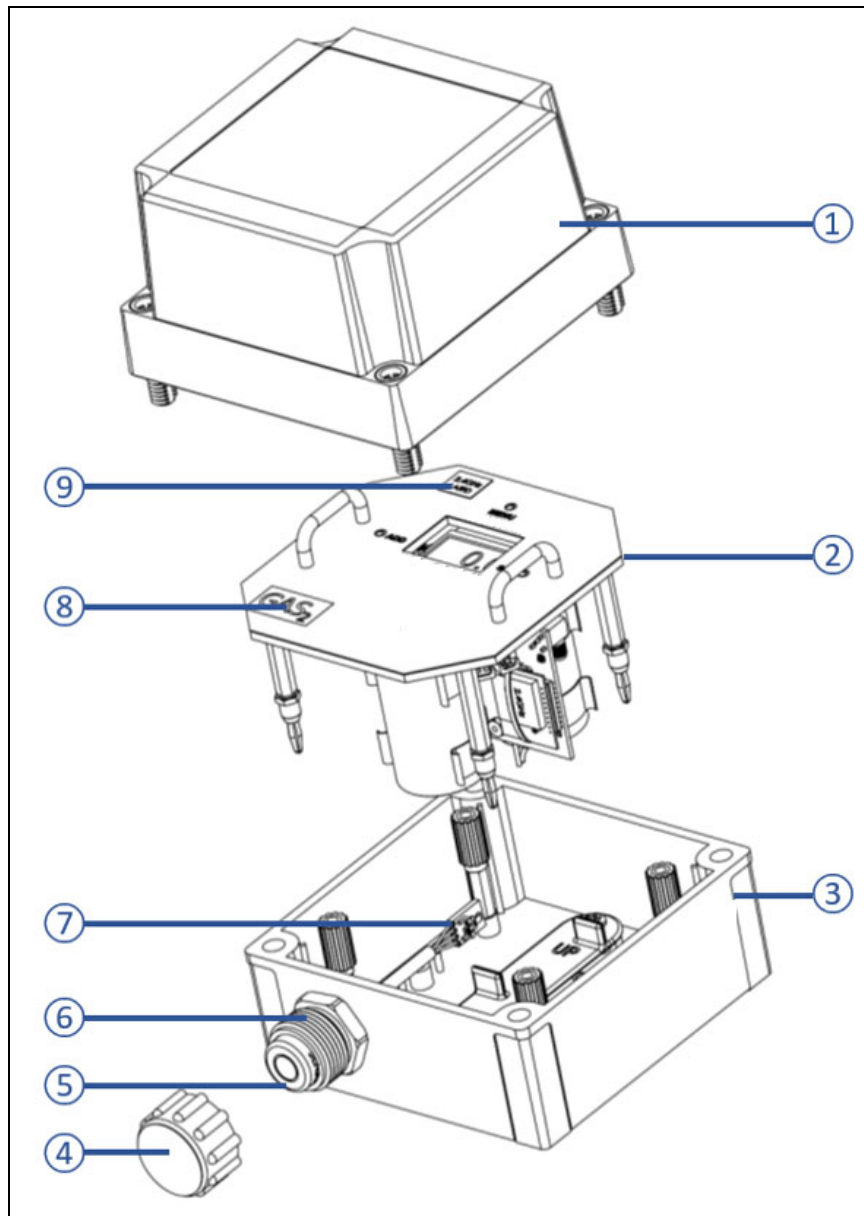

Figure 3: Exploded Diagram

1	Enclosure lid
2	Internal system
3	Enclosure base
4	Sensor housing cap
5	Sensor element

6	Sensor housing base
7	Sensor housing plug
8	Gas type label
9	Radio type label

Remote-Mounted Kit

A remote-mounted sensor kit can be ordered if the sensor needs to be somewhere that is not conveniently accessible for viewing the display screen.

The kit includes a second junction box on a cable with a cable bushing/cable gland. The cable can be ordered in 1-foot increments with maximum cable lengths listed below.

Sensor Type	Max Cable Length
Electrochemical (EC)	250 feet
Infrared (IR)	40 feet
PID	35 feet

Installation

This section describes procedures to mount the AirLink Alert in the monitoring environment and wire the AirLink Alert.

NOTE: Radio connections between AirLink sensors and monitors must either all be routed through a repeater or all go straight to the monitor.

Mounting the AirLink Alert

1. Consider the following when you select the mounting site.
 - The unit should be placed greater than 6.5 feet/2 meters away from a monitor in order to ensure reliable communications.
 - Select a site where the AirLink Alert is not likely to be bumped or disturbed. Make sure there is sufficient room to perform start-up, maintenance, and calibration procedures.
 - Select a site that is representative of the monitoring environment and where the target gas is likely to accumulate or where it is most likely to leak. The AirLink Alert should not be installed near an entrance, air intake, or exhaust point.
 - The sensor must point down.
 - Avoid installing the AirLink Alert in a location where airborne particles could cover or coat the sensor.

NOTE: These guidelines are **ONLY** intended as a general directive for the placement of the AirLink Alert. This information should **NOT** serve as a complete list when considering all potential parameters for the proper location of the unit. It is **STRONGLY** advised that a third party Certified Industrial Hygienist, or other Certified Safety Professional, conduct a site survey and annotate the location and quantity of detection devices that should be installed for **EVERY** installation of **EVERY** site.

2. Select a mounting location and installation hardware. Mounting to a concrete or steel structure is recommended to minimize vibration and moisture. Use a maximum #8 screw, flat washers, Grade 5 material, and corrosion protection like paint, galvanization, or zinc plating.

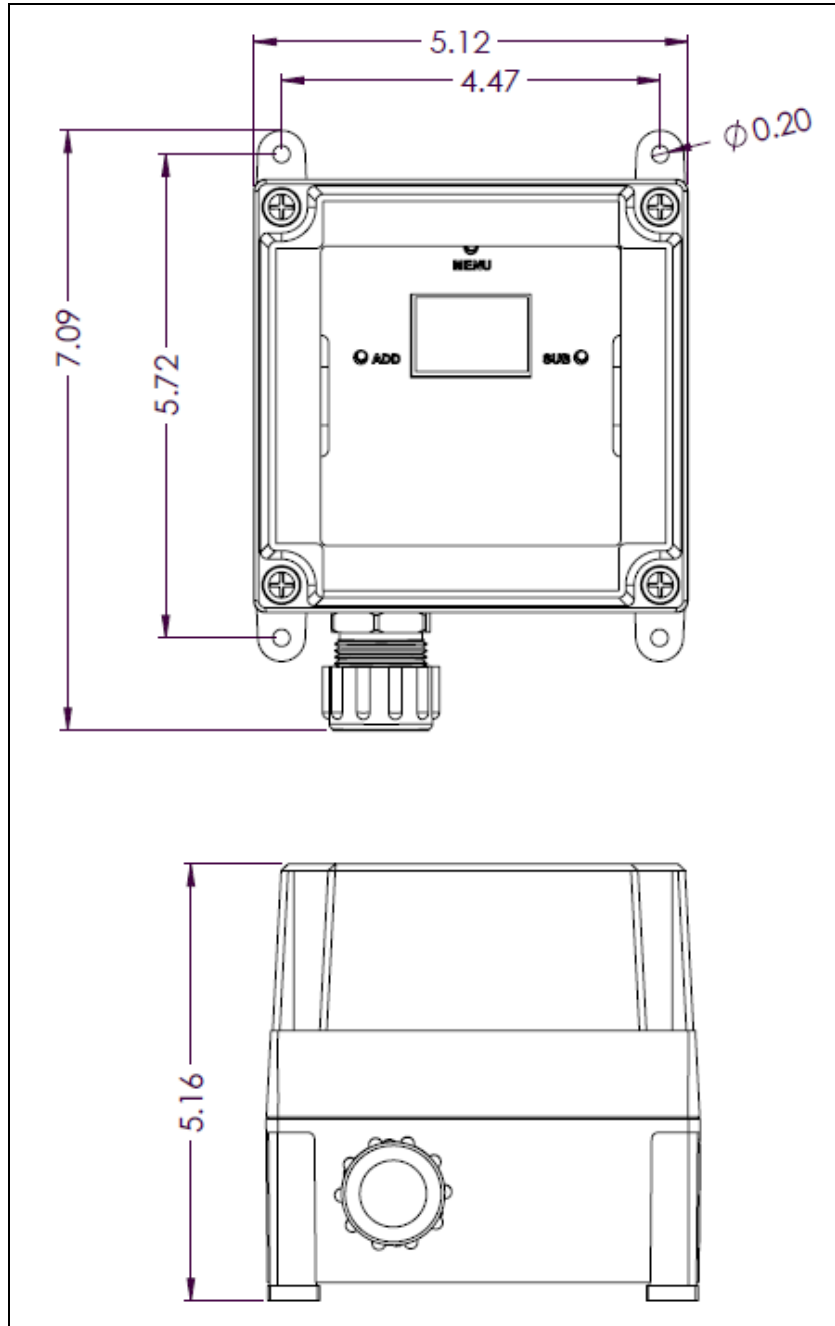

Figure 4: Dimensions

3. For a remote-mounted kit, install the detector junction box at the monitoring location using techniques appropriate for the local electrical code.

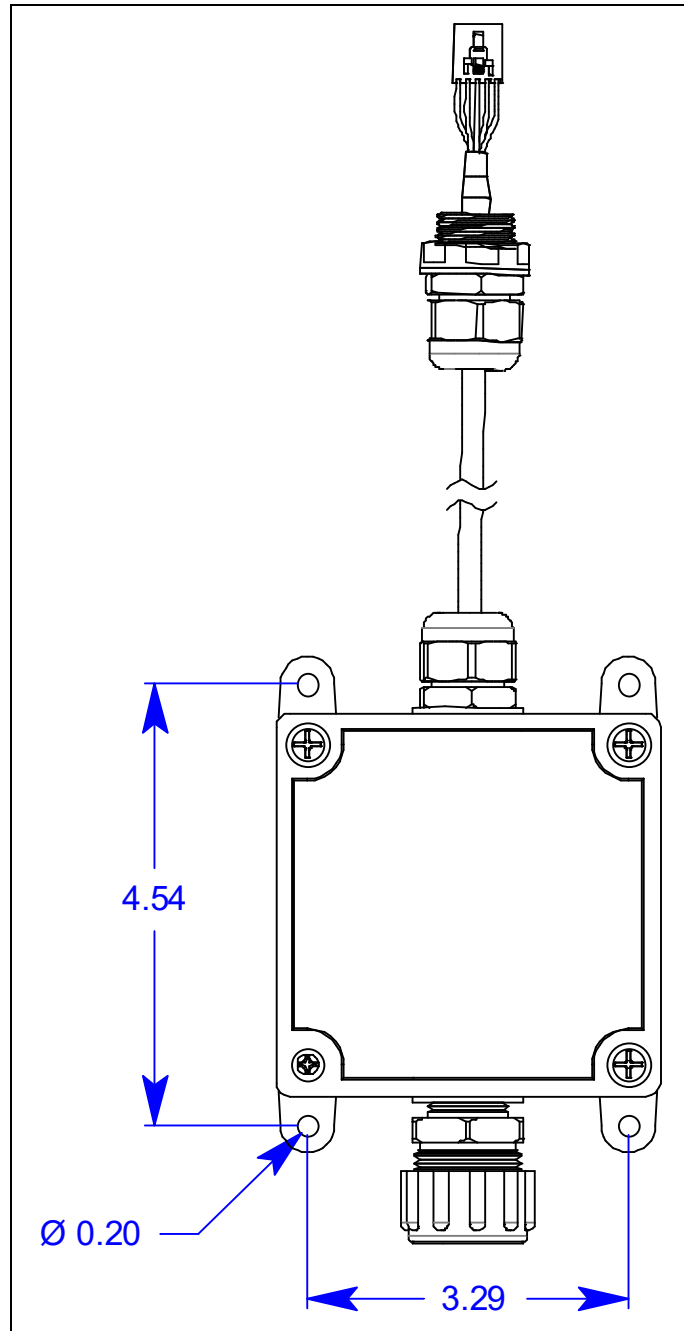

Figure 5: Remote-Mounted Kit's Detector Junction Box Dimensions

Remote-Mounted Kit Wiring

The remote-mounted kit generally comes prewired but if it becomes disconnected, follow these steps to reconnect it.

CAUTION: *The internal components can be static sensitive. Use caution when opening the enclosure and handling internal components.*

CAUTION: *Make sure the power source is off before beginning the wiring procedure.*

CAUTION: ***DO NOT** use any metal objects or tools to remove the terminal board from the internal system.*

1. Unscrew the captive screws from each junction box. Remove the enclosure lid and set it aside.
2. Grab the handles on the front panel and pull the internal system out of the enclosure. It can rest on the edge of the enclosure.
3. One end of the cable has a connector and the other has ferruled wires.
4. Feed the connector end of the cable through a conduit hub at the amplifier junction box.
5. Plug the connector into the sensor connector socket at the amplifier junction box.
6. Feed the ferruled-wire end of the cable through a conduit hub at the detector junction box.
7. Connect the ferruled wires to the color-coded terminals in the detector junction box.
8. Place the internal system back into the enclosure, matching each mounting post to its corresponding eyelet anchored within the base of the enclosure.
9. Using the front panel handles, gently push to seat the internal system into the mounting posts.
10. Reinstall the enclosure lid by tightly screwing the captive screws into the enclosure base.

Connecting the Batteries

The AirLink Alert is powered by dual 3.6V/19AH lithium-thionyl batteries. The batteries are shipped installed but with the wiring disconnected. The batteries should be replaced in pairs. Do not mix old and new batteries.

CAUTION: *The internal components can be static sensitive. Use caution when opening the enclosure and handling internal components.*

CAUTION: ***DO NOT** use any metal objects or tools to remove the terminal board from the internal system.*

CAUTION: *Use only RKI-supplied batteries.*

1. Unscrew the captive screws from the enclosure base. Remove the enclosure lid and set it aside.
2. Grab the front panel handles and gently lift the internal system out of the enclosure. It can rest on the edge of the enclosure.

NOTE: Disconnecting the sensor connector plug from the sensor housing connector and the antenna fitting will allow for the complete removal of the internal system from the device enclosure. Disconnecting the internal system may provide ease in accessing the control board terminals for wiring. Reconnect the sensor connector plug before reinstalling the internal system.

3. Insert the bottom battery cable's 2-pin connector plug into the bottom 2-pin connector socket on the board.
4. Insert the top battery cable's 2-pin connector plug into the top 2-pin connector socket on the board.

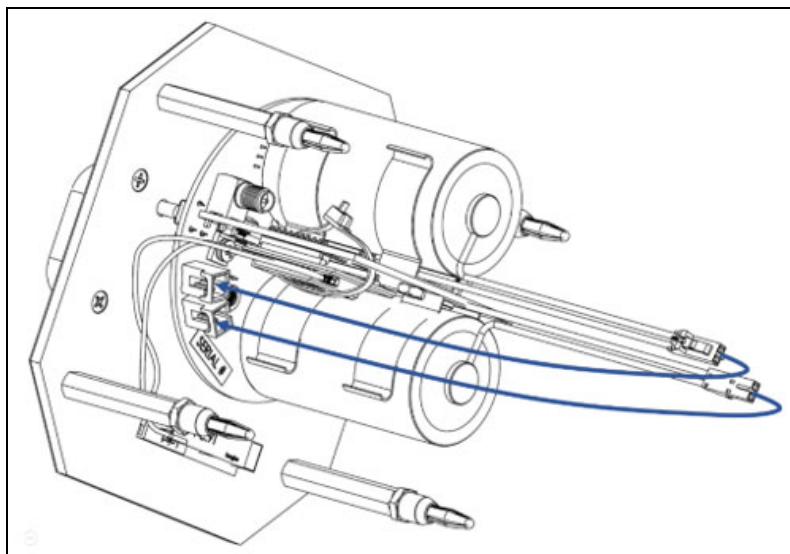

Figure 6: Battery Connection

Closing the Enclosure

1. Place the internal system back into the enclosure, matching each mounting post to its corresponding eyelet anchored within the base of the enclosure.
2. Using the front panel handles, gently push to seat the internal system into the mounting posts.
3. Reinstall the enclosure lid by tightly screwing the captive screws into the enclosure base.

Start Up

This section describes procedures to start up the AirLink Alert and place the AirLink Alert into normal operation.

1. Complete the installation procedures described earlier in this manual.
2. Verify that the power wiring is correct and secure.
3. Turn on the power source.
4. Verify that the controller is on and operating properly. Refer to the controller operator's manual.
5. The AirLink Alert automatically powers on and enters a 1-minute startup period (3.5 minutes for LEL versions).

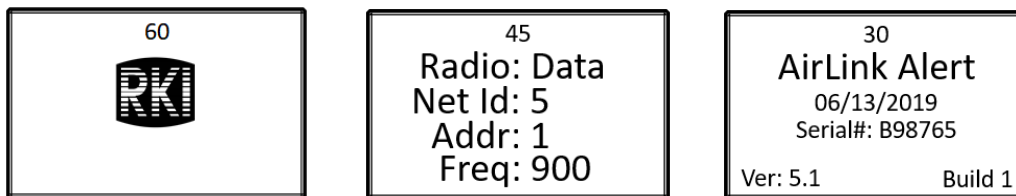

6. At the end of the startup, the AirLink Alert is in Normal Operating Mode.

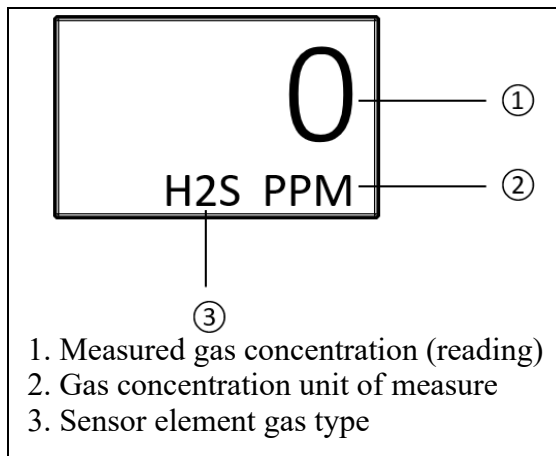

7. Allow the detector to warmup for the appropriate amount of time as shown below, depending on the sensor type.

Detection Gas	Warmup Time After an <u>Extended</u> Time Off Power	Warmup Time After a <u>Short</u> Time Off Power
Ammonia (NH ₃)	12 hours	4 hours
Arsine (AsH ₃)	2 hours	10 minutes
Carbon Dioxide (CO ₂)	10 minutes	

Detection Gas	Warmup Time After an <u>Extended</u> Time Off Power	Warmup Time After a <u>Short</u> Time Off Power
Carbon Monoxide (CO)	2 hours	10 minutes
Chlorine (Cl ₂)		
Chlorine Dioxide (ClO ₂)		
Combustible Gas	10 minutes	
Ethylene Oxide (EtO)	48 hours	
Formaldehyde (CH ₂ O)	10 minutes	
Hydrogen (H ₂)	2 hours	
Hydrogen Chloride (HCl)	12 hours	
Hydrogen Cyanide (HCN)		
Hydrogen Fluoride (HF)	2 hours	
Hydrogen Sulfide (H ₂ S)		
Nitric Oxide (NO)	72 hours	
Nitrogen Dioxide (NO ₂)	2 hours	
Oxygen (O ₂)		
Ozone (O ₃)		
Phosphine (PH ₃)		
Sulfur Dioxide (SO ₂)		
VOCs	10 minutes	

8. The AirLink Alert is factory-calibrated before shipping from RKI. If a full calibration is desired at startup, see page 33.

Operation

WARNING: Do not remove the sensor housing cap or enclosure lid while the circuits are energized unless the area is determined to be non-hazardous. Keep the sensor housing cap and enclosure lid tightly closed during operation.

Normal Operating Mode

While in Normal Operating Mode, the AirLink Alert continuously samples the air and updates the measured concentration of the target gas on the display screen. The display, when in Normal Operating Mode, appears as shown below.

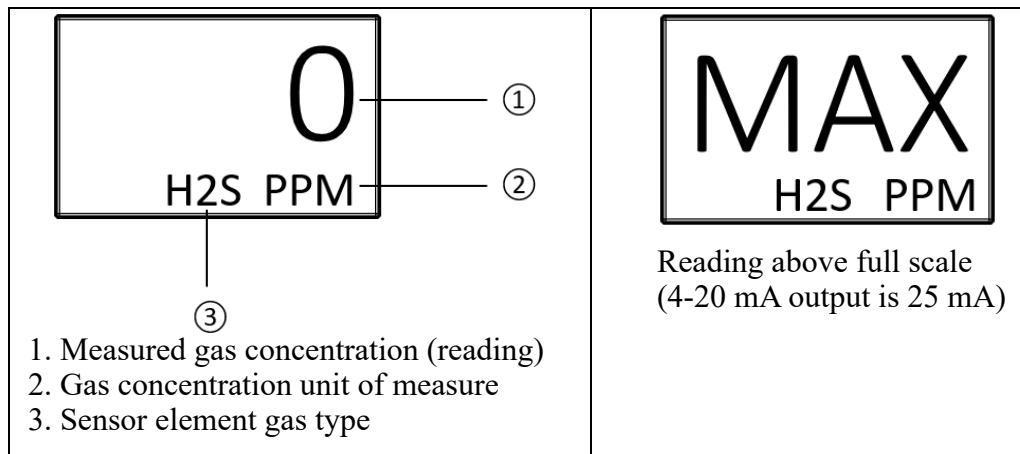

The gas reading is sent back to the controller in 1-minute intervals when the reading is below the background setting (page 28). When the reading surpasses the background setting, the reading is sent back to the controller in 5-second intervals.

NOTE: The user interface will be slow to respond until the AirLink Alert establishes a connection with a controller.

Magnetic Buttons

Use the provided magnet to actuate the AirLink Alert's buttons without having to remove the junction box's lid. Touch the magnet to the outer edge of the junction box lid near the button you want to actuate. Tapping the junction box is the same as pressing and releasing the button. Holding the magnet against the junction box is the same as pressing and holding the button.

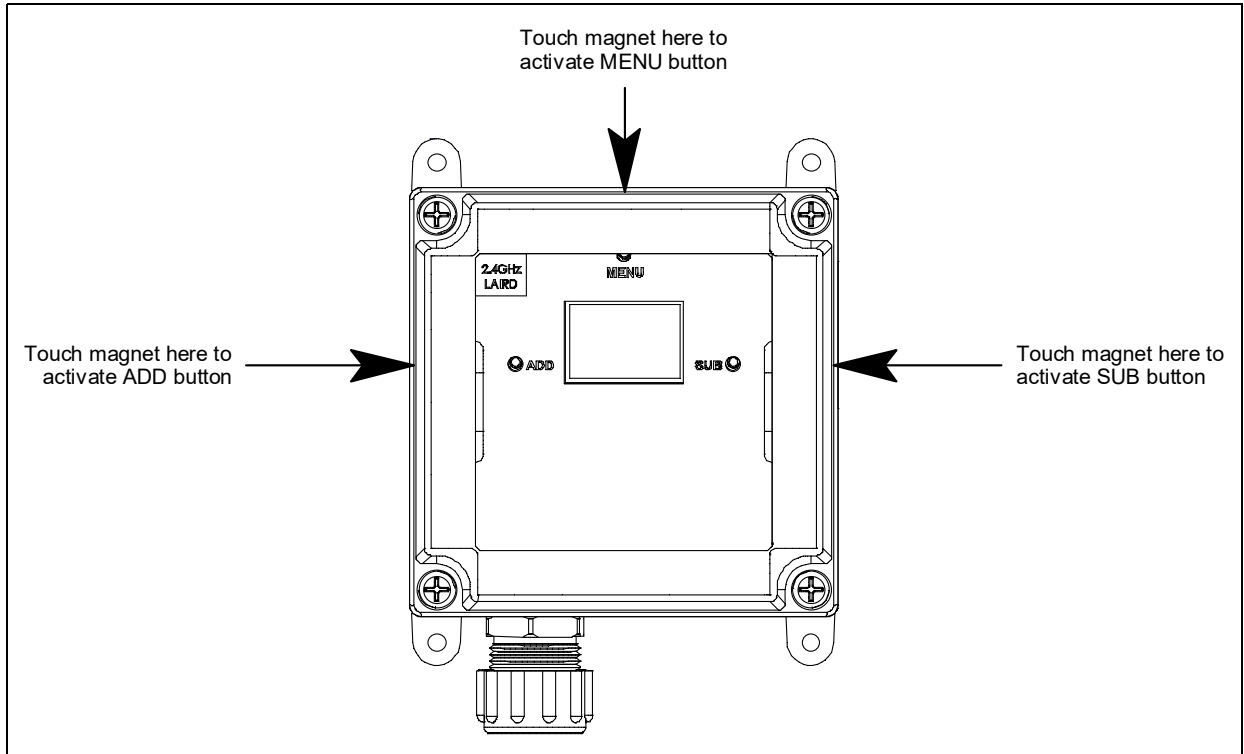

Powering the Device

When the AirLink Alert's batteries are first plugged in, the unit does not automatically power on. The directions below describe how to power on and power off the AirLink Alert once power has been applied.

Powering On

Powering on the device begins the operation of the unit, automatically initiating the system start-up cycle and 1-minute warmup period (3.5 minutes for LEL versions). The AirLink Alert will be in Normal Operating Mode at the completion of the system start-up.

To turn the AirLink Alert on, press the ADD button once.

Powering Off

Powering off the device stops the operation of the unit. The Product Settings and Configuration, as well as the operation settings, including the zero and calibration of the sensor, will be unaffected.

1. Press and hold the SUB button for approximately 6 seconds, until “OFF” shows on the display screen.

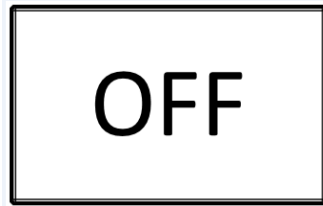

2. The display screen will continue to show “OFF” for the duration of time that the unit is powered off, as long as uninterrupted power is supplied to the unit.

Faults

In the event of a device failure, the unit will alternate between the normal operating screen and a fault screen on the display, in 5 second intervals, until the fault has been cleared, or is corrected. The fault code, located in the bottom-left corner of the display, appears on both screens. The unit continuously registers that the system is in fault. When the fault is corrected, the unit will return to normal operating mode.

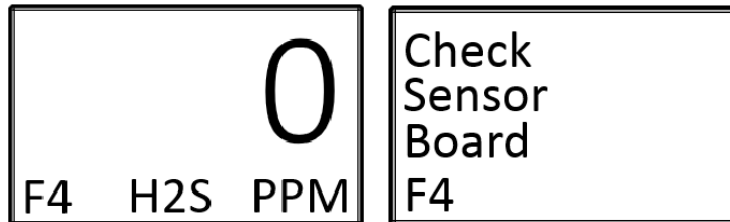

For a list of the fault codes and warning symbols of the AirLink Alert, and their associated meaning, see page 42.

Accessing Menus

Both system menus are accessible from Normal Operating Mode. To access the Product Settings and Configuration menu, **press and hold** the **MENU** button, for approximately 6 seconds, until the menu is activated and open on the display screen. To access the Operation Settings menu from Normal Operating Mode, press and release the **MENU** button once and the menu will open and show on the display.

NOTE: After 10 minutes of no interaction with the device, the unit will automatically return to Normal Operating Mode.

Product Settings and Configuration

The Product Settings and Configuration menu allows the end-user to tailor the device settings to meet their required specifications and/or site conditions.

The AirLink Alert continues monitoring for gas while in the Product Settings and Configuration menu.

The Product Settings and Configuration menu consists of the following screens:

- Alarm Test (see page 25)
- Network ID (see page 26)
- System Information (see page 26)
- Zero/Calibration Timers (see page 27)
- Unit Info (see page 27)
- Background Setting (see page 28)
- Calibration Method (see page 29)
- Display Screen Contrast Setting (see page 30)
- Return to Factory Default Settings (see page 31)
- Reset Zero and Calibration Values Only (see page 32)

Entering the Product Settings and Configuration Menu

While the device is in normal operating mode, **press and hold** the **MENU** button, for approximately 6 seconds, until the Product Settings and Configuration menu is activated and open on the display screen.

NOTE: After 10 minutes of no interaction with the device, the unit will automatically return to normal operating mode.

NOTE: The alarms will NOT activate, even in the presence of gas, until you have been out of the Product Settings and Configuration menu for 1 minute.

Alarm Test

The alarm test simulates a gas level reading. The alarm test is used to ensure the proper functionality of the relay settings on the controller. The test can also be used to simulate emergency/safety drills onsite.

NOTE: Triggering AirLink Alert relays will also simulate Alarm 1 and Alarm 2 relays at the controller. Controllers cannot distinguish between real and simulated data received. When the controller relays are triggered, alarm devices will perform as intended, initiating emergency procedures as if a harmful or toxic gas was actually present. To prevent this from occurring, set the controller to calibration mode before performing the alarm test. Calibration mode allows data transmission without relay activation.

It is recommended that an alarm test be conducted EVERY 30 days, alongside the maintenance and calibration of the detector.

Performing the Alarm Test

The alarm test gas level reading can be increased or decreased in increments of 5% of the sensor scale, up to 100% of the sensor scale.

1. Enter the Product Settings and Configuration menu by pressing and holding the MENU button for 6 seconds. The alarm test screen appears.

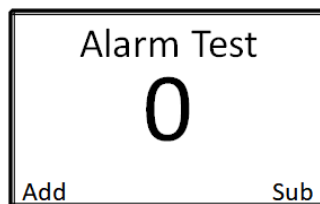

2. Press the ADD button until the alarm levels are reached.
3. Once the test is complete, press the SUB button to return the alarm test reading back to zero and to deactivate the controller alarm(s).
4. Use the MENU button to scroll through the rest of the Product Settings and Configuration menu and return to Normal Operating Mode.

Network ID

The Network ID is used to synchronize the communication between a wireless controller and the AirLink Alert:

- There are 52 networks available with the GEN II 900 MHz radio.
- There are 78 networks available with the GEN II 2.4 GHz radio.

The controller and AirLink Alert must have the same Network ID in order to communicate.

NOTE: Radio connections between AirLink sensors and monitors must either all be routed through a repeater or all go straight to the monitor.

1. If necessary, enter the Product Settings and Configuration menu by pressing and holding the MENU button for 6 seconds.
2. Press and release the MENU button until the Network ID screen appears.

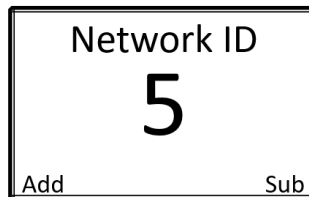

3. Press the ADD or SUB button until the Network ID matches the value being used on the Primary Monitor.
4. Use the MENU button to scroll through the rest of the Product Settings and Configuration menu and return to Normal Operating Mode.

System Information

The system information screen allows the end-user to view the following information:

- The connection status to the primary controller
- The scale of the sensor element.
- The supply voltage of the sensor unit.
- The voltage value (in volts) that the sensor was reading when zeroed.
- The current voltage value (in volts) that the sensor element is reading.

This screen is for informational purposes only.

1. If necessary, enter the Product Settings and Configuration menu by pressing and holding the MENU button for 6 seconds.
2. Press and release the MENU button until the System Information screen appears.

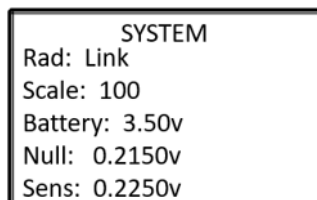

3. Review the information displayed.
4. Use the MENU button to scroll through the rest of the Product Settings and Configuration menu and return to Normal Operating Mode.

Zero/Calibration Timer Information

The zero/calibration time information screen allows the end-user to view the following information:

- The days since the sensor assembly was last zeroed.
- The days since the sensor assembly was last calibrated.
- The calibration number of the sensor, used for diagnostic purposes.

This screen is for informational purposes only.

NOTE: The Cal field automatically updates after an Auto Cal. When performing a Manual Cal, the gas reading must be adjusted by at least one button press to get the Cal field to update.

1. If necessary, enter the Product Settings and Configuration menu by pressing and holding the MENU button for 6 seconds.
2. Press and release the MENU button until the Zero/Calibration Timer Information screen appears.

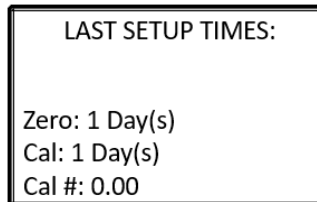

3. Review the information displayed.
4. Use the MENU button to scroll through the rest of the Product Settings and Configuration menu and return to Normal Operating Mode.

Unit Information

The unit information screen allows the end-user to view the following information:

- The number of missed radio transmissions to the controller.
- The date of manufacture of the sensor assembly.
- The serial number of the sensor assembly.

This screen is for informational purposes only.

1. If necessary, enter the Product Settings and Configuration menu by pressing and holding the MENU button for 6 seconds.

- Press and release the MENU button until the Unit Information screen appears.



- Review the information displayed.
- Use the MENU button to scroll through the rest of the Product Settings and Configuration menu and return to Normal Operating Mode.

Background

The background setting is the gas reading at which the radio transmission changes from once every minute to once every five seconds. The background setting is adjustable so that a consistent level of gas presence does not increase the radio transmission rate.

Oxygen sensor assemblies have 2 setpoints: L (for readings below 20.9%) and H (for readings above 20.9%).

	Non-O₂ Sensor Assemblies	O₂ Sensor Assemblies
Default	4% of full scale	L: 19.0% H: 22.0%
Minimum	1% of full scale	11.0%
Maximum	10% of full scale	24.0%

- If necessary, enter the Product Settings and Configuration menu by pressing and holding the MENU button for 6 seconds.
- Press and release the MENU button until the Background (BackgroundL for O₂ versions) screen appears.

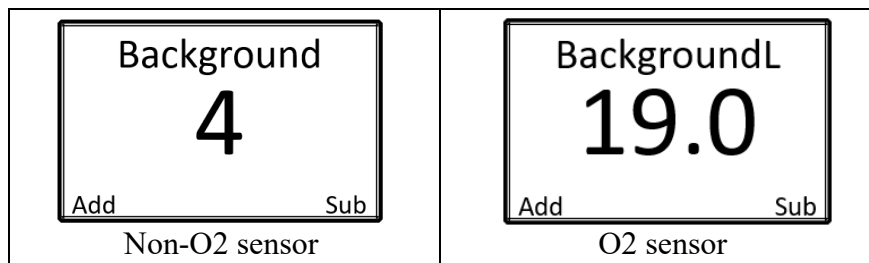

- Press the ADD or SUB button until the Background (BackgroundL for O₂ versions) is set to the desired level.
- For non-O₂ sensor assemblies, continue to Step 6.

5. For O₂ sensor assemblies:
 - a. Use the MENU button to scroll to the BackgroundH screen.



- b. Press the ADD or SUB button until the BackgroundH is set the desired level.
6. Use the MENU button to scroll through the rest of the Product Settings and Configuration menu and return to Normal Operating Mode.

Calibration Method

NOTE: LEL and CO₂ - This screen does not appear in LEL or CO₂ versions of the AirLink Alert because those sensors can only be calibrated using Auto Cal.

HCl - It is recommended that the HCl version only be calibrated using Auto Cal, but Manual Cal can be used if desired.

AsH₃ and HF - It is recommended that AsH₃ and HF versions only be calibrated using Manual Cal.

The calibration method selection allows you to choose how you calibrate the sensor element.

Manual Calibration (factory setting): Use the ADD and SUB buttons during calibration to match the reading shown on the screen to the value of the gas being applied.

Auto Calibration: Sets the reading, after a predetermined amount of time, during calibration to the value entered during the auto calibration setup process.

1. If necessary, enter the Product Settings and Configuration menu by pressing and holding the MENU button for 6 seconds.
2. Press and release the MENU button until the Cal Method screen appears.

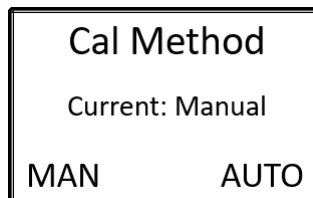

3. Use the ADD button to select manual calibration and the SUB button to select auto calibration.
 4. Use the MENU button to scroll through the rest of the Product Settings and Configuration menu and return to Normal Operating Mode.

Display Screen Contrast Setting

The display screen contrast is the difference in luminance or color that makes the displayed images distinguishable. Due to varying external elements, such as extreme sunlight, the brightness of the display screen may need to be adjusted for optimum viewing.

The factory default setting on the AirLink Alert for the display screen contrast is 53, approximately 83% of the contrast scale. The contrast setting ranges from 1 to 64.

NOTE: Setting the contrast too low will cause the display image to become faint or indistinguishable, especially when the unit is located in areas with full-sun. The resulting field of view could be misinterpreted as an error within the device. Be sure to verify that the selected contrast is within an appropriate range of viewing.

1. If necessary, enter the Product Settings and Configuration menu by pressing and holding the MENU button for 6 seconds.
2. Press and release the MENU button until the Contrast screen appears.

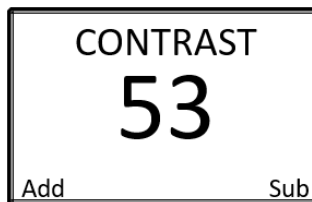

3. Use the ADD and SUB buttons to brighten and dim the contrast, respectively.
4. Use the MENU button to scroll through the rest of the Product Settings and Configuration menu and return to Normal Operating Mode.

Return to Factory Default Settings

Returning the AirLink Alert to its factory default settings will reset all customization of the device, including the zero and calibration settings of the sensor element. A factory default does not change the gas type.

Table 3: AirLink Alert Product and Configuration Factory Default Settings

Configuration	Setting
Network I.D.	5
Zero/Cal Timer	*Cleared*
Sensor Background Setting	4
Sensor Calibration Method (non-LEL versions only)	Manual
Sensor Zero	*Cleared*
Sensor Cal	*Cleared*
Sensor Radio Address	1

1. If necessary, enter the Product Settings and Configuration menu by pressing and holding the MENU button for 6 seconds.
2. Press and release the MENU button until the Return to Factory Default screen appears.

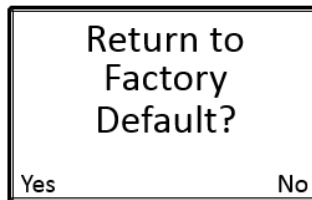

3. Press the ADD button to return the device to its factory default settings and to advance to the return to factory default settings confirmation screen. If you do not wish to return the device to its factory default settings, press the SUB or MENU button to continue to the Reset Zero & Cal Only screen.
4. If “Yes” is selected to return the device to its factory default settings:

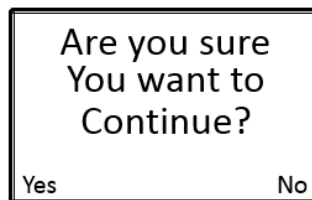

5. Press the ADD button to select “Yes” to confirm that you want to reset the device to its factory default settings and to return the device to normal operating mode. If you do not wish to continue to return the device to its factory default settings, press the SUB button to select “No” to continue to the Reset Zero & Cal Only screen.

6. Use the MENU button to scroll through the rest of the Product Settings and Configuration menu and return to Normal Operating Mode.

NOTE: If the AirLink Alert is reset to the factory default settings, ALL configuration steps MUST be repeated and the device MUST then be zeroed and calibrated for proper operation of the device.

Reset Zero & Calibration Values

Resetting the zero and calibration settings of the sensor element will allow the currently stored zero and calibration values to be reset without having to reconfigure all of the other operational settings like with the Return to Factory Defaults option.

1. If necessary, enter the Product Settings and Configuration menu by pressing and holding the MENU button for 6 seconds.
2. Press and release the MENU button until the Reset Zero & Calibration Values screen appears.

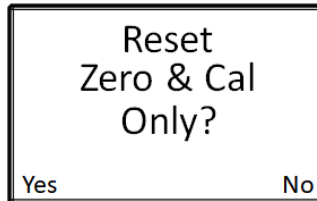

3. Press the ADD button to select “Yes” to reset the Zero and Calibration values and to advance to the Reset Zero & Cal Only confirmation screen. If you do not wish to reset the zero and calibration values, press the SUB button to select “No” to leave the Product Settings and Configuration menu and to return the device to normal operating mode.
4. If “Yes” is selected to reset the zero and calibration values:

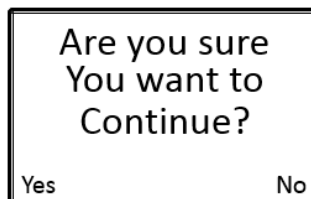

5. Press the ADD button to select “Yes” to confirm that you want to reset the Zero and Calibration values and to return the device to normal operating mode. If you do not wish to continue to reset the Zero and Calibration values, press the SUB button to select “No” to leave the Product Settings and Configuration menu and to return the device to normal operating mode.
6. Use the MENU button to return to Normal Operating Mode.

NOTE: If the AirLink Alert’s stored Zero and Calibration values are reset, the device MUST be zeroed and calibrated for proper and safe operation of the device.

Operation Settings and Calibration

The Operation Settings menu allows you to:

- perform a zero adjust
- perform a span adjust
- change sensor radio address

NOTE: After 10 minutes of no interaction with the device, the unit will automatically return to normal operating mode.

NOTE: The alarms will NOT activate, even in the presence of gas, until you have been out of the Operation Settings menu for 1 minute.

The AirLink Alert continues monitoring for gas while in the Operation Settings menu.

Zeroing the Sensor (20.9% for O₂)

The first step of calibration is zeroing (20.9% for O₂). The zeroing (20.9% for O₂) process **MUST** be performed in known clean air, with no contaminants or hazardous gasses present. If air quality cannot be guaranteed, a cylinder of zero air will be required to properly zero the sensor.

Materials

- 0.5 LPM fixed flow regulator with knob
- calibration cup
- calibration tubing
- zero air cylinder (if not in a fresh air environment)
- 100% N₂ cylinder (if zeroing a CO₂ sensor)

NOTE: Since there is a background of CO₂ in air, it is necessary to use a CO₂-free cylinder when zeroing a CO₂ sensor.

Procedure

1. While the product is in normal operating mode, press the MENU button to activate the Operation Settings menu.

Zero Press ADD to auto zero.	Zero (20.9% O ₂) Press ADD to auto zero.
Non-O ₂ sensor	O ₂ sensor

2. Press the ADD button to begin the zero process and advance to the clean air confirmation screen.

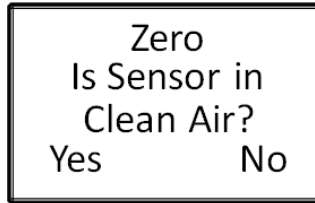

3. If the sensor is in clean air, press the ADD button to select “Yes” and continue to Step 5.
4. For CO₂ sensors or if the sensor is not in clear air:
 - a. Unscrew and remove the sensor housing cap from the assembly.

NOTE: A black spacer may be attached to the sensor after you remove the sensor housing cap. Remove the spacer from the sensor and screw it back into the sensor housing cap.

- b. Install the calibration cup to the AirLink Alert’s sensor housing base.
 - c. Screw the regulator into the zero air calibration cylinder (100% N₂ cylinder if zeroing a CO₂ sensor).
 - d. Use the sample tubing to connect the regulator to the calibration cup.
 - e. Turn the regulator knob counterclockwise to open the regulator.
 - f. Allow the gas to flow for 1 minute.
 - g. Press the ADD button to select “Yes” and continue to Step 5.
5. The unit will automatically begin the 12-second zero process. During the zero, the display will show a countdown of the time remaining until the process is complete.

NOTE: The zero process cannot be stopped without disconnecting the power from the unit.

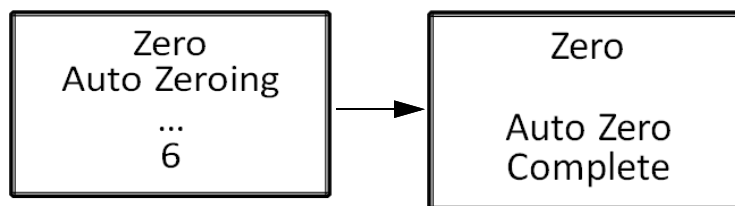

6. When the zero process is complete, press the MENU button to advance to the calibration screen.
7. If a zero air calibration cylinder (or 100% N₂ cylinder for CO₂ sensors) was used, turn the regulator knob clockwise to close the regulator.

Calibrating the Sensor (Manual Cal)

Either the Manual Cal screen or the Auto Cal screen appear, depending on how Calibration Method is set in the Product Settings and Configuration Menu (see page 29).

NOTE: LEL and CO₂ - LEL and CO₂ versions of the AirLink Alert can only be calibrated using Auto Cal (see the next section).

HCl - It is recommended that the HCl version only be calibrated using Auto Cal, but Manual Cal can be used if desired.

You should ONLY calibrate the sensor after completing the zero process.

Calibration Frequency

A calibration should be performed EVERY thirty (30) days. Days since the last calibration should NEVER exceed ninety (90) days. RKI recommends that you calibrate your device regularly to ensure proper functionality and a safe work environment.

Materials

- 0.5 LPM fixed flow regulator with knob and calibration tubing

WARNING: *If calibrating with Cl₂ or HCl, a regulator must be dedicated for use with that gas only. Do not use that dedicated regulator for any other gases, particularly H₂S.*

- calibration cup
- calibration cylinder or gas generator (For O₂ sensors, RKI recommends using 10-18% O₂. For all other sensors, RKI recommends using 50% of the full scale value of your detected gas.)

NOTE: Some detected gases use surrogate gases for calibration. Detected gases needing a surrogate gas for calibration are listed below. If you are using a surrogate gas for calibration, that surrogate gas concentration multiplied by the factor listed below should equal about 50% of the detected gas' full scale.

Table 4: Surrogate Calibration Gases

Detected Gas	Surrogate Calibration Gas	Factor
Arsine (AsH ₃)	Phospine (PH ₃)	1.4
Chlorine Dioxide (ClO ₂)	Chlorine (Cl ₂)	1
Formaldehyde (CH ₂ O)	Carbon Monoxide (CO)	0.2
Hydrogen Fluoride (HF)	Chlorine (Cl ₂)	7.5
Ozone (O ₃)	Chlorine (Cl ₂)	0.8
	Nitrogen Dioxide (NO ₂)	1

Procedure

1. For EtO calibration gas: Connect the tubing to the regulator, turn the regulator on, and allow gas to flow for **1 minute** before proceeding.

For HCl calibration gas: Connect the tubing to the regulator, turn the regulator on, and allow gas to flow for **10 minutes** before proceeding.

2. If you followed the instructions in Zeroing the Sensor (20.9% for O₂), the screen below is displayed.

If you are accessing Manual Cal from Normal Operating Mode, press MENU twice.

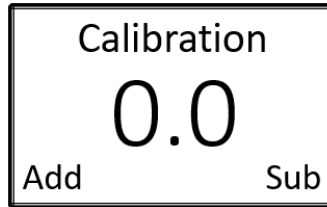

3. Unscrew and remove the sensor housing cap from the assembly.

NOTE: A black spacer may be attached to the sensor after you remove the sensor housing cap. Remove the spacer from the sensor and screw it back into the sensor housing cap.

4. Install the calibration cup to the AirLink Alert's sensor housing base.
5. Use the sample tubing to connect the regulator to the calibration cup.
6. For toxic gas cylinders, like Cl₂, it is important to vent the regulator while installing it onto the cylinder. Open the regulator by turning the knob counterclockwise and install it onto the cylinder.

WARNING: Be sure to use a breathing apparatus and to ventilate the area well when calibrating with high concentrations of toxic gases.

7. After 20-30 seconds, start using the ADD and SUB buttons to adjust the reading to match the concentration listed on the calibration cylinder.
8. For all calibration gases except Cl₂, ClO₂, EtO, and HCl: Let the gas flow for 1 minute.
For Cl₂ calibration gas: Let the gas flow for 3 minutes.
For ClO₂ calibration gas: Let the gas flow for 6 minutes.
For EtO calibration gas: Let the gas flow for 1.5 minutes.
For HCl calibration gas: Let the gas flow for 5 minutes.

9. Use the ADD and SUB buttons to finish adjusting the reading on the screen to match the concentration listed on the calibration cylinder.

For detectors using a surrogate gas, adjust the reading to match the surrogate gas concentration multiplied by the factor listed in Table 4 on page 35. Some versions will have to be set above full scale.

NOTE: Even if the reading does not need adjustment to match the calibration cylinder's concentration, you must adjust it up and then back down to reset the Cal field in the Zero/Calibration Timer Information screen.

10. When calibration is complete, remove the calibration cup from the sensor housing and reinstall the sensor housing cap.
11. Press the MENU button to scroll to the Sensor Address screen (see page 40).

Calibrating the Sensor (Auto Cal)

Either the Manual Cal screen or the Auto Cal screen appear, depending on how Calibration Method is set in the Product Settings and Configuration Menu (see page 29).

You should ONLY calibrate the sensor after completing the zero process.

NOTE: AsH₃ and HF - It is recommended that AsH₃ and HF versions only be calibrated using Manual Cal.

Calibration Frequency

A calibration should be performed EVERY thirty (30) days. Days since the last calibration should NEVER exceed ninety (90) days. RKI recommends that you calibrate your device regularly to ensure proper functionality and a safe work environment.

Materials

- 0.5 LPM fixed flow regulator with knob and calibration tubing

WARNING: *If calibrating with Cl₂ or HCl, a regulator must be dedicated for use with that gas only. Do not use that dedicated regulator for any other gases, particularly H₂S.*

- calibration cup
- calibration cylinder or gas generator (For O₂ sensors, RKI recommends using 10-18% O₂. For all other sensors, RKI recommends using 50% of the full scale value of your detected gas.)

NOTE: Some detected gases use surrogate gases for calibration. Detected gases needing a surrogate gas for calibration are listed below. If you are using a surrogate gas for calibration, that surrogate gas concentration multiplied by the factor listed below should equal about 50% of the detected gas' full scale.

Table 5: Surrogate Calibration Gases

Detected Gas	Surrogate Calibration Gas	Factor
Arsine (AsH ₃)	Phospine (PH ₃)	1.4
Chlorine Dioxide (ClO ₂)	Chlorine (Cl ₂)	1
Formaldehyde (CH ₂ O)	Carbon Monoxide (CO)	0.2
Hydrogen Fluoride (HF)	Chlorine (Cl ₂)	7.5
Ozone (O ₃)	Chlorine (Cl ₂)	0.8
	Nitrogen Dioxide (NO ₂)	1

Procedure

1. For EtO calibration gas: Connect the tubing to the regulator, turn the regulator on, and allow gas to flow for **1 minute** before proceeding.

For HCl calibration gas: Connect the tubing to the regulator, turn the regulator on, and allow gas to flow for **10 minutes** before proceeding.

2. If you followed the instructions in Zeroing the Sensor (20.9% for O₂), the screen below is displayed.

If you are accessing Auto Cal from Normal Operating Mode, press MENU twice.

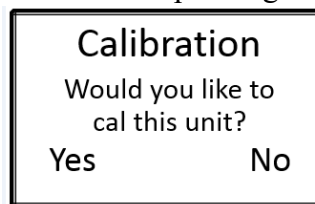

3. Press the ADD button to select "Yes" to begin the calibration process and to advance to the calibration confirmation screen. If you do not wish to calibrate the sensor, press the SUB button to select "No" to advance to the sensor radio address setting screen.

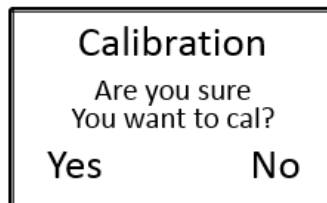

4. Press the ADD button to select “Yes” to confirm that you want to calibrate the sensor and to continue to the concentration setting screen. If you do not wish to continue to calibrate the sensor, press the SUB button to select “No” to advance to the sensor radio address setting screen.

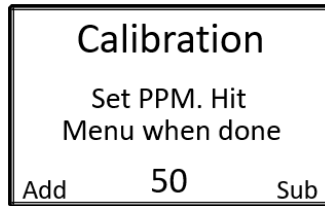

5. Use the ADD and SUB buttons to adjust the concentration match the concentration shown on the calibration cylinder.

For detectors using a surrogate gas, adjust the reading to match the surrogate gas concentration multiplied by the factor listed in Table 5 on page 38.

6. Press the MENU button to save the gas concentration setting and to advance to the calibration start screen.

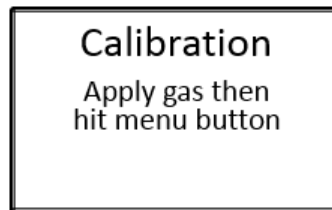

7. Unscrew and remove the sensor housing cap from the assembly.

NOTE: A black spacer may be attached to the sensor after you remove the sensor housing cap. Remove the spacer from the sensor and screw it back into the sensor housing cap.

8. Install the calibration cup to the AirLink Alert’s sensor housing base.
9. Use the sample tubing to connect the regulator to the calibration cup.
10. For toxic gas cylinders, like Cl₂, it is important to vent the regulator while installing it onto the cylinder. Open the regulator by turning the knob counterclockwise and install it onto the cylinder.

WARNING: *Be sure to use a breathing apparatus and to ventilate the area well when calibrating with high concentrations of toxic gases.*

11. Press the MENU button to begin calibrating the sensor. The unit automatically begins the calibration process. During calibration, the display shows a countdown of the time remaining until the process is complete. The amount of time varies based on the gas type.

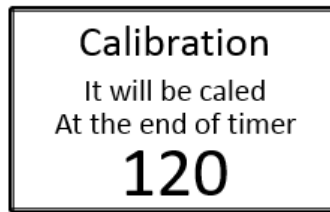

NOTE: Once the calibration countdown has started, the process cannot be stopped without disconnecting the power from the unit.

12. When calibration is complete, remove the calibration cup from the sensor housing and reinstall the sensor housing cap.

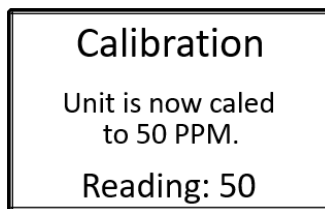

NOTE: If the sensor responds extremely slow, or does not respond to the applied gas, it may indicate a failed sensor element. The sensor element will need to be replaced before completing the zero and calibration process.

13. Turn the regulator knob clockwise to close the regulator.
14. Press the MENU button to scroll to the Radio Address screen.

Sensor Radio Address

The AirLink Alert radio address is adjustable from 1 to 255, each sensor assembly on the network needs a unique radio address in order to avoid a fault at the controller. The default radio address is 1.

1. From Normal Operating Mode, press and release MENU until the sensor radio address screen appears.

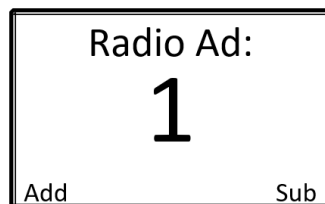

2. Use the ADD and SUB buttons to increase and decrease the sensor radio address, respectively.

3. Press the MENU button to save the desired setting and return to Normal Operating Mode.

NOTE: The alarms will NOT activate, even in the presence of gas, until you have been out of the Operation Settings menu for 1 minute. For auto resetting alarms, the alarms will NOT deactivate until the gas level reading at the sensor has fallen 10% below the alarm set-point.

Maintenance

RKI recommends that our equipment be calibrated a MINIMUM of every 90 days, and STRONGLY advise that calibration be performed every 30 days. Without knowing the specific application, sensor assembly location, gas exposure and other factors, the company recommends monthly calibrations – assuming no damage or potential damage has occurred to the sensor and that there has not been a power outage to the sensor assembly. If damage has occurred or the power supplied to the sensor has changed, a calibration should be completed immediately.

Scheduled maintenance should include the zero and calibration of the sensor (see page 33) and an alarm test (see page 25).

The sensor head should be kept free of airborne particles, dirt, mud, spider webs, bugs and insects, and/or any other debris that could potentially cover or coat the sensor. Keeping the sensor head clear of foreign articles will allow for proper operation of the device. A brief inspection during scheduled maintenance should suffice, but dependent upon the location and the environment in which the unit is installed, more frequent inspections may be warranted.

The AirLink Alert may be adversely affected by the exposure to certain airborne substances. Loss of sensitivity or corrosion may be gradual, if such materials are present in sufficient concentrations. The performance of the device may be impaired during operation in the presence of substances that can cause corrosion on gold plating. Continuous and high concentrations of corrosive gases may also have a detrimental long-term effect on the product's service life. The presence of such substances in an area does not preclude the use of this device, but makes a shortened sensor element lifetime more likely. Use of the sensor assembly in these environments may require more frequently scheduled maintenance to ensure safe and reliable system performance.

Troubleshooting

The troubleshooting guide describes symptoms, probable causes, and recommended action for problems you may encounter with the AirLink Alert.

NOTE: This troubleshooting guide describes AirLink Alert problems only. See the controller operator's manual for problems you may encounter with the controller.

Table 6: AirLink Alert Fault Codes

Problem	Cause(s)	Solution(s)
F4 Check Sensor Board	The control board has lost communication with the sensor interface board.	1. Replace the sensor interface board.
F5 Try to Zero Again	The unit did not zero correctly, due to: <ul style="list-style-type: none">• the presence of gas,• a sensor error, or• a sensor interface board error.	1. Re-zero the device in clear air. 2. Replace the sensor element. 3. Replace the sensor interface board.
F6 Try to Calibrate Again	The unit did not calibrate correctly, due to: <ul style="list-style-type: none">• the absence of gas,• a sensor error, or• a sensor interface board error.	1. Recalibrate the sensor element and verify that gas is present during calibration. 2. Replace the sensor element. 3. Replace the sensor interface board.
F14 Check Radio	The sensor assembly has lost communication with the Primary Monitor due to: <ul style="list-style-type: none">• Network ID is incorrectly configured.• Sensor assembly is obstructed/too far from the Primary Monitor.• Radio module is not working in the sensor assembly	1. Check that the Network ID on the sensor assembly matched the Primary Monitor Network ID. 2. Move the sensor assembly away from the obstruction or use a high gain antenna. 3. Replace sensor radio module.
Battery indicator is blank	Approximately 2 weeks of battery life remain.	Replace the battery pack soon.

Replacing the Desiccant

Each AirLink Alert comes with a desiccant bag installed in the junction box. The contents are blue when it is dry. As the desiccant absorbs moisture, it turns amber. Periodically check the desiccant and replace it if it has turned amber.

Replacing the Batteries

Under normal conditions, the AirLink Alert will operate for up to:

- Two years for electrochemical versions
- 10 - 12 months for LEL versions

- 14 days for PID versions

When the battery indicator is blank, approximately 2 weeks of battery life remain.

The presence of gas will increase the radio transmission rate and decrease this battery lifetime. It is recommended that the batteries be replaced when the voltage reported is 3.0 volts or less. See page 26 to determine the battery voltage. Batteries **SHOULD** be replaced in pairs and you should **NEVER** mix old and new batteries.

The AirLink Alert is able to operate with only one battery. However, the runtime of the unit will be reduced.

WARNING: *Only use RKI-supplied replacement batteries. Do not mix old and new batteries. Do NOT charge batteries.*

CAUTION: *The internal components can be static sensitive. Use caution when opening the enclosure and handling internal components. DO NOT use any metal objects or tools to remove the batteries.*

1. Press and hold the SUB button for approximately 6 seconds, until “OFF” shows on the display screen.
2. Unscrew the captive screws from the enclosure base. Remove the enclosure lid and set it aside.
3. Grab the front panel handles and gently lift the internal system out of the enclosure. It can rest on the edge of the enclosure.

CAUTION: *Be sure power to the AirLink Alert is off before pulling out the internal system.*

NOTE: Disconnecting the sensor connector plug from the sensor housing connector and the antenna fitting will allow for the complete removal of the internal system from the device enclosure. Disconnecting the internal system may provide ease in accessing the control board terminals for wiring. Reconnect the sensor connector plug before reinstalling the internal system.

4. Locate the battery connectors on the terminal board assembly. Squeeze the locking tab on one battery plug and gently pull it straight out of the battery connector. Repeat this step for the second battery plug and connector.

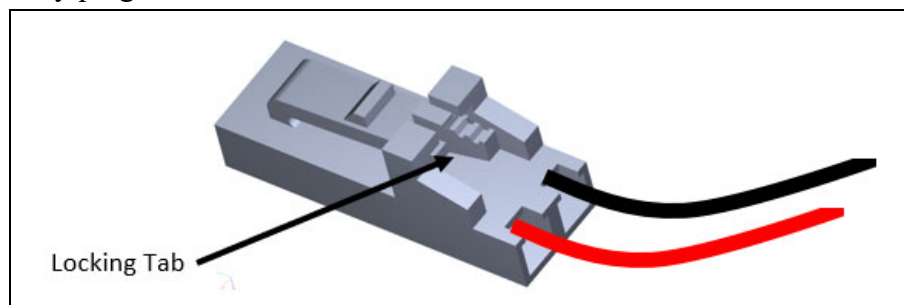

5. Gently remove the batteries from the battery spring clips.
6. Gently slide the new batteries into the spring clips in the same orientation as the old batteries.
7. Plug the battery on the bottom of the radio board into the closer 2-pin battery terminal.
8. Plug the battery on the top of the radio board into the other available 2-pin battery terminal.
9. Place the internal system back into the enclosure, matching each mounting post to its corresponding eyelet anchored within the base of the enclosure.
10. Using the front panel handles, gently push to seat the internal system into the mounting posts.
11. Reinstall the enclosure lid by tightly screwing the captive screws into the enclosure base.
12. Press the ADD button to initiate the 1-minute startup (3.5 minutes for LEL versions).
13. Allow the detector to warmup for the appropriate amount of time as shown below, depending on the sensor type.

Detection Gas	Warmup Time
Ammonia	4 hours
Arsine	10 minutes
Carbon Dioxide	
Carbon Monoxide	
Chlorine	
Chlorine Dioxide	
Combustible Gas	
Ethylene Oxide	
Formaldehyde	
Hydrogen	
Hydrogen Chloride	
Hydrogen Cyanide	
Hydrogen Fluoride	
Hydrogen Sulfide	
Nitric Oxide	
Nitrogen Dioxide	
Oxygen	
Ozone	
Phosphine	
Sulfur Dioxide	
VOCs	

14. Zero and calibrate the AirLink Alert as described on page 33.

Cleaning the 10.0 eV or 10.6 eV PID Lamp

WARNING: *Do not remove the sensor housing cap or enclosure lid while the circuits are energized unless the area is determined to be non-hazardous. Keep the sensor housing cap and enclosure lid tightly closed during operation.*

CAUTION: *The internal components can be static sensitive. Use caution when opening the enclosure and handling internal components. DO NOT use any metal objects or tools to remove the sensor.*

Clean the 10.0 eV or 10.6 eV lamp if you notice a significant drop in sensitivity from one scheduled calibration to another or if you are not able to calibrate the detector.

11.7 eV lamps should not be cleaned because of their susceptibility to moisture.

Cleaning Kit

The lamp cleaning kits for the 10.0 eV and 10.6 eV lamps include:

- an electrode stack removal tool
- a small vial of aluminum oxide powder
- 40 cotton swabs
- 10 finger cots

Lamp Cleaning Procedure

1. Press and hold the SUB button for approximately 6 seconds, until “OFF” shows on the display screen.
2. Unscrew and remove the sensor housing cap from the sensor housing base. Set aside.

NOTE: A black spacer may be attached to the sensor after you remove the sensor housing cap. Remove the spacer from the sensor and screw it back into the sensor housing cap.

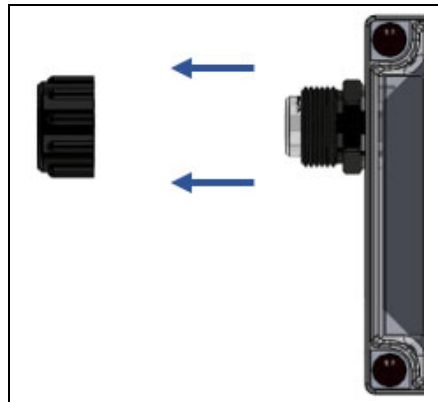

3. Gently unplug the sensor element from the sensor housing board.

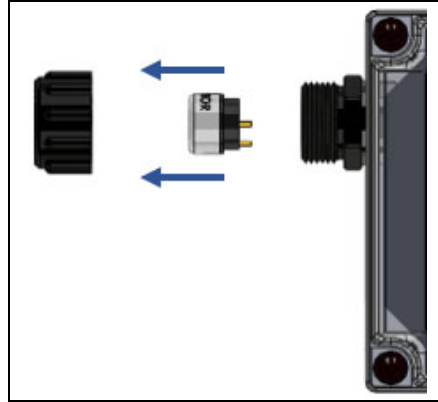

4. Place the PID sensor face down on a flat clean working surface.
5. Do not touch the lamp window with your fingers as this may contaminate the window with finger oil. At this point it is recommended that the finger cots be used on the fingers handling the lamp. Finger cots are included with the lamp cleaning kit.
6. Hold the PID sensor steady on the working surface with one hand and using the other hand, locate the tabs on the electrode stack removal tool and insert them into the slots on the side of the PID sensor near the face.



Figure 7: Using Removal Tool

7. Squeeze the removal tool to push the tabs into the sensor slots until the electrode stack and lamp are released.
8. Carefully lift the PID sensor body away from the electrode stack and lamp. Take care not to touch the lamp window, the flat end of the lamp, with your fingers. If the lamp remains lodged in the sensor body, carefully remove it with tweezers.

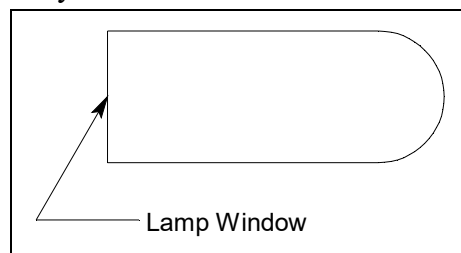

Figure 8: Lamp Window Location

9. If the spring in the lamp cavity comes out, place it back into the lamp cavity.

10. Hold the lamp in one hand being careful not to touch the lamp window with your fingers.
11. With the other hand collect a small amount of aluminum oxide powder on a cotton swab.
12. Use this cotton swab to polish the PID lamp window. Use a circular motion, applying light pressure to clean the lamp window. Do not touch the lamp window with your fingers.



Figure 9: Polishing the Electrode Lamp Window

13. Continue polishing until you can hear a squeaking sound made by the cotton swab moving over the window surface. This usually occurs after about 15 seconds of polishing.
14. Remove the residual powder from the lamp window with a clean cotton swab. Take care not to touch the tip of the cotton swab that is used to clean the lamp as this may contaminate it with finger oil.
15. Ensure the lamp is completely dry and any visible signs of contamination are removed before reinstalling.
16. Hold the electrode stack between the thumb and forefinger of one hand and place the window end of the lamp inside the O-ring seal in the electrode stack with the other hand as shown below.

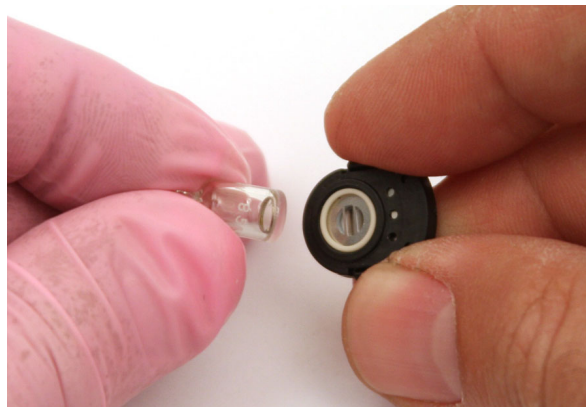
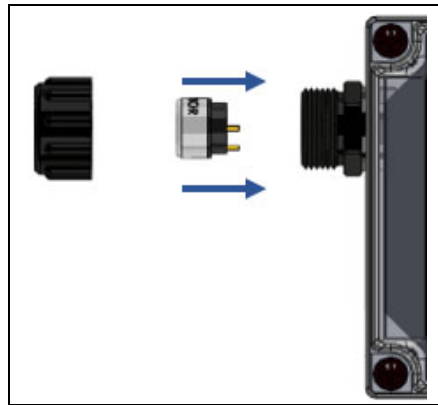

Figure 10: Reinstalling the Electrode Lamp

17. Twisting the lamp slightly during insertion will help to ensure the lamp window is snug against the stack's front electrode. The lamp should be supported by the O-ring.
18. Continuing to hold the electrode stack between your forefinger and thumb, carefully insert the lamp into the lamp cavity in the sensor ensuring that the lamp remains in position.

19. Press in the electrode stack firmly to ensure that the stack wing clips are engaged and the faces of the stack and sensor body are flush.
20. Plug the sensor element into the sensor housing board. Ensure that the pins on the sensing element align with the sockets on the sensor housing board.



21. Screw the sensor housing cap back onto the sensor housing base, ensuring that the sensor housing cap is only tightened hand tight.

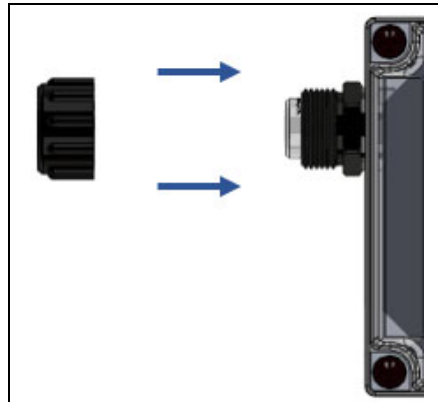

22. Press the ADD button to turn the AirLink Alert on.
23. Wait 10 minutes and then zero and calibrate the detector as described on page 33.

Replacing the PID Lamp

WARNING: *Do not remove the sensor housing cap or enclosure lid while the circuits are energized unless the area is determined to be non-hazardous. Keep the sensor housing cap and enclosure lid tightly closed during operation.*

CAUTION: *The internal components can be static sensitive. Use caution when opening the enclosure and handling internal components. DO NOT use any metal objects or tools to remove the sensor.*

If cleaning the PID lamp does not resolve any calibration problems you may be having, the lamp may need to be replaced.

Ordering the Correct Replacement Lamp

It's important to order the correct replacement lamp for your PID sensor.

1. Look at the part number label on the side of your PID sensor.
2. See the table below for replacement lamp part numbers based on your sensor's part number.

Table 7: PID Sensor Replacement Lamp Part Number

Sensor Part Number	Replacement Lamp Part Number
61-0302	51-1503
61-0303	
61-0304	
61-0305	51-1504

Lamp Replacement Procedure

NOTE: Do not touch the new lamp window (the flat end) with your fingers as this may contaminate the window with finger oil.

1. Press and hold the SUB button for approximately 6 seconds, until "OFF" shows on the display screen.

2. Unscrew and remove the sensor housing cap from the sensor housing base. Set aside.

NOTE: A black spacer may be attached to the sensor after you remove the sensor housing cap. Remove the spacer from the sensor and screw it back into the sensor housing cap.

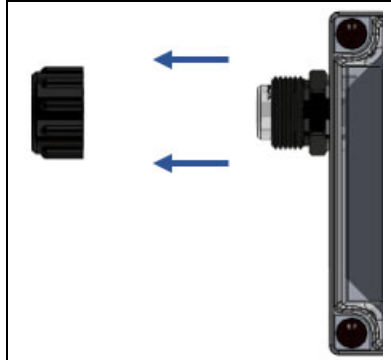

3. Gently unplug the sensor element from the sensor housing board.

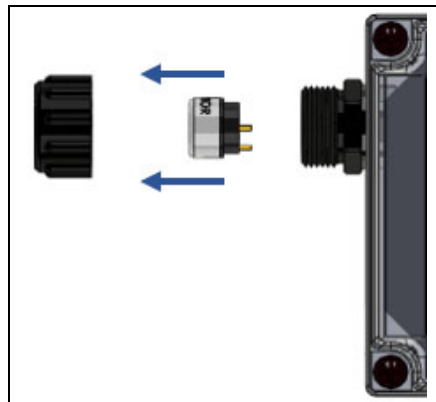

4. Place the PID sensor face down on a flat clean working surface.
5. Hold the PID sensor steady on the working surface with one hand and using the other hand, locate the tabs on the electrode stack removal tool and insert them into the slots on the side of the PID sensor near the face.



Figure 11: Using Removal Tool

6. Squeeze the removal tool to push the tabs into the sensor slots until the electrode stack and lamp are released.
7. Carefully lift the PID sensor body away from the electrode stack and lamp. If the lamp remains lodged in the sensor body, carefully remove it with tweezers.
8. If the spring in the lamp cavity comes out, place it back into the lamp cavity.
9. Discard the old PID lamp.

NOTE: At this point it is recommended that the finger cots be used on the fingers handling the lamp. Finger cots are included with the lamp cleaning kit.

10. Hold the electrode stack between the thumb and forefinger of one hand and place the window end of the new lamp inside the O-ring seal in the electrode stack with the other hand as shown below. Take care not to touch the lamp window.

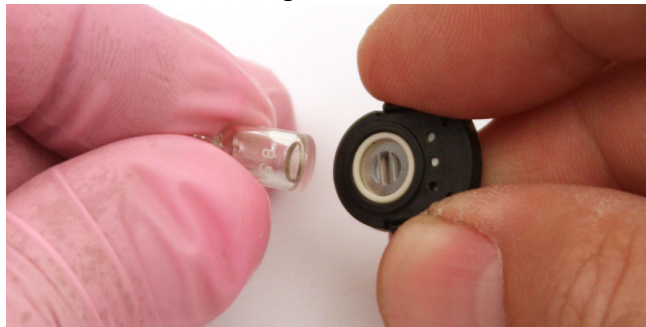
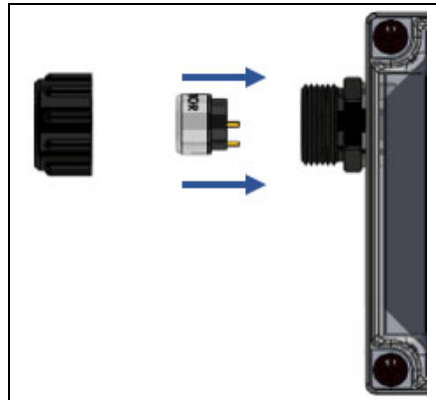
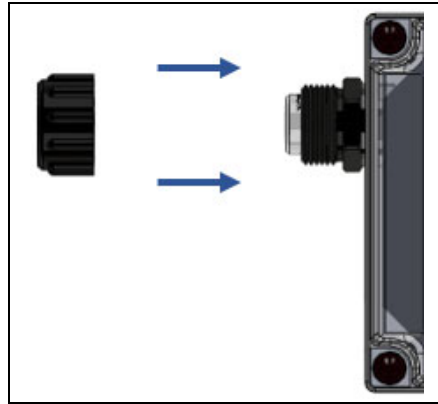

Figure 12: Reinstalling the Electrode Lamp

11. Twisting the lamp slightly during insertion will help to ensure the lamp window is snug against the stack's front electrode. The lamp should be supported by the O-ring.
12. Continuing to hold the electrode stack between your forefinger and thumb, carefully insert the lamp into the lamp cavity in the sensor ensuring that the lamp remains in position.
13. Press in the electrode stack firmly to ensure that the stack wing clips are engaged and the faces of the stack and sensor body are flush.
14. Plug the sensor element into the sensor housing board. Ensure that the pins on the sensing element align with the sockets on the sensor housing board.



15. Screw the sensor housing cap back onto the sensor housing base, ensuring that the sensor housing cap is only tightened hand tight.



16. Press the ADD button to turn the AirLink Alert on.
17. Wait 10 minutes and then zero and calibrate the detector as described on page 33.

Replacing the PID Electrode Stack

WARNING: *Do not remove the sensor housing cap or enclosure lid while the circuits are energized unless the area is determined to be non-hazardous. Keep the sensor housing cap and enclosure lid tightly closed during operation.*

CAUTION: *The internal components can be static sensitive. Use caution when opening the enclosure and handling internal components. DO NOT use any metal objects or tools to remove the sensor.*

The electrode stack can last for the life of the PID sensor if the AirLink Alert is used in a very clean, controlled environment. When used in a heavily contaminated or dirty environment, the electrode stack may only last a month. A contaminated electrode stack will cause a drop in sensitivity which can cause problems calibrating the PID channel. The electrode stack should be replaced if the PID sensor shows signs of contamination even after cleaning or replacing the lamp.

NOTE: Do not touch the new lamp window (the flat end) with your fingers as this may contaminate the window with finger oil.

1. Press and hold the SUB button for approximately 6 seconds, until “OFF” shows on the display screen.

2. Unscrew and remove the sensor housing cap from the sensor housing base. Set aside.

NOTE: A black spacer may be attached to the sensor after you remove the sensor housing cap. Remove the spacer from the sensor and screw it back into the sensor housing cap.

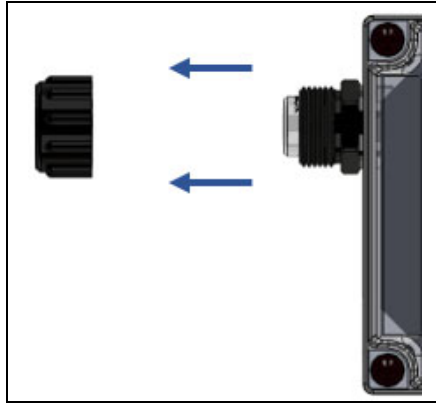

3. Gently unplug the sensor element from the sensor housing board.

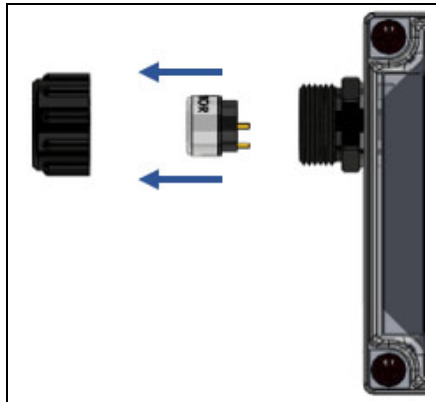

4. Place the PID sensor face down on a flat clean working surface.

NOTE: At this point it is recommended that the finger cots be used on the fingers handling the lamp. Finger cots are included with the lamp cleaning kit.

5. Hold the PID sensor steady on the working surface with one hand and using the other hand, locate the tabs on the electrode stack removal tool and insert them into the slots on the side of the PID sensor near the face.



Figure 13: Using Removal Tool

6. Squeeze the removal tool to push the tabs into the sensor slots until the electrode stack and lamp are released.
7. Carefully lift the PID sensor body away from the electrode stack and lamp. If the lamp remains lodged in the sensor body, carefully remove it with tweezers.
8. If the spring in the lamp cavity comes out, place it back into the lamp cavity.
9. Discard the old electrode stack.
10. Hold the new electrode stack between the thumb and forefinger of one hand and place the window end of the lamp inside the O-ring seal in the new electrode stack with the other hand as shown below. Take care not to touch the lamp window.



Figure 14: Reinstalling Electrode Lamp

11. Twisting the lamp slightly during insertion will help to ensure the lamp window is snug against the stack's front electrode. The lamp should be supported by the O-ring.
12. Continuing to hold the electrode stack between your forefinger and thumb, carefully insert the lamp into the lamp cavity in the sensor ensuring that the lamp remains in position.
13. Press in the electrode stack firmly to ensure that the stack wing clips are engaged and the faces of the stack and sensor body are flush.

14. Plug the sensor element into the sensor housing board. Ensure that the pins on the sensing element align with the sockets on the sensor housing board.

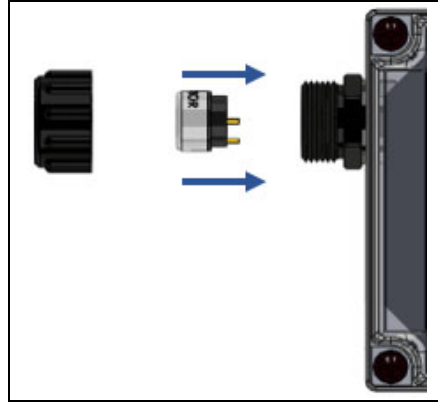

15. Screw the sensor housing cap back onto the sensor housing base, ensuring that the sensor housing cap is only tightened hand tight.

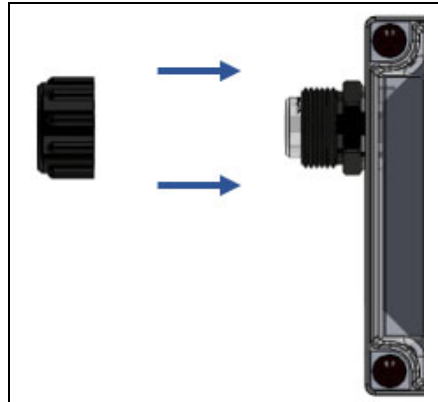

16. Press the ADD button to turn the AirLink Alert on.

17. Wait 10 minutes and then zero and calibrate the detector as described on page 33.

Replacing the Sensor

RKI recommends replacing the sensor element whenever a slow response to gas is observed during the normal calibration process. After replacing the sensor element, the device **MUST** be zeroed and calibrated for proper operation of the device.

CAUTION: *The internal components can be static sensitive. Use caution when opening the enclosure and handling internal components. DO NOT use any metal objects or tools to remove the sensing element from the sensor adapter board.*

1. Press and hold the SUB button for approximately 6 seconds, until “OFF” shows on the display screen.
2. Unscrew and remove the sensor housing cap from the sensor housing base. Set aside.

NOTE: A black spacer may be attached to the sensor after you remove the sensor housing cap. Remove the spacer from the sensor and screw it back into the sensor housing cap.

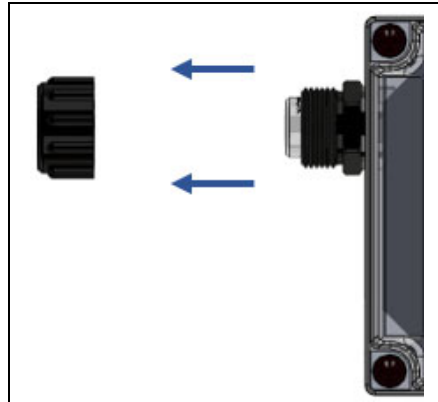

3. Gently unplug the sensor element from the sensor housing board.

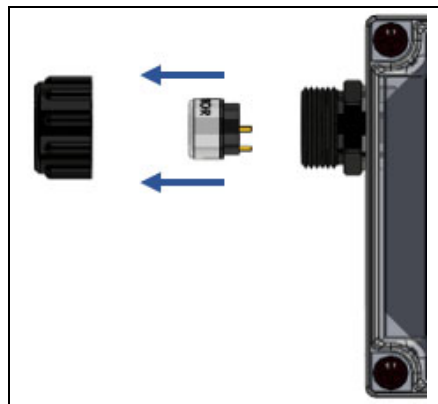

4. Plug the new sensor element into the sensor housing board. Ensure that the pins on the sensing element align with the sockets on the sensor housing board.

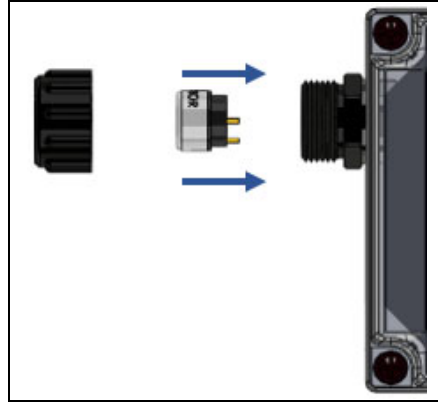

5. Screw the sensor housing cap back onto the sensor housing base, ensuring that the sensor housing cap is only tightened hand tight.

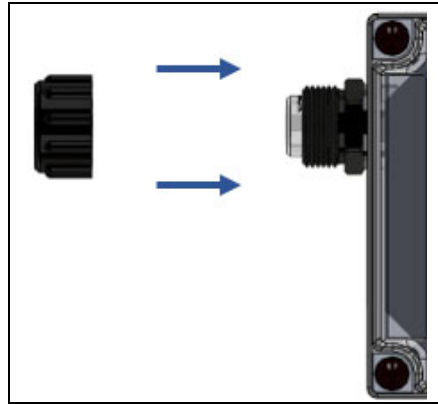

6. Press the ADD button to turn the AirLink Alert on.
7. Allow the detector to warmup for the appropriate amount of time as shown below, depending on the sensor type.

Detection Gas	Warmup Time
Ammonia (NH ₃)	12 hours
Arsine (AsH ₃)	2 hours
Carbon Dioxide (CO ₂)	10 minutes
Carbon Monoxide (CO)	2 hours
Chlorine (Cl ₂)	
Chlorine Dioxide (ClO ₂)	
Combustible Gas	10 minutes
Ethylene Oxide (EtO)	48 hours
Formaldehyde (CH ₂ O)	10 minutes
Hydrogen (H ₂)	2 hours

Detection Gas	Warmup Time
Hydrogen Chloride (HCl)	12 hours
Hydrogen Cyanide (HCN)	
Hydrogen Fluoride (HF)	2 hours
Hydrogen Sulfide (H ₂ S)	
Nitric Oxide (NO)	72 hours
Nitrogen Dioxide (NO ₂)	2 hours
Oxygen (O ₂)	
Ozone (O ₃)	
Phosphine (PH ₃)	
Sulfur Dioxide (SO ₂)	
VOCs	
	10 minutes

8. Zero and calibrate the detector as described on page 33.

Replacing the Fuse

CAUTION: *The internal components can be static sensitive. Use caution when opening the enclosure and handling internal components. DO NOT use any metal objects or tools to remove the batteries.*

1. Press and hold the SUB button for approximately 6 seconds, until “OFF” shows on the display screen.
2. Unscrew the captive screws from the enclosure base. Remove the enclosure lid and set it aside.
3. Grab the front panel handles and gently lift the internal system out of the enclosure. It can rest on the edge of the enclosure.

CAUTION: *Be sure power to the AirLink Alert is off before pulling out the internal system.*

NOTE: Disconnecting the sensor connector plug from the sensor housing connector and the antenna fitting will allow for the complete removal of the internal system from the device enclosure. Disconnecting the internal system may provide ease in accessing the control board terminals for wiring. Reconnect the sensor connector plug before reinstalling the internal system.

4. Locate the fuse that needs to be replaced.

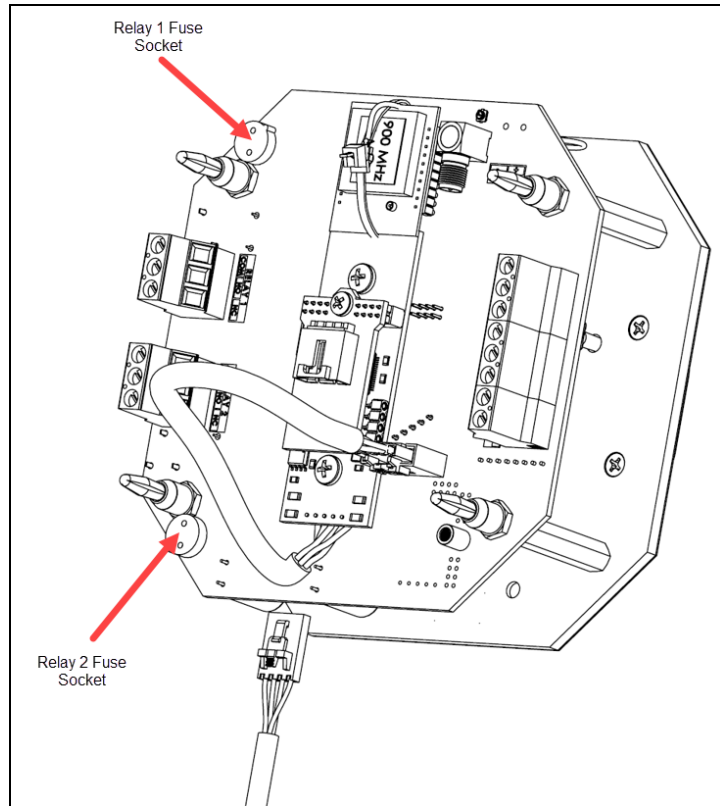

5. Pull the old fuse straight out.
6. Align the pins on the replacement fuse with the sockets in the fuse holder.
7. Push the new fuse into the fuse holder.
8. Place the internal system back into the enclosure, matching each mounting post to its corresponding eyelet anchored within the base of the enclosure.
9. Using the front panel handles, gently push to seat the internal system into the mounting posts.
10. Reinstall the enclosure lid by tightly screwing the captive screws into the enclosure base.
11. Press the ADD button to initiate the 1-minute startup (3.5 minutes for LEL versions).
12. Allow the detector to warmup for the appropriate amount of time as shown below, depending on the sensor type.

Detection Gas	Warmup Time
Ammonia	4 hours
Arsine	10 minutes
Carbon Dioxide	
Carbon Monoxide	
Chlorine	

Detection Gas	Warmup Time
Chlorine Dioxide	10 minutes
Combustible Gas	
Ethylene Oxide	
Formaldehyde	
Hydrogen	
Hydrogen Chloride	
Hydrogen Cyanide	
Hydrogen Fluoride	
Hydrogen Sulfide	
Nitric Oxide	
Nitrogen Dioxide	
Oxygen	
Ozone	
Phosphine	
Sulfur Dioxide	
VOCs	

13. Zero and calibrate the AirLink Alert as described on page 33.

Parts List

Table 8 lists replacement parts and accessories for the AirLink Alert.

Table 8: Parts List

Part Number	Description
09-0300RK	Desiccant bag
43-4163	Fuse, 4A
47-5110-7-XX	Cable with connector for remote-mounted kit (specify length in 1-foot increment when ordering; maximum lengths listed on page 7), 7-pin
47-5111-XX	Cable with connectors for remote-mounted antenna (specify length when ordering; choices are 5, 10, 15, 25, 50, 75, 100 ft)
49-1416-01	Single battery with connector (need 2 if replacing both batteries)
51-1503	PID sensor replacement lamp, for 10.0 eV, low range 10.6 eV, and high range 10.6 eV sensors
51-1504	PID sensor replacement lamp, 11.7 eV sensor
61-0302	10.6 eV low range replacement sensor, with lamp and stack
61-0303	10.6 eV high range replacement sensor, with lamp and stack
61-0304	11.7 eV replacement sensor, with lamp and stack
61-0305	10.0 eV replacement sensor, with lamp and stack
61-2002	Remote sensor mounting kit, 7-pin non-explosion-proof
66-0001	Sensor, carbon monoxide (CO), for up to 1,000 ppm full scale
66-0002	Sensor, oxygen (O ₂), 25% volume full scale
66-0003-1	Sensor, hydrogen sulfide (H ₂ S), for up to 100 ppm full scale
66-0003-2	Sensor, hydrogen sulfide (H ₂ S), for 200 to 2,000 ppm full scale
66-0004-1	Sensor, hydrogen chloride (HCl), for up to 20 ppm full scale
66-0004-2	Sensor, hydrogen chloride (HCl), for up to 100 ppm full scale
66-0005	Sensor, hydrogen cyanide (HCN), 50 ppm full scale
66-0006N-1	Sensor, ammonia (NH ₃), for up to 100 ppm full scale
66-0006N-2	Sensor, ammonia (NH ₃), for 200 to 1,000 ppm full scale
66-0007	Sensor, nitric oxide (NO), for up to 250 ppm full scale
66-0008	Sensor, nitrogen dioxide (NO ₂), 20 ppm full scale
66-0009-1	Sensor, ozone (O ₃), for up to 5 ppm full scale
66-0009-2	Sensor, ozone (O ₃), for 10 to 1,000 ppm full scale

Table 8: Parts List

Part Number	Description
66-0010	Sensor, sulfur dioxide (SO ₂), 20 ppm full scale
66-0011	Sensor, formaldehyde (CH ₂ O), 10 ppm full scale
66-0012	Sensor, chlorine (Cl ₂), for up to 20 ppm full scale
66-0013	Sensor, chlorine dioxide (ClO ₂), for up to 5 ppm full scale
66-0014	Sensor, hydrogen fluoride (HF), 10 ppm full scale
66-0015	Sensor, phosphine (PH ₃), 5 ppm full scale
66-0016	Sensor, ethylene oxide (EtO), 10 ppm full scale
66-0039	Sensor, hydrogen (H ₂), 100% LEL full scale
66-0060	Sensor, methane, LPIR type, 100% LEL full scale
66-0063	Sensor, general hydrocarbons, LPIR type, 100% LEL full scale
66-0067	Sensor, carbon dioxide (CO ₂), LPIR type, 5.0% volume full scale
66-0068	Sensor, arsine (AsH ₃), 1.00 ppm full scale
71-0557	AirLink Alert Operator's Manual (this document)
81-0002RK-01	Calibration cylinder, 50% LEL (2% volume) hydrogen in air, 34 liter steel
81-0002RK-03	Calibration cylinder, 50% LEL (2% volume) hydrogen in air, 103 liter
81-0004RK-01	Calibration cylinder, 50% LEL propane in air, 34 liter steel
81-0004RK-03	Calibration cylinder, 50% LEL propane in air, 103 liter
81-0007RK-01	Calibration cylinder, 15% LEL hexane in air, 34 liter steel
81-0010RK-01	Calibration cylinder, 10% LEL (5000 ppm) methane in air, 34 liter steel
81-0010RK-03	Calibration cylinder, 10% LEL (5000 ppm) methane in air, 103 liter
81-0012RK-01	Calibration cylinder, 50% LEL methane in air, 34 liter steel
81-0012RK-03	Calibration cylinder, 50% LEL methane in air, 103 liter
81-0064RK-01	Calibration cylinder, 50 ppm CO in air, 34 liter steel
81-0064RK-03	Calibration cylinder, 50 ppm CO in air, 103 liter
81-0069RK-01	Calibration cylinder, 200 ppm CO in air, 34 liter steel
81-0069RK-03	Calibration cylinder, 200 ppm CO in air, 103 liter
81-0072RK-01	Calibration cylinder, 2.5% CO ₂ in air, 34 liter steel
81-0072RK-03	Calibration cylinder, 2.5% CO ₂ in air, 103 liter
81-0076RK	Zero air calibration cylinder, 17 liter
81-0076RK-01	Zero air calibration cylinder, 34 liter steel

Table 8: Parts List

Part Number	Description
81-0076RK-03	Zero air calibration cylinder, 103 liter
81-0078RK-01	Calibration cylinder, 100% nitrogen, 34 liter steel
81-0078RK-03	Calibration cylinder, 100% nitrogen, 103 liter
81-0100RK-04	Calibration cylinder, 5 ppm benzene in air, 34 liter aluminum
81-0103RK-04	Calibration cylinder, 100 ppm isobutylene in air, 34 liter aluminum
81-0104RK-04	Calibration cylinder, 10 ppm isobutylene in air, 34 liter aluminum
81-0146RK-02	Calibration cylinder, 200 ppm H ₂ S in nitrogen, 58 liter
81-0149RK-02	Calibration cylinder, 5 ppm H ₂ S in nitrogen, 58 liter
81-0149RK-04	Calibration cylinder, 5 ppm H ₂ S in nitrogen, 34 liter aluminum
81-0150RK-02	Calibration cylinder, 10 ppm H ₂ S in nitrogen, 58 liter
81-0150RK-04	Calibration cylinder, 10 ppm H ₂ S in nitrogen, 34 liter aluminum
81-0151RK-02	Calibration cylinder, 25 ppm H ₂ S in nitrogen, 58 liter
81-0151RK-04	Calibration cylinder, 25 ppm H ₂ S in nitrogen, 34 liter aluminum
81-0170RK-02	Calibration cylinder, 5 ppm SO ₂ in nitrogen, 58 liter
81-0170RK-04	Calibration cylinder, 5 ppm SO ₂ in nitrogen, 34 liter aluminum
81-0174RK-02	Calibration cylinder, 50 ppm NH ₃ in nitrogen, 58 liter
81-0176RK-02	Calibration cylinder, 25 ppm NH ₃ in nitrogen, 58 liter
81-0176RK-04	Calibration cylinder, 25 ppm NH ₃ in nitrogen, 34 liter aluminum
81-0180RK-02	Calibration cylinder, 10 ppm NO ₂ in nitrogen, 58 liter
81-0180RK-04	Calibration cylinder, 10 ppm NO ₂ in nitrogen, 34 liter aluminum
81-0181RK-02	Calibration cylinder, 25 ppm NO in nitrogen, 58 liter
81-0181RK-04	Calibration cylinder, 25 ppm NO in nitrogen, 34 liter aluminum
81-0185RK-02	Calibration cylinder, 0.5 ppm PH ₃ in nitrogen, 58 liter
81-0185RK-04	Calibration cylinder, 0.5 ppm PH ₃ in nitrogen, 34 liter aluminum
81-0190RK-02	Calibration cylinder, 5 ppm Cl ₂ in nitrogen, 58 liter
81-0190RK-04	Calibration cylinder, 5 ppm Cl ₂ in nitrogen, 34 liter aluminum
81-0192RK-02	Calibration cylinder, 2 ppm Cl ₂ in nitrogen, 58 liter
81-0192RK-04	Calibration cylinder, 2 ppm Cl ₂ in nitrogen, 34 liter aluminum
81-0194RK-02	Calibration cylinder, 10 ppm HCl in nitrogen, 58 liter
81-0196RK-02	Calibration cylinder, 10 ppm HCN in nitrogen, 58 liter

Table 8: Parts List

Part Number	Description
81-0196RK-04	Calibration cylinder, 10 ppm HCN in nitrogen, 34 liter aluminum
81-1050RK	Regulator with gauge and knob, 0.5 LPM, for 17 liter and 34 liter steel calibration cylinders (cylinders with external threads)
81-1051RK	Regulator with gauge and knob, 0.5 LPM, for 34 liter aluminum, 58 liter, and 103 liter calibration cylinders (cylinders with internal threads)
81-1185	Calibration cup with 3 foot tube, for all gases except refrigerants
81-1186	Calibration cup, for refrigerants
81-9029RK-02	Calibration cylinder, 100 ppm NH ₃ in N ₂ , 58 liter
81-9029RK-04	Calibration cylinder, 100 ppm NH ₃ in N ₂ , 34 liter aluminum
81-9062RK-04	Calibration cylinder, 5 ppm EtO in air, 34 liter aluminum
81-9090RK-01	Calibration cylinder, 12% O ₂ in N ₂ , 34 liter steel
81-9090RK-03	Calibration cylinder, 12% O ₂ in N ₂ , 103 liter
82-0003RK	Electrode stack removal tool
82-0104	Magnetic wand
82-0300RK	Aluminum oxide powder PID lamp cleaning kit, with electrode stack removal tool, for 10.0 eV and 10.6 eV PID sensors' lamps ONLY