



INSTRUMENTS

EAGLE 3

Operator's Manual

Part Number: 71-0590

Revision: P1

Released: 5/13/26

WARNING

Read and understand this instruction manual before operating instrument. Improper use of the gas monitor could result in bodily harm or death.

Maintenance of the gas monitor is essential for proper operation and correct readings.

Bump test the instrument before each day's use with a known concentration of each target gas. A bump test can be done in User Mode's BUMP item or by applying gas in Measuring Mode. The instrument does not need to be calibrated unless it does not pass the User Mode bump test or does not respond appropriately, as defined by the user, in Measuring Mode. For more information about bump test and calibration requirements, see IEC 60079-29-2.

Table of Contents

Chapter 1: Introduction	12
About the EAGLE 3	12
Specifications	13
About this Manual	13
Chapter 2: Description	16
Instrument Description	16
<i>LCD</i>	18
<i>Case</i>	18
<i>Control Buttons</i>	18
<i>Alarm LEDs</i>	19
<i>Buzzer</i>	19
<i>Sensors</i>	19
<i>Filters</i>	22
<i>Printed Circuit Boards (PCBs)</i>	22
<i>Flow System</i>	23
<i>Battery Pack</i>	24
Standard Accessories	24
<i>Shoulder Strap</i>	24
<i>Hose and Probe</i>	25
<i>AC Charger</i>	26
Optional Accessories	26
<i>Optional Probes</i>	26
<i>External Dilution Fittings</i>	28
Chapter 3: Operation	30
Start Up	30
<i>Turning On the EAGLE 3</i>	30
<i>Performing a Demand Zero</i>	41
<i>Turning Off the EAGLE 3</i>	42

Normal Mode Operation.....	43
<i>Monitoring an Area</i>	44
<i>Using Optional Sample Hoses</i>	45
<i>Using Exhaust Tubing</i>	45
<i>Combustible Gas Detection</i>	45
<i>Monitoring Combustible Gas in the PPM or % volume Ranges</i>	48
Alarms	52
<i>Alarm Indicators</i>	52
<i>Responding to Alarms</i>	54
Data Logging	58
Chapter 4: Display Mode.....	59
Tips for Using Display Mode	59
Peak Screen	60
Battery Voltage Screen	61
Catalytic (LEL) Sensor Screen.....	61
Methane Elimination Mode Screen	63
Relative Response Screen	64
STEL Screen	66
TWA Screen	66
View Alarm Settings Screen	67
Viewing and Selecting the User ID	69
Viewing and Selecting the Station ID	70
View Snap Log Data Screen	73
Time in Operation Screen	76
Date/Time Screen	76
Data Logging Screen	77
Chapter 5: Calibration Mode	79
Overview	79
Entering Calibration Mode	79
Performing a Bump Test	80
Preparing for a Calibration	87

Calibrating Using the Auto Calibration Method	87
<i>Setting the Fresh Air Reading</i>	90
<i>Performing a Span Adjustment in Auto Calibration</i>	91
Chapter 6: Maintenance	97
Overview	97
Troubleshooting	97
Recharging the EAGLE 3	99
Replacing the Hydrophobic Probe's Hydrophobic Filter Disk	100
Replacing the Hydrophobic Filter	101
Replacing the Sensor Filters	103
Checking the Combustible Gas Sensor's Condition	104
Sensor Replacement	104
<i>Replacing an O₂, CO, H₂S, and LEL Sensor</i>	104
<i>Replacing F-Sensors</i>	107
Chapter 7: Storage and Disposal	108
Chapter 8: General Parts List	109
Appendix A: Setup Mode	111
Overview	111
Tips for Using Setup Mode	117
Entering Setup Mode	117
Setting the Date and Time (Set Date/Time)	118
Setting the Date Format (Set Date Format)	119
Configuring the Channels (Configure Channels)	121
Configuring the Gases (Configure Gases)	123
<i>Adjusting Target Gas for Catalytic Sensors</i>	124
<i>Adjusting Channels for Non-Catalytic Sensors</i>	125
Setting the Catalytic Detection Units	125
Setting the LEL Standard	126
Adjusting the Relative Response Setting	127
Updating the Alarm Settings	128
<i>Changing Alarm Points</i>	128
<i>Changing the Alarm Latching Setting</i>	131

<i>Turning the Buzzer Silence Setting On or Off</i>	132
<i>Turning the Sensor Life Alert On or Off</i>	133
<i>Saving the User Alarm Settings</i>	134
<i>Restoring the User Alarm Settings</i>	135
<i>Restoring the 4 Gas Alarm Settings</i>	136
<i>Restoring the Factory Alarm Settings</i>	137
Turning the User and Station ID On or Off	138
Turning Demand Zero On or Off (Demand Zero)	139
Turning Auto Zero On or Off (Auto Zero)	140
Turning CO2 Air Zero On or Off	141
Adjusting the Data Log Settings	142
<i>Selecting the Data Log Interval</i>	142
<i>Turning Data Log Overwrite On or Off</i>	143
Selecting the Backlight Time	144
Adjusting the LCD Contrast	145
Turning the Key Tone On/Off	146
Calibration Settings	147
<i>Turning the Calibration Reminder On or Off</i>	147
<i>Selecting the Calibration Past Due Action Setting</i>	148
<i>Adjusting the Calibration Interval</i>	149
<i>Turning Life Span On or Off</i>	150
<i>Turning Calibration Auto Start On or Off</i>	150
Bump Test Settings	151
<i>Turning Bump Reminder On or Off</i>	151
<i>Selecting the Bump Past Due Action</i>	153
<i>Adjusting the Bump Test Interval</i>	154
<i>Turning Bump Auto Start On or Off</i>	155
<i>Selecting the Gas Time</i>	156
<i>Adjusting the Tolerance</i>	157
<i>Selecting the Calibration Time</i>	158
<i>Turning Auto Calibration On or Off</i>	159
Setting the Mode Select	162
Setting the Bar Hole Measurement Time	163
Adjusting the CO Display In Leak Check	164

Adjusting the Zero Follower Settings	165
Adjusting the Zero Suppression Settings	168
Adjusting the Confirmation Alert Setting	170
Turning Stealth Mode On or Off	173
Turning Lunch Break On or Off	174
Adjusting the Language Setting	175
Setting the Calibration Mode Password	176
Turning the Setup Password Function On or Off	176
Enabling the Flow Checking	177
Low Flow Fail Calibration	178
Viewing the Software Version	180
Adjusting the Radio Standard	181
Saving the User Configuration	182
Restoring the User Configuration	183
Restoring the Four Gas Defaults	184
Restoring the Factory Defaults	186
Exiting Setup Mode (Normal Operation)	187
Appendix B: Calibrating with a Sample Bag	188
Overview	188
Calibration Supplies and Equipment	188
Sample Bag Calibration Parts List	190
Appendix C: PID Sensors	191
Overview	191
Description	191
<i>PID Sensor and Sensor Adapter</i>	192
<i>PID Probe</i>	192
Start Up and Normal Operation	192
PID Relative Response Feature	194
<i>PID Sensor Relative Response Screen in Display Mode</i>	194
PID Calibration	196

Maintenance	197
<i>Troubleshooting</i>	197
<i>Cleaning the PID Sensor's Lamp</i>	197
<i>Replacing PID Sensor's Lamp</i>	201
<i>Replacing Electrode Stack</i>	205
<i>Replacing the PID Sensor</i>	209
Configuring the PID Gas in Setup Mode	211
Parts List	211
Appendix D: ESF Toxic Sensors	212
Overview	212
Description	212
<i>ESF Sensor</i>	215
Start Up and Normal Operation	215
ESF Calibration	215
Maintenance	216
<i>Replacing the ESF Sensor</i>	216
Parts List	217
Appendix E: TC Sensors	219
Overview	219
Description	219
<i>TC Sensor</i>	220
Start Up and Normal Operation	220
Catalytic (LEL) Sensor Screen	220
TC Calibration	221
Maintenance	221
<i>Replacing the TC Sensor</i>	221
Configuring the TC Gas in Setup Mode	223
Parts List	225
Appendix F: Infrared Carbon Dioxide Sensors	226
Overview	226

Description	227
<i>Infrared Carbon Dioxide Sensor</i>	227
<i>CO₂ Scrubber</i>	228
Start Up and Normal Operation	228
<i>Performing a Demand Zero for Carbon Dioxide Sensors</i>	228
Infrared Carbon Dioxide Calibration	229
Maintenance	229
<i>Replacing the IR CO₂ Sensor or Changing Sensor Type</i>	229
Parts List	231
Appendix G: Infrared Methane Sensor	232
Overview	232
<i>Target Gases</i>	232
Description	233
<i>Infrared Methane Sensor</i>	233
Start Up and Normal Operation	233
<i>Detection Ranges</i>	234
Catalytic (LEL) Sensor Screen	234
Infrared Methane Calibration	235
Maintenance	235
<i>Replacing the IR Methane Sensor</i>	235
Parts List	237
Appendix H: Infrared Hydrocarbon Sensor	238
Overview	238
<i>Target Gases</i>	238
Description	238
<i>Infrared Hydrocarbon Sensor</i>	239
Start Up and Normal Operation	239
<i>0-100% LEL/2.0-30.0% vol Autoranging</i>	239
Catalytic (LEL) Sensor Screen	240
Infrared Hydrocarbon Calibration	240
Maintenance	241
<i>Replacing the IR Hydrocarbon Sensor</i>	241
Parts List	243

Appendix I: Methane Elimination Mode	244
Overview	244
Monitoring in Methane Elimination Mode	244
Calibration	246
Appendix J: Using the EAGLE 3 in Bar Hole Mode	248
Overview	248
Start Up, Bar Hole Mode	248
<i>Turning on EAGLE 3, Bar Hole Mode</i>	248
<i>Performing a Demand Zero, Bar Hole Mode</i>	254
Bar Hole Testing	254
<i>Performing a Bar Hole Test</i>	254
<i>Turning off the EAGLE 3, Bar Hole Mode</i>	256
Appendix K: Using the EAGLE 3 in Leak Check Mode	257
Overview	257
Start Up, Leak Check Mode	257
<i>Turning On the EAGLE 3, Leak Check Mode</i>	257
<i>Performing a Demand Zero, Leak Check Mode</i>	262
Leak Testing	263
<i>Locating a Leak</i>	263
<i>Turning the Buzzer On and Off In Leak Check Mode</i>	263
<i>Turning Off the EAGLE 3, Leak Check Mode</i>	264
Appendix L: Using the EAGLE 3 in Inert Mode	265
Description	265
Alarms	265
Start Up	267
Operation	268
Appendix M: EAGLE 3 Transformer Gas Tester Model	269
Description	269
Operation	269
Alarms	269
Parts List	270

Appendix N: Internal Dilution Models 271

 Description 271

 Calibration 271

Product Warranty 272

WARNING: *Understand manual before operating. Substitution of components may impair intrinsic safety. To prevent ignition of a hazardous atmosphere, batteries must only be changed or charged in an area known to be nonhazardous. Not tested in oxygen enriched atmospheres (above 21%).*

NOTE: RKI Instruments, Inc. recommends that you refer to ISA-RP12.13, Part II-1987 or an equivalent international recommended practice for guidance in the use of combustible gas detection instruments.

CAUTION: *Protection is impaired if the instrument is used in a manner not specified by the manufacturer.*

Chapter 1: Introduction

About the EAGLE 3

Using an advanced detection system consisting of up to six gas sensors, the EAGLE 3 sample draw gas monitor can detect the presence of combustible gas, oxygen (O₂), carbon monoxide (CO), hydrogen sulfide (H₂S), and toxic gases simultaneously.

The EAGLE 3's rugged, reliable, and easy-to-use design makes it suited for a wide range of applications, including sewage treatment plants, utility manholes, tunnels, hazardous waste sites, power stations, petrochemical refineries, mines, paper mills, drilling rigs, and fire fighting stations. The EAGLE 3's full range of features is included below:

- Simultaneous monitoring of one to six gases. The standard configuration includes four sensors for combustible gas (%LEL, ppm, and %volume), oxygen (O₂), carbon monoxide (CO), and hydrogen sulfide (H₂S).
- Choice of three operating modes:
 - Normal Mode for typical confined spaces or area monitoring (standard factory setting)
 - Bar Hole Mode for checking of bar holes when searching for underground gas leaks
 - Leak Check Mode for locating leaks in valves and piping
- Sample-drawing pump with a range of up to 125 feet
- Liquid crystal display (LCD) for complete and understandable information at a glance
- Ultrabright alarm LEDs
- Distinctive audible alarm for dangerous gas conditions or unit malfunction
- Microprocessor control for reliability, ease of use, and advanced capabilities
- Data logging functions (when used in Normal Mode)
- Alarm trend data (when used in Normal Mode)
- STEL and TWA (when used in Normal Mode) and over range alarms
- Peak readings (when used in Normal Mode)
- Built-in time function
- Lunch break feature
- RF shielded high-impact plastic case
- (Pending) CSA classified for Class I, Division I, Groups A, B, C, and D hazardous atmospheres

WARNING: The Model EAGLE 3 detects oxygen deficiency, elevated levels of oxygen, combustible gases, carbon monoxide, and hydrogen sulfide, all of which can be dangerous or life threatening. When using the EAGLE 3, you must follow the instructions and warnings in this manual to ensure proper and safe operation of the unit and to minimize the risk of personal injury. Be sure to maintain and periodically calibrate the EAGLE 3 as described in this manual.

NOTE: ONLY THE COMBUSTIBLE GAS DETECTION PORTION OF THIS INSTRUMENT HAS BEEN ASSESSED FOR PERFORMANCE.

Specifications

Table 1: Standard Sensor Specifications

	Detection Range	Lower Detectable Limit (LDL)	Reading Increment	Alarm 1 Setpoint	Alarm 2 Setpoint	STEL Setpoint	TWA Setpoint
Combustible Gas (CH ₄ Cal Standard)	0 - 100% LEL	n/a	1% LEL	10% LEL	50% LEL	n/a	n/a
Oxygen (O ₂)	0 - 40.0% vol	n/a	0.1% vol	19.5% vol	23.5% vol	n/a	n/a
Hydrogen Sulfide (H ₂ S)	0 - 200.0 ppm	0.5 ppm	0.5 ppm	5.0 ppm	30.0 ppm	5.0 ppm	1.0 ppm
Carbon Monoxide (CO)	0 - 2,000 ppm	3 ppm	1 ppm	25 ppm	50 ppm	200 ppm	25 ppm

Specifications for Non-Standard Sensors

- For PID sensors, see “PID Sensor Specifications” on page 191.
- For ESF sensors, see “ESF Detection Specifications” on page 212.
- For TC sensors, see “TC Sensor Specifications” on page 219.
- For IR CO₂ sensors, see “Infrared CO₂ Sensor Specifications” on page 226.
- For IR CH₄ sensors, see the specification tables starting on page 232.
- For IR hydrocarbon sensors, see the specification tables on page 238.

Table 2: Instrument Specifications

Sampling Method	Sample Draw
Display	Graphics LCD Display
Response Times	<ul style="list-style-type: none"> • <u>O₂ Sensor</u>: T90 within 20 seconds • <u>H₂S Sensor</u>: T90 within 30 seconds • <u>CO and CO(-H₂) Sensor</u>: T90 within 30 seconds • <u>LEL Sensor</u>: T90 within 60 seconds • <u>ESF Sensors</u>: See Table 22, “ESF Detection Specifications,” on page 212 • <u>PID, TC, and IR Sensors</u>: T90 within 30 seconds

Table 2: Instrument Specifications

Operating Temperature(s)	All sensors with target gases except those listed below:	-20°C to 50°C	
	<ul style="list-style-type: none"> • Hydrogen Bromide (HBr) • Hydrogen Chloride (HCl) • Fluorine (F2) 	<ul style="list-style-type: none"> • Hydrogen Fluoride (HF) • Chlorine Trifluoride (ClF3) 	0°C to 40°C
	<ul style="list-style-type: none"> • Chlorine (Cl2) 		0°C to 50°C
	<ul style="list-style-type: none"> • Ozone (O3) 		10°C to 40°C
Humidity	Below 85% RH (Non-Condensing)		
Indicator Accuracy*	<u>Combustible Gas (LEL), Catalytic Type Sensor</u> <ul style="list-style-type: none"> • -10°C to 40°C: 5% of full scale • -20°C to 50°C: 6% of full scale <u>Oxygen (O₂) Sensor</u> <ul style="list-style-type: none"> • 0 - 25.0%: ± 0.5% O₂ • 25.1 - 40.0%: ± 3.0% O₂ <u>Hydrogen Sulfide (H₂S) Sensor</u> <ul style="list-style-type: none"> • 0 - 100.0 ppm: ± 5% of reading or ± 2 ppm H₂S (whichever is greater) • 100.1 - 200 ppm: ± 20% of reading <u>Carbon Monoxide (CO) Sensor</u> <ul style="list-style-type: none"> • 0 - 500 ppm: ± 5% of reading or ± 15 ppm CO (whichever is greater) • 501 - 2000 ppm: ± 20% of reading 		
Safety/Regulatory	ATEX Pending CSA Pending		
IP Rating	IP54		
Power Supply	Lithium-ion battery pack		
Continuous Operating Hours @ 25 °C	Non-Alarm Operation, Fully Charged 30 Hours (Standard 4-gas Version)		
Battery Charger Ratings	Input: 100 - 240 VAC, 50 - 60 Hz, 0.4 A Output: 5.0 VDC, 2.5A, 12.5W		
Case	High-impact Plastic, RF-shielded, Dust and Weather Proof		
Standard Accessories	<ul style="list-style-type: none"> • AC charger • 5-foot hose • Hydrophobic probe • Shoulder strap 		
Optional Accessories	<ul style="list-style-type: none"> • Hoses of Various Lengths, see “Chapter 8: General Parts List” on page 109. • Dilution Fitting (1:1 and 3:1) • Various Probes, see “Chapter 8: General Parts List” on page 109 • Data/communication USB cable 		

Table 2: Instrument Specifications

Dimensions and Weight	Approximately 270 mm (H) x 120 mm (W) x 160 mm (D) (10.6" H x 4.7" W x 6.3" D) Approximately 1.54 kg (3.4 lbs)
------------------------------	---

* Indication accuracy specifications are measured at constant conditions.

About this Manual

The EAGLE 3 Operator's Manual uses the following conventions for notes, cautions, and warnings.

NOTE: Describes additional or critical information.

CAUTION: Describes potential damage to equipment.

WARNING: Describes potential danger that can result in injury or death.



Refer to accompanying documentation.

Button Labels

Throughout this manual, the EAGLE 3's control buttons are referenced in the following ways:

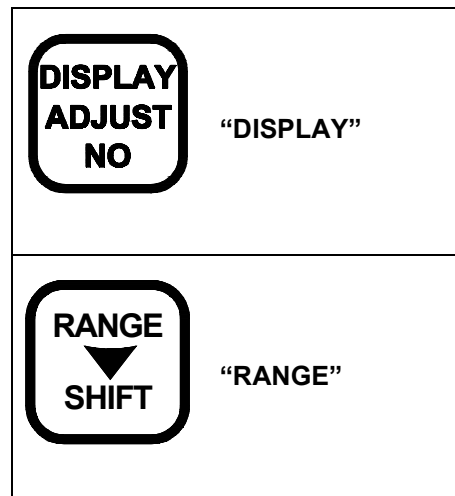
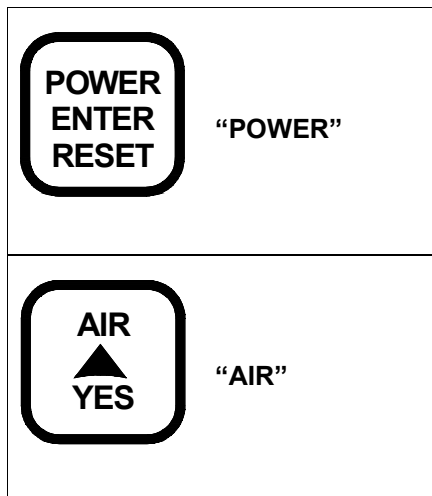

Chapter 2: Description

Instrument Description

The EAGLE 3 includes the case, LCD, control buttons, alarm LEDs, buzzer, sensors, printed circuit boards, communication port, flow system, and rechargeable battery pack.

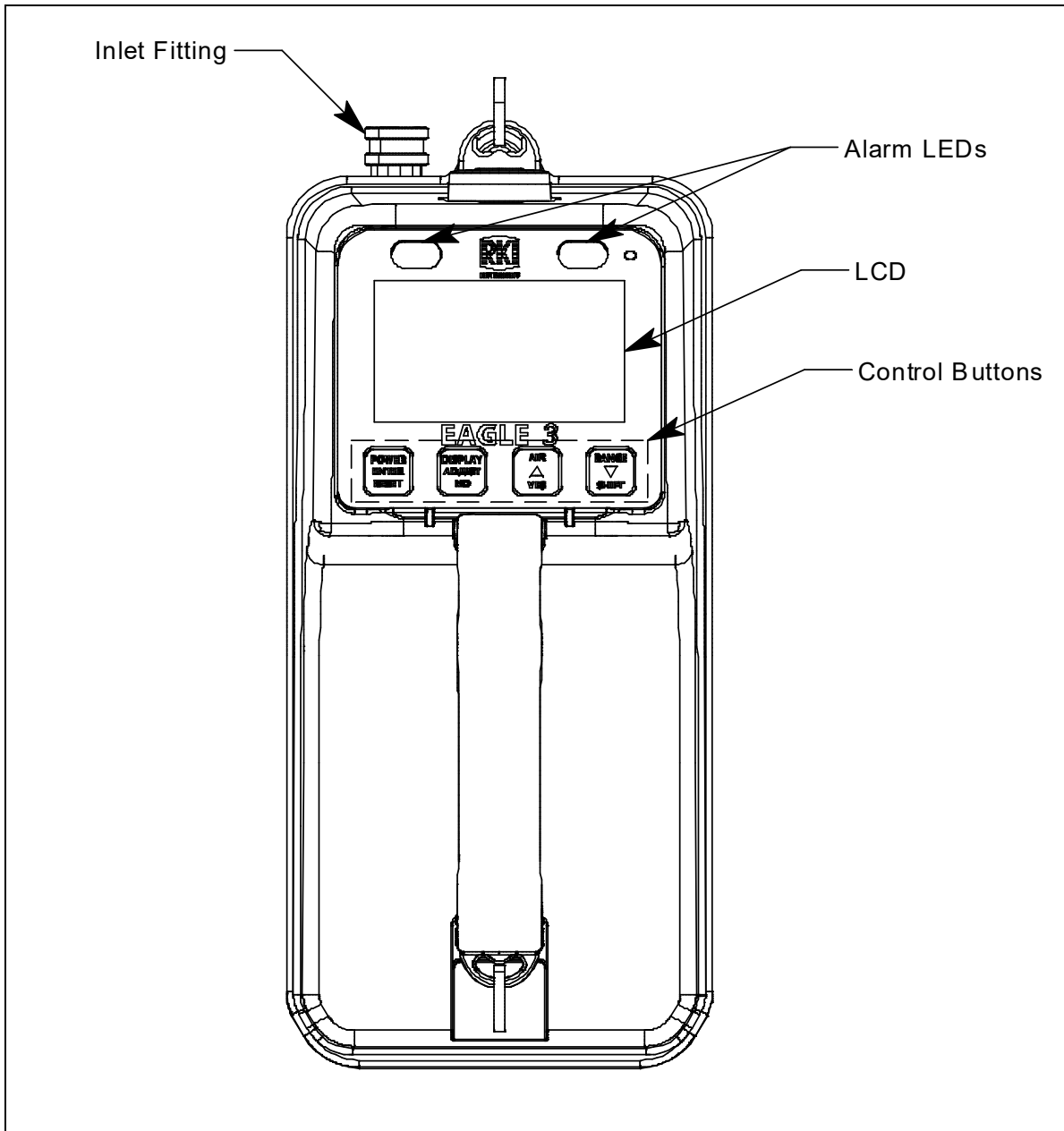

Figure 1: Component Location, Top View

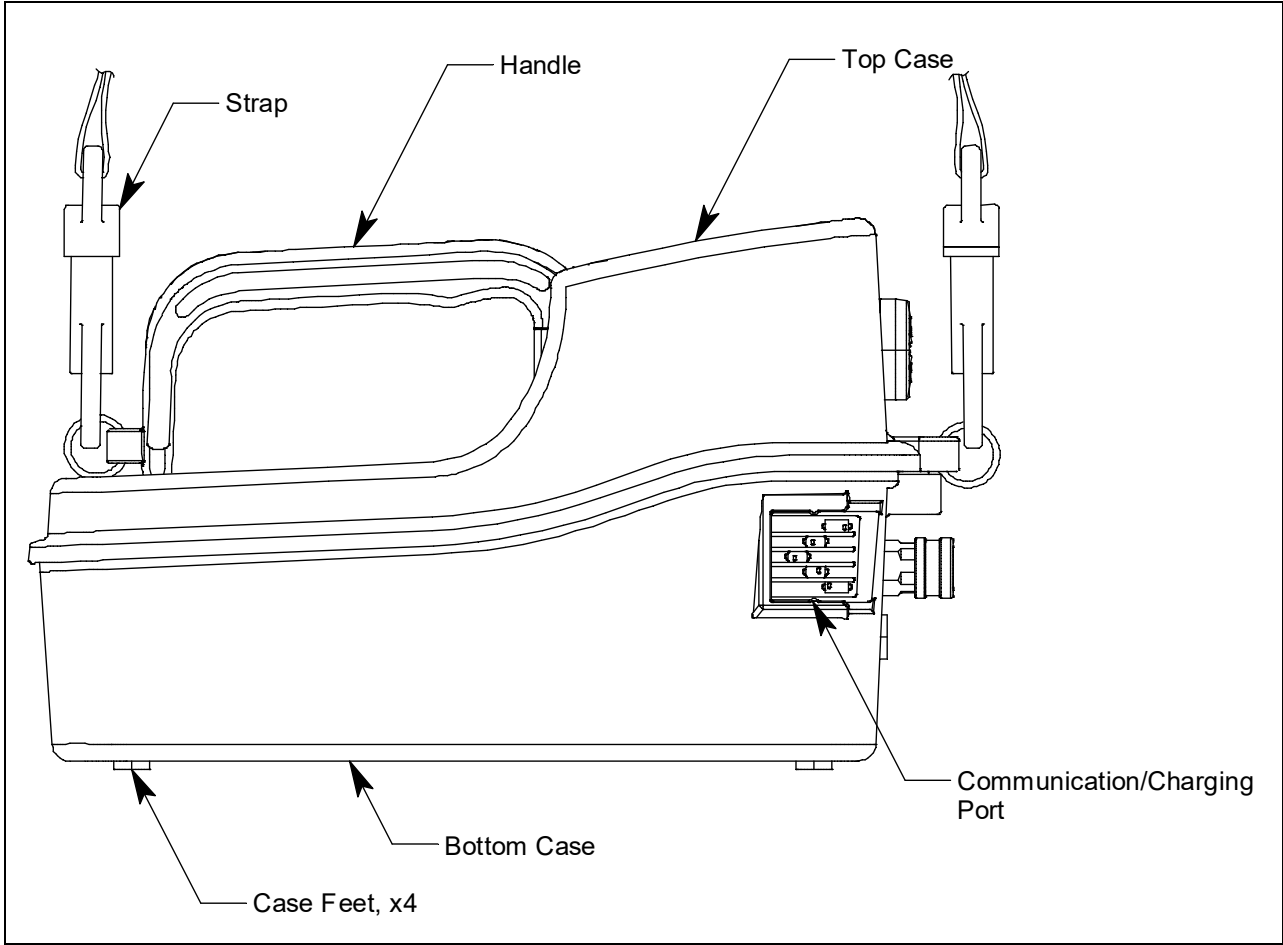

Figure 2: Component Location, Side View

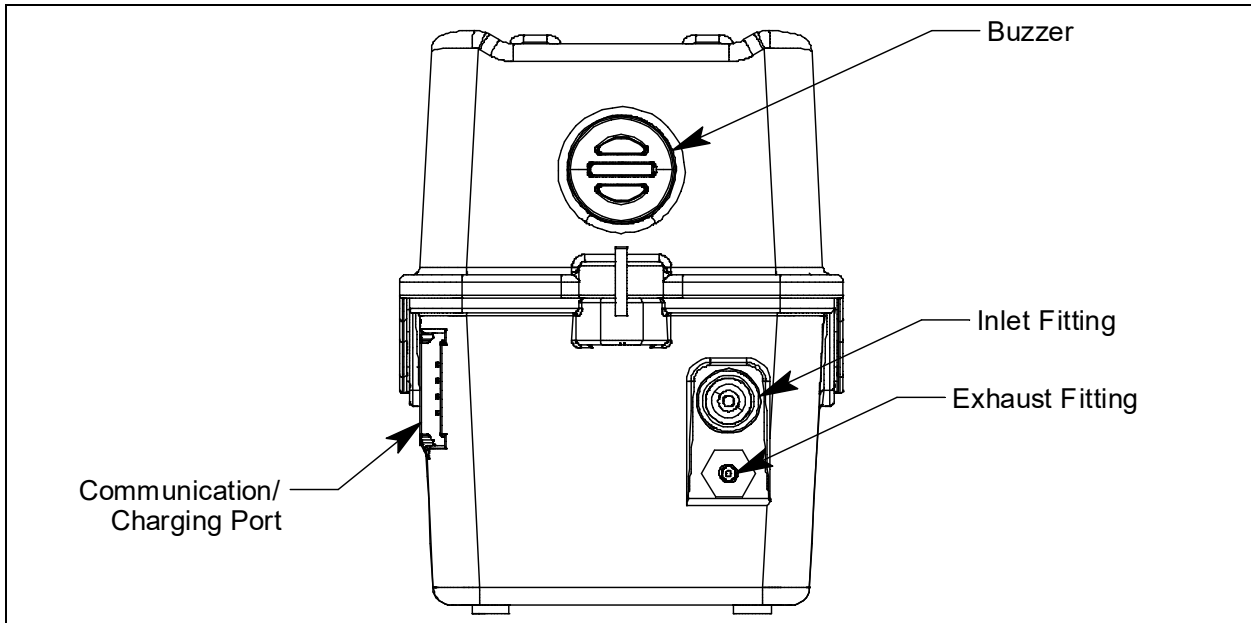

Figure 3: Component Location, Front View

Case

The EAGLE 3's high-impact, conductive plastic case is radio frequency (RF) resistant and suitable for many indoor and outdoor conditions. The case is dust-proof and water-resistant. Its two main components, the top case and bottom case, are held together with three screws located on the bottom case. The interface between the top case and bottom case is gasketed. A sturdy, well-balanced handle on the top case makes the instrument comfortable to hold. A clear plastic window for viewing the LCD is located above the black handle on the top case.

There are four, raised feet on the bottom of the bottom case. These slightly elevate the EAGLE 3 from the surface on which it rests.

LCD

A digital LCD (liquid crystal display) is visible through a clear plastic window in the top case. The LCD simultaneously shows the gas readings for all installed sensors. The LCD also shows information for each of the EAGLE 3's operating modes.



A backlight allows the LCD to remain visible in low-light situations. The backlight is set on a timer to switch off after a certain period to prolong battery life. This setting can be adjusted from 0 seconds to 10 minutes using the **Backlight Time** parameter in **Setup Mode** (see page 144).



NOTE: If **Stealth** is set to **On**, the backlight remains off regardless of the **Backlight Time** setting.

WARNING: *A thin protective film covers the display to prevent scratches during shipping. Remove this film before use. Leaving the film installed voids the intrinsically safe certification.*

Control Buttons

From left to right, the four control buttons below the LCD are POWER (ENTER RESET), DISPLAY (ADJUST NO), AIR (▲YES), and RANGE (▼SHIFT).

Button	Function(s)
	<ul style="list-style-type: none">• turns the EAGLE 3 on and off• silences and resets alarm condition if Alarm Latching is set to Enabled and Buzzer Silence is set to On• enters instructions, values, and settings into the EAGLE 3's microprocessor
	<ul style="list-style-type: none">• enters and scrolls through Display Mode• silences and resets alarm condition if Alarm Latching is set to Enabled and Buzzer Silence is set to On• enters instructions into the EAGLE 3's microprocessor

Button	Function(s)
	<ul style="list-style-type: none"> • activates the demand zero function (adjusts the EAGLE 3's fresh air reading) • silences and resets alarm condition if Alarm Latching is set to Enabled and Buzzer Silence is set to On • enters instructions into the EAGLE 3's microprocessor • moves the cursor on the LCD up the screen • increases the value of a parameter available for adjustment • scrolls through parameter options
	<ul style="list-style-type: none"> • changes the detection units of the combustible gas channel (when Catalytic Units is set to Change OK in Setup Mode) • silences and resets alarm condition if Alarm Latching is set to Enabled and Buzzer Silence is set to On • enters instructions into the EAGLE 3's microprocessor • moves the cursor on the LCD down the screen • decreases the value of a parameter available for adjustment • scrolls through parameter options

Alarm LEDs

Five sets of red alarm LEDs (light emitting diodes) around the edge of the case act as visual indicators for gas, low battery, and failure alarms.

Charging Indicator LED

One LED located above the LCD lights up red when a power cable is plugged into the instrument. When charging is complete, the LED turns green until the EAGLE 3 is disconnected from power.

Buzzer

One solid-state electronic buzzer is located inside the case. Sound exits the case through a hole in the middle front of the case. The buzzer sounds for gas alarms, malfunctions, low battery voltage, and as a general indicator while the EAGLE 3 is in use.

Sensors

The EAGLE 3 can use up to six sensors to simultaneously monitor combustible gas, oxygen (O₂), carbon monoxide (CO), hydrogen sulfide (H₂S), and other toxic gases. The sensors are located inside the EAGLE 3's bottom case, installed in the flow chamber. The O₂, CO, and H₂S sensors are housed within a flow block mounted to the main board.

CAUTION: Indication accuracy may be reduced when used in high-humidity or low-humidity environments.

Indication accuracy may be reduced if the temperature varies significantly after adjustment at a high or low temperature.

The reading may fluctuate if the temperature, humidity, or pressure varies suddenly.

CAUTION: Never disassemble the sensor. Electrochemical type sensors contain hazardous electrolyte.

Sensors will not operate if installed in the wrong direction. Forcibly installing sensors may damage the sensors and main unit. This may also cause the sensors to fail.

The LEL sensor and all F-sensors are installed into individual flow blocks mounted to the bottom plate of the unit (see Figure 4). Each F sensor is secured in place by retainers that have sensor adapter PCBs that connect sensors to the main PCB.

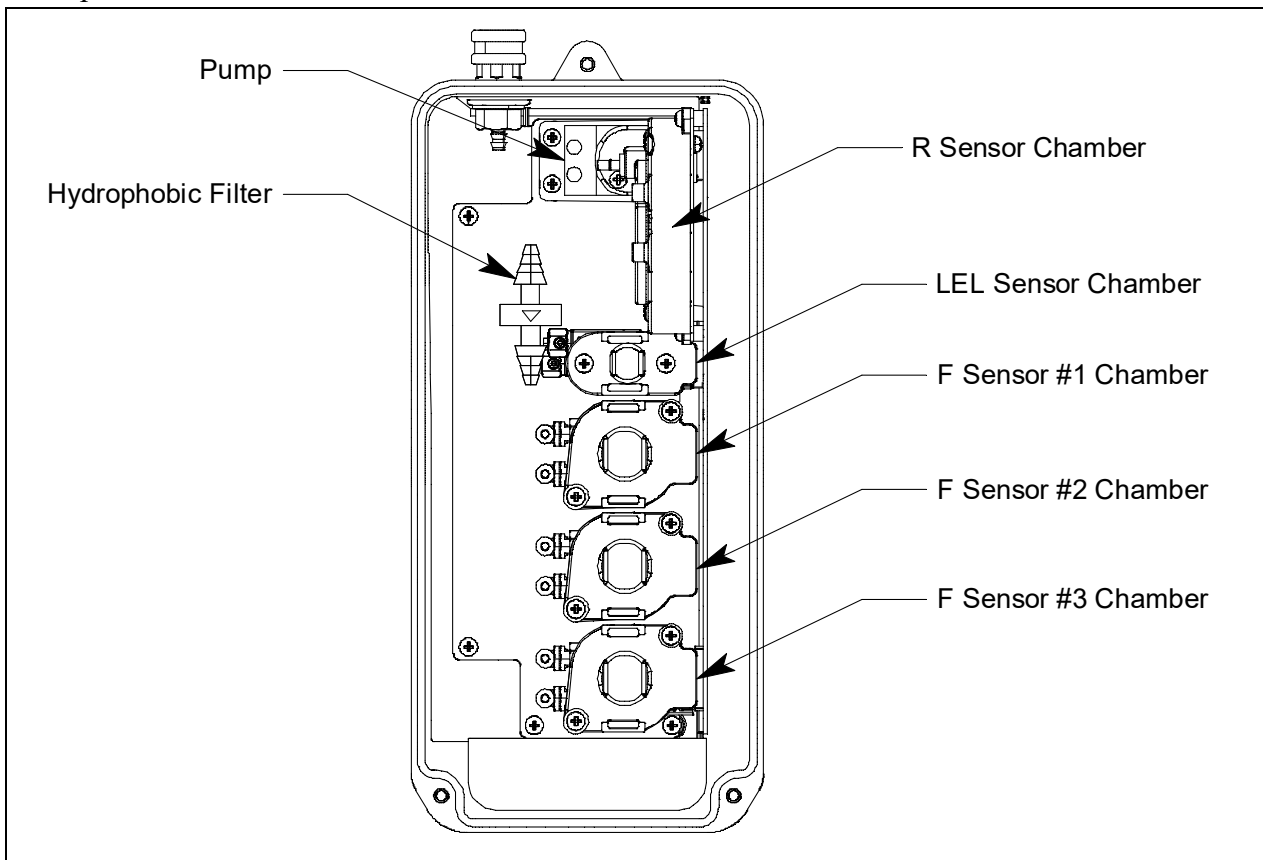

Figure 4: Sensor Flow Blocks

The sensors for the four standard gases (LEL, oxygen, H₂S, and CO) are described in the sections below. F sensors have their own appendices that contain calibration, maintenance, and replacement parts information:

- For PID sensors, see page 191.
- For ESF toxic sensors, see page 212.
- For TC sensors, see page 219.
- For IR CO₂ sensors, see page 226.
- For IR methane sensors, see page 232.
- For IR hydrocarbon sensors, see page 238.

Catalytic Combustible Gas Sensor (LEL Sensor)

The catalytic combustible gas (LEL) sensor detects combustible gas in the % LEL range. It uses a catalytic element for detection. The reaction of gas with oxygen on the catalyst causes a change in the element's resistance, changing the current flowing through it. The current is amplified by the EAGLE 3's circuitry, converted to a measurement of combustible gas concentration, and displayed on the LCD.

The LEL sensor housing includes a sintered metal flame arrestor on one end that allows gas to diffuse into the sensor. On the other end, five pins extend from the sensor. The pins plug into an adapter PCB on the bottom of the sensor retainer. The adapter PCB has pins that fit in a connector on the main PCB (see Figure 5 on page 22). The LEL sensor chamber is mounted to the bottom plate of the unit.

R Sensors (O₂, CO, and H₂S Sensors)

CAUTION: *Due to the way they operate, electrochemical type sensors may exhibit positive or negative sensitivity to gases other than the detection target gas. In environments where interference gases are present, the reading may differ from the actual concentration of the detection target gas present. Note that false alarms or M OVER alarms may be triggered, especially at high concentrations.*

The O₂, CO, and H₂S sensors are installed in a flow block that is, in turn, installed to the main PCB. These sensors are electrochemical cells that consist of three precious metal electrodes in a dilute acid electrolyte. A gas permeable membrane covers the sensor face and allows gas to diffuse into the electrolyte. The gas reacts in the sensor and produces a proportional current (exponential for the O₂ sensor and linearly for the CO and H₂S sensors) to the concentration of the target gas. The EAGLE 3's circuitry amplifies the current, converts the current to a gas concentration, and displays the concentration on the LCD.

There are 2 different types of CO sensor available:

- CO (ESR-A13P-CO): A single electrochemical cell that detects CO
- H₂-compensated CO (ESR-A1CP-CO-H): A single electrochemical cell that detects CO. This sensor does not respond to or responds minimally to hydrogen (displays **H2 RICH** once H₂ concentration exceeds 2000 ppm)

Filters

CO Sensor Charcoal Filter (Black)

A black charcoal filter is placed into a recess in the filter gasket over the CO sensor. The charcoal filter disk scrubs H₂S and certain hydrocarbons out of the sample to avoid false CO readings. If false or elevated CO readings are noticed, especially in the presence of H₂S, change the charcoal filter.

H₂S Sensors Humidity Filter (White)

A white humidity filter is placed into a recess in the filter gasket over the H₂S sensor (if an H₂S sensor is installed). The filter absorbs humidity in the sampling environment to prevent unstable readings around 0 ppm. “H₂S” is printed on the side of the filter.

For users with a 1 ppm H₂S alarm setpoint, the filter should be replaced every 6 months, if you notice a drift on the zero reading, or if the filter appears dirty (whichever is sooner). For users with a 2 ppm or higher H₂S alarm setpoint, the filter does not necessarily ever need to be replaced.

Printed Circuit Boards (PCBs)

The EAGLE 3's PCBs analyze, record, control, store, and display the information collected. The R sensor board is mounted to the main PCB which is installed in the bottom case. The display PCB is installed in the top case and is not involved in any user-performed maintenance. Separate connectors are installed directly to the main PCB to connect to the pump, LEL, PID, IR, and TC sensors via sensor adapter PCBs in the flow blocks.

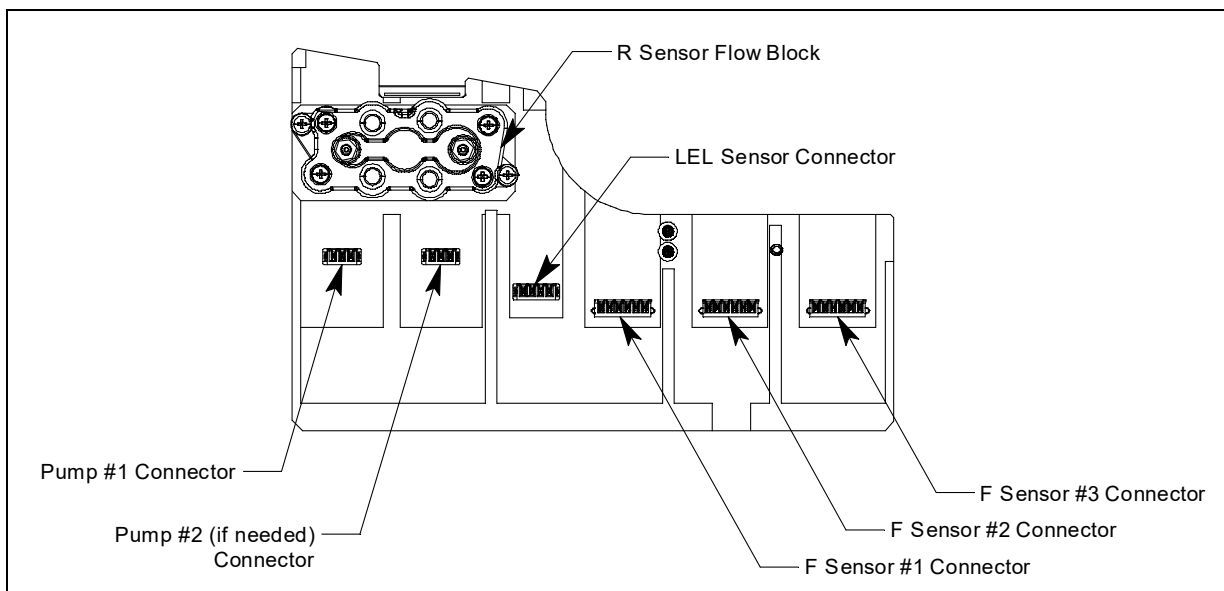

Figure 5: Main PCB

The main PCB is located on the right side of the bottom case. It slides into grooves in the bottom case. Connectors for the sensors, pump, display PCB, charger/communication PCB, and battery pack are located on the main PCB.

Communication/Charging Port

The EAGLE 3's charging and communication port is on the right side of the bottom case. The AC charger and optional USB cable have compatible sliding connectors that fit securely into the port to allow for charging and optional data downloading.

Flow System

The EAGLE 3 flow system consists of the inlet fitting, hydrophobic filter, pump, internal tubing, pressure sensor, sensor chambers, and exhaust fitting.

Inlet Fitting

When viewed from the front, the inlet fitting is on the right side of the bottom case. It is a nickel-plated brass quick connect fitting. It mates with either the sample hose or with the hydrophobic probe.

Hydrophobic Filter

The hydrophobic filter is located in the bottom case next to the pump and LEL sensor. Normally, the hydrophobic probe accessory (see page 25) will prevent water and particulate matter from entering the flow system. However, if the probe is not used, the hydrophobic filter will stop water and particulates from penetrating further into the flow system. If the filter becomes dirty or water logged, replace it (see page 101).

Pump

A diaphragm pump is located at the front of the bottom case and draws the sample to the sensors. It can draw sample from as far as 125 feet from the EAGLE 3.

CAUTION: *Sample hose lengths of more than 125 feet are not recommended for the EAGLE 3 because of flow rate reduction and increased response time. Consult with RKI Instruments, Inc. for sample hose lengths longer than 125 feet.*

Internal Tubing

The flow system includes polyurethane tubing to route the sample between the various components of the flow system. The internal sample tubing is not user-serviceable.

Pressure Switch

The pressure switch is installed on the main PCB. It senses the EAGLE 3's flowrate by monitoring the pressure at one point in the flow system. When the flowrate becomes too low for safe operation of the EAGLE 3, the instrument indicates a low flow alarm.

Sensor Chambers

The O₂, CO, and H₂S sensors are installed in an R-sensor flow block that is mounted to the main PCB. The LEL sensor and any installed IR, PID, TC, or super-toxic sensors are installed in individual F-sensor flow blocks that connect to the main PCB.

Exhaust Fitting

The exhaust fitting is located below the inlet fitting. It routes the gas sample out of the EAGLE 3. It includes a female 10-32 thread that can be used for the installation of a hose barb or other type of fitting that has a male 10-32 thread so that the exhaust can be routed to a particular location with flexible tubing if desired.

Battery Pack

A battery pack is installed at the back of the bottom case. A fully-charged battery pack can power the EAGLE 3 for 30 hours of non-alarm operation. The current battery voltage is viewable in Display Mode (see page 59).

When the EAGLE 3 detects low battery voltage, a low battery warning is activated. When battery voltage is too low for operation, the EAGLE 3 sounds a dead battery alarm.

The battery pack can be recharged by using the EAGLE 3 charger (see page 99).

NOTE: Use of the battery pack or charger not specified by RKI Instruments, Inc. will void the CSA classification and may void the warranty.

WARNING: *To prevent ignition of a hazardous atmosphere, batteries must only be charged in an area known to be nonhazardous.*

Standard Accessories

Standard accessories include the shoulder strap, the sample hose, the hydrophobic probe, and the AC charger.

Shoulder Strap

A comfortable elastic shoulder strap clips to the EAGLE 3 at the front and rear of the top case. It clips to stainless steel rings that are installed in features on the top case. It can be removed from the EAGLE 3 by opening the clip at each end of the strap and removing it from both strap rings.

Hose and Probe

A 5-foot polyurethane sample hose and a 10-inch hydrophobic probe are included as standard. The hose has a male quick connect fitting on one end and a female quick connect fitting on the other end. The probe has a male quick connect fitting. Normally, the male end of sample hose is installed in the EAGLE 3 inlet fitting, and the probe is installed in the female end of the hose.

However, if the sample hose is not needed for monitoring a particular area, the probe may be installed directly to the inlet fitting. Sample hose lengths are available from 5 feet (standard length) to 125 feet (see “Chapter 8: General Parts List” on page 109).

NOTE: A Teflon-lined hose is provided with all units that contain a PID sensor and/or ESF sensor. This hose must be used when operating a PID EAGLE 3 (see page 191). The maximum length for Teflon-lined hoses is 20 feet.

CAUTION: *Sample hose lengths of more than 125 feet are not recommended for the EAGLE 3 because of flow rate reduction and increased response time. Consult with RKI Instruments, Inc. for hose lengths longer than 125 feet.*

The probe includes a replaceable hydrophobic filter disk that prevents particulates and water from entering the EAGLE 3’s flow system. See page 100 for instructions to replace the hydrophobic filter disk.

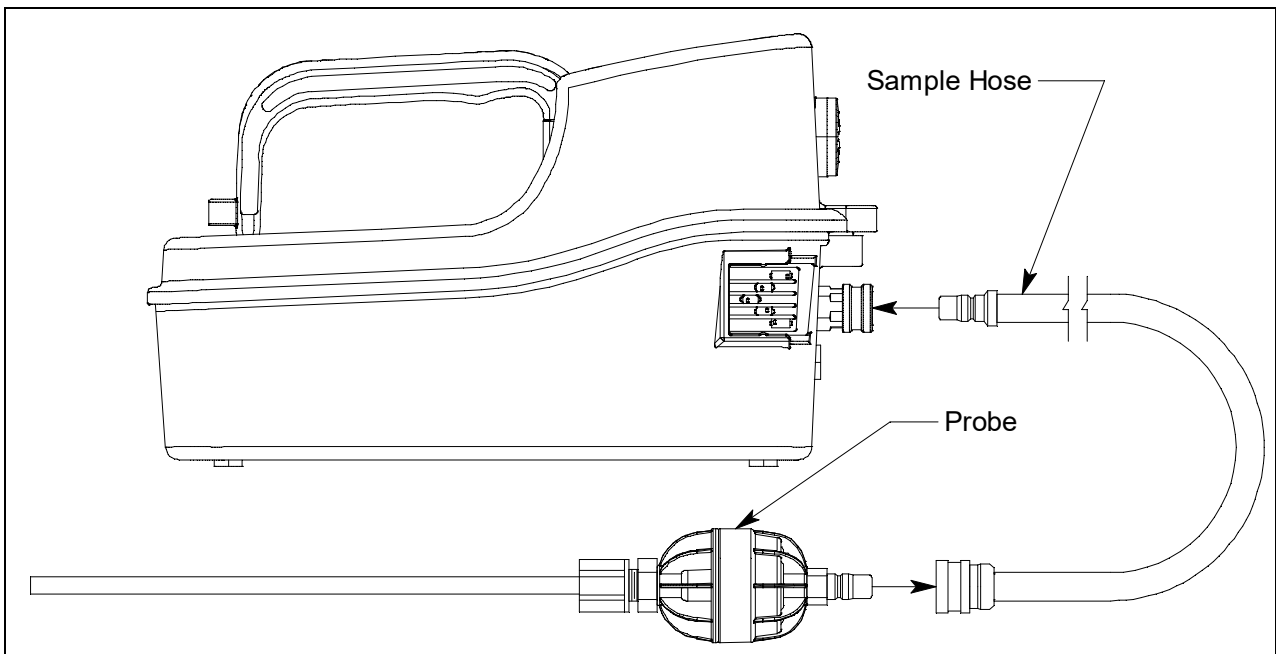

Figure 6: Sample Hose and Hydrophobic Probe

AC Charger

A 3-foot AC charger is included as a standard accessory. The charger has a custom fitting on the end that mates with the communication/charger connection port on the side of the EAGLE 3. The other end of the charger has an adapter for an AC outlet.

CAUTION: Do not short-circuit the connection terminals with metal objects.



Figure 7: Charger

Optional Accessories

Several optional accessories are available for the EAGLE 3, including various special probes, dilution fittings, and a data communication cable. Detailed instructions regarding the use of these and other available accessories are included in other parts of this manual. For information on data logging accessories, see page 58.

Optional Probes

The following probes are each designed for specific applications and are available for the EAGLE 3. See page 109 for probe ordering information.

CAUTION: Please consult with RKI Instruments when selecting optional probes for sensors detecting corrosive or adsorptive gases, especially for gases detected by ESF sensors or PID sensors. There should be restrictions on length and material of probes due to adsorption issues.

Super-toxic gases probe

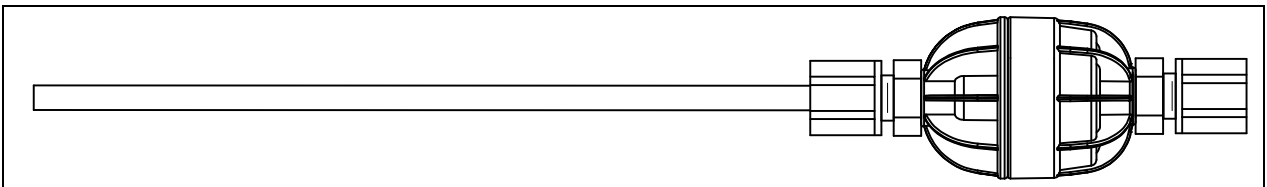

Figure 8: Super-Toxic Gases Probe

This 10-inch probe is designed for applications where one or multiple super-toxic gases are present. The probe body only contains a hydrophobic filter.

30-inch aluminum probe

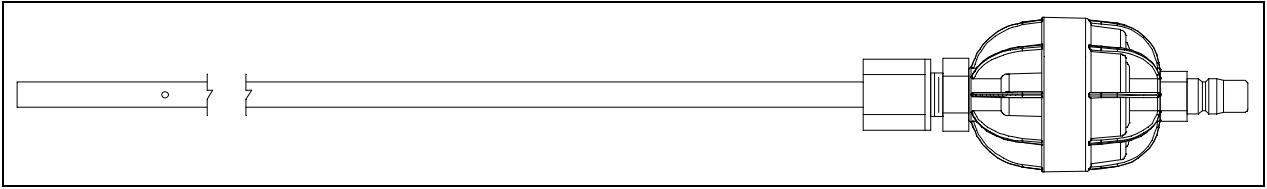

Figure 9: 30-Inch Aluminum Probe

This probe is designed for use where it is necessary to put the probe tip in areas that are out of reach with the standard probe. A small breather hole near the end of the probe tube prevents interruption of sampling and emits a low flow alarm if the probe tip is blocked.

30-inch stainless steel probe

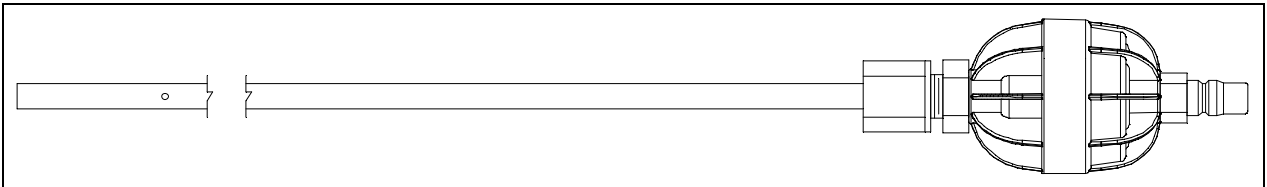

Figure 10: 30-Inch Stainless Steel Probe

This probe is physically the same as the 30-inch aluminum probe and is intended for use where a high level of corrosion resistance is required in the long probe tube.

4-foot stainless steel probe

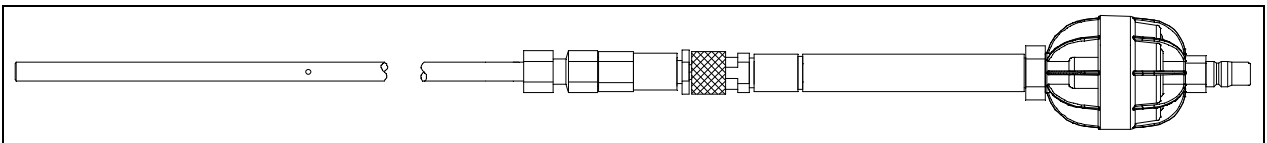

Figure 11: 4-Foot Stainless Steel Probe

This probe is designed for use where it is necessary to put the probe tip in areas that are out of reach for even the 30-inch probes. Because the length of the probe tube requires a high degree of rigidity, a stainless steel probe tube is used. A small breather hole near the end of the probe tube prevents interruption of sampling and emits a low flow alarm if the probe tip is blocked.

Barhole probe

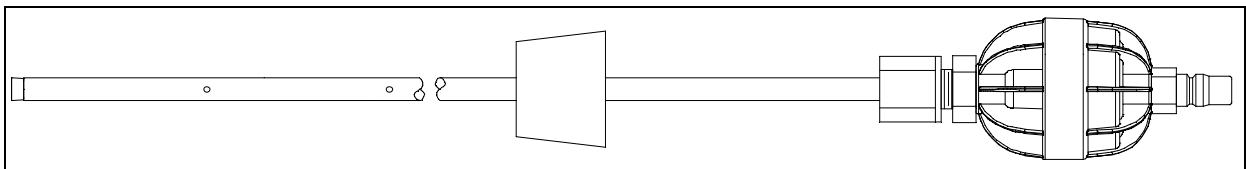

Figure 12: Barhole Probe

This probe is designed specifically for barhole testing. See Appendix J: Using the EAGLE 3 in Bar Hole Mode for an in-depth discussion of using the EAGLE 3 in Bar Hole Mode.

10-inch probe with dust filter

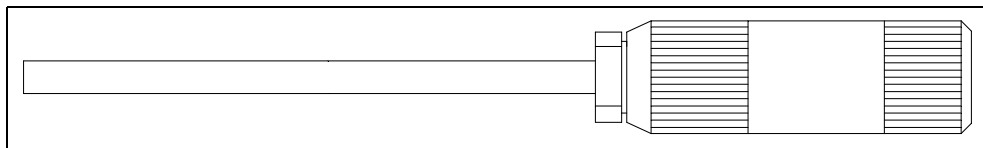

Figure 13: 10-Inch Probe with Dust Filter

This probe is designed for use where drawing water or moisture into the EAGLE 3 is not a concern. Instead of a hydrophobic filter, a cotton dust filter is used.

32-inch telescoping probe with dust filter

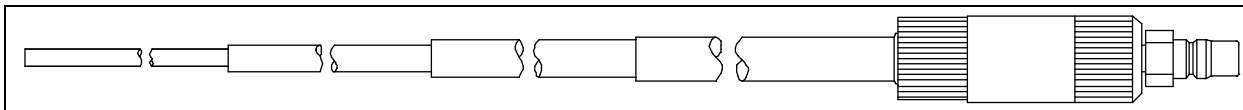

Figure 14: 32-Inch Telescoping Probe with Dust Filter

This probe is designed for use where it is necessary to put the probe tip in areas not accessible with the 10-inch probe with dust filter and applications where the probe tube must be collapsible for storage.

7-foot telescoping probe with dust filter

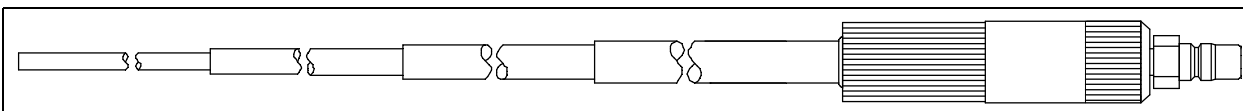

Figure 15: 7-Foot Telescoping Probe with Dust Filter

This probe is designed for use where it is necessary to put the probe tip in areas not accessible with the 32-inch telescoping probe with dust filter and applications where the probe tube must be collapsible for storage.

External Dilution Fittings

The two external dilution fittings available for the EAGLE 3 are a 1:1 dilution fitting and a 3:1 dilution fitting. They are designed to mate with the inlet fitting and accept a sample hose or probe. The fittings are made with brass and nickel plated brass and are appropriate for use with the four standard gases. The 1:1 fitting is normally used when it is necessary to introduce air into a sample that has no oxygen or a very low level of oxygen, such as a nitrogen-purged sample. Both the 1:1 and 3:1 fittings can also be used when one of the target gas levels in the sample area will likely be present in a concentration above the detection range for that gas. Since the fittings partially consist of unplated brass, they are not appropriate for detection of elevated levels of H₂S or easily absorbed gases, such as Cl₂ or SO₂.

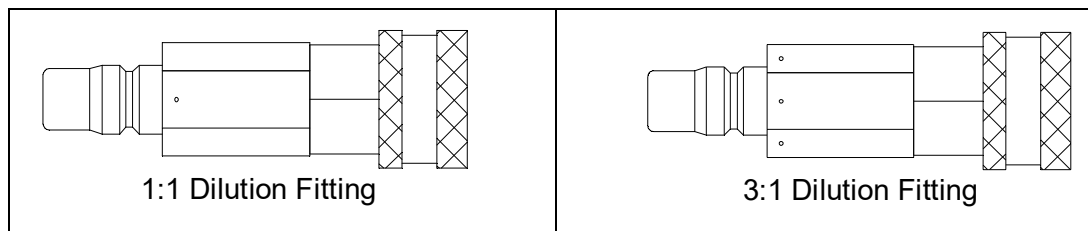

Figure 16: 1:1 and 3:1 Dilution Fittings

Data/Communication USB Cable

The EAGLE 3 USB cable can be ordered for connecting the instrument to a computer when using the Data Logger Program.

NOTE: The data cable should not be used to charge the instrument. Its intended function is to communicate with the Data Logger Program.

Chapter 3: Operation

This chapter explains how to use the EAGLE 3 to perform confined space entry monitoring or general area monitoring in Normal Mode. Special versions of the EAGLE 3 can also operate in Leak Check Mode and Bar Hole Mode. See page 248 and page 257 for operating instructions for Bar Hole and Leak Check Mode, respectively.

Start Up

This section explains how to start up the EAGLE 3, prepare it for operation, and turn it off.

WARNING: *A thin protective film covers the display to prevent scratches during shipping. Remove this film before use. Leaving the film installed voids the intrinsically safe certification.*

NOTE: The screens illustrated in this chapter are for a 4-gas/NH₃ unit.

Turning On the EAGLE 3

The EAGLE 3 may be used with a sample hose or with the probe installed directly to the inlet fitting. Determine which configuration works best for the situation before starting up the EAGLE 3.

NOTE: When turning on the product for the first time or if the battery level is low, be sure to charge the battery using the dedicated AC charger.

1. Connect the sample hose or probe to the EAGLE 3's quick connect inlet fitting.
2. If a sample hose is being used, connect the probe to the sample hose's quick connect fitting.
3. Press and hold **POWER** for a few seconds. Confirm that the LCD turns on, the LEDs flash, and the buzzer sounds before continuing with operation.
4. Release **POWER** after the instrument beeps once.
5. The LCD displays the RKI Instruments logo for a few seconds.



6. The **Date/Time** screen appears for a few seconds.

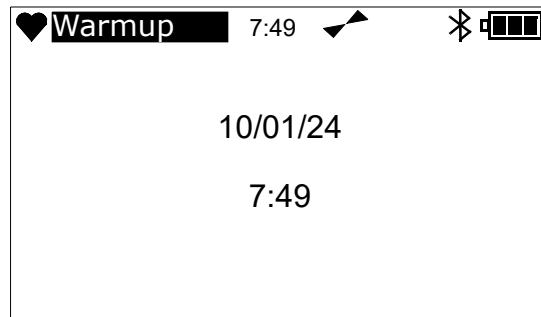

7. The **Battery Voltage** screen appears for a few seconds.

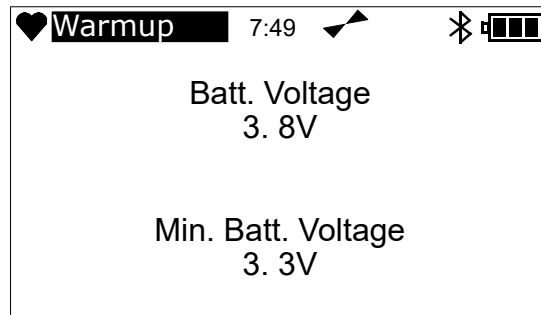

8. If **Lunch Break** is set to **On** (see page 174), the **Resume Measurement?** screen will appear. The LCD displays a 5-second countdown in the lower middle of the screen.

NOTE: By default, this feature is disabled, and the unit will instead display the Calibration Reminder.

- Continue Accumulating: To continue accumulating peak and time-weighted average (TWA) readings from the last time the EAGLE 3 was used, press **AIR** or allow the countdown to reach 0.
 - The unit will resume tracking time in operation from the last time the EAGLE 3 was used. See page 76 for more information. The short-term exposure limit (STEL) reading is reset each time the EAGLE 3 is turned on.

- **Reset Accumulation:** To reset the accumulation of peak and time-weighted average (TWA) readings and time in operation, press **DISPLAY** before the countdown reaches 0.

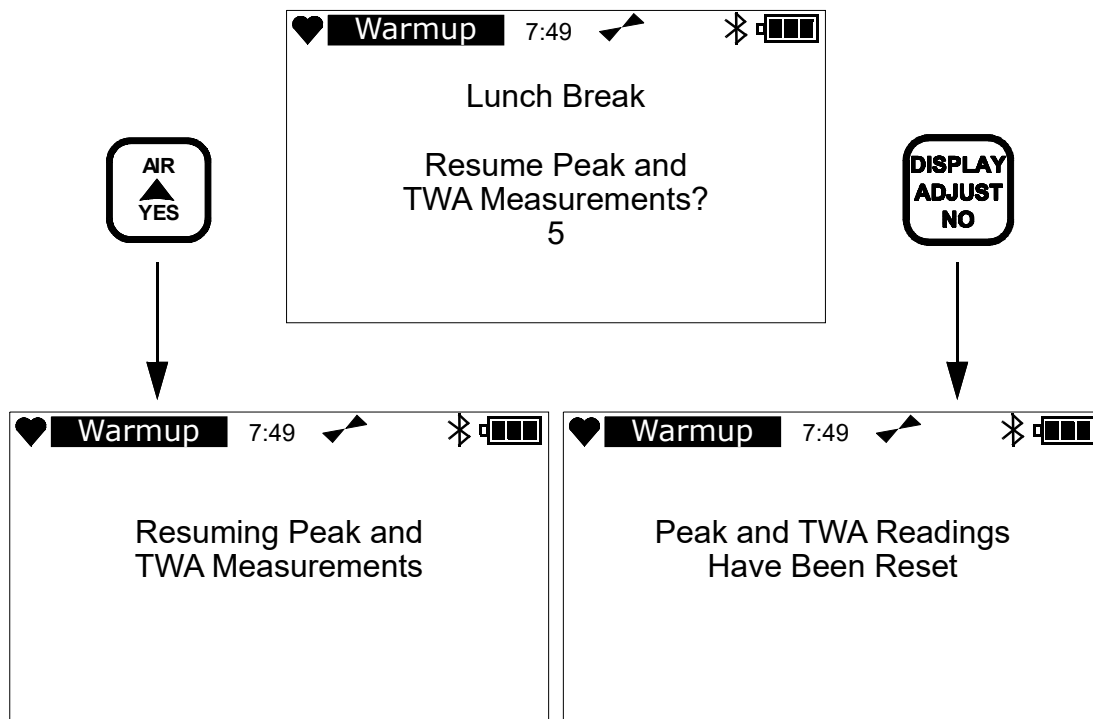

9. By default, the **Cal Reminder** screen will appear. To disable this setting, see page 147 for turning the reminder **On** and **Off**.

If no calibration is due, the EAGLE 3 displays the days remaining until the next calibration date as shown below.

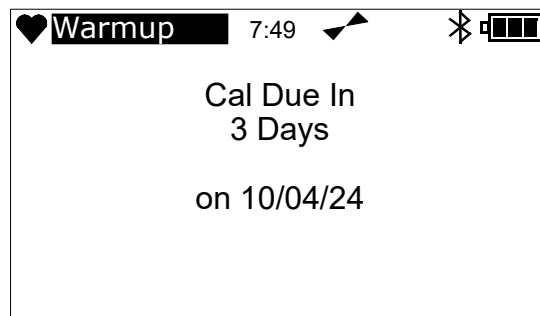

If a calibration is due, the screen appearance depends on the setting of the **Cal Past Due Act** parameter and a calibration may be required. See page 148 for changing this parameter.

- **Calibration Past Due Act: Confirm to Use**

If **Cal Past Due Act** is set to **Confirm**, the instrument can either be calibrated or resume warmup without calibration.

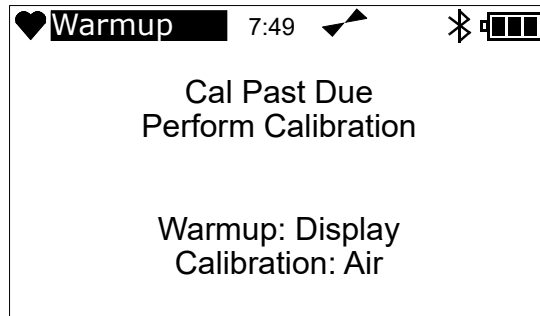

To confirm and resume warmup without performing a calibration, press **DISPLAY**. Proceed to Step 10.

To perform a calibration, press **AIR**.

- a. If **Calibration Password** is set to **On** (factory setting is **Off**), a password screen appears with the number flashing.

Press **AIR** or **RANGE** to change the selected number and press **POWER** to enter each number.

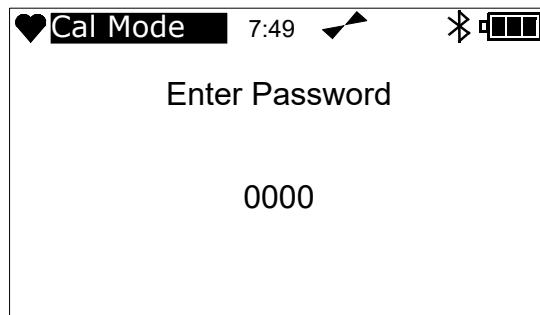

- b. After the password is entered correctly, the instrument enters **Calibration Mode**. Press **AIR** or **RANGE** to scroll to the **Span Cal** menu item. Press **POWER** to select it.

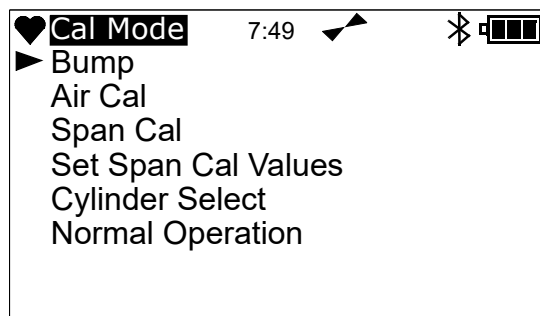

c. The **Span Cal** screen appears. See page 87 for calibration instructions.

♥ Cal Mode 7:49			
CH4 %LEL	O2 %	CO ppm	
50	12.0	50	
H2S ppm	NH3 ppm		
25.0	40.0		
Span Cal		Cylinder A	

- If the calibration is successful, the **Cal Past Due** screen won't appear until the next calibration date. Proceed to Step 10.
- If the calibration is unsuccessful, the instrument indicates which channels failed. Press **POWER** to acknowledge the failure. The warmup sequence will resume.

• **Calibration Past Due Action: Can't Use**

If **Cal Past Due Act** is set to **Cannot Use**, the instrument must be calibrated before it can proceed with warmup.

♥ Warmup 7:49			
Cal Past Due			
Must Calibrate			
Calibration:Air			

- a. If **Calibration Password** is set to **On** (factory setting is **Off**), a password screen appears. Press **AIR** or **RANGE** to change the selected number and press **POWER** to enter each number.

♥ Cal Mode 7:49			
Enter Password			
0000			

- b. After the password is entered correctly, the instrument enters **Calibration Mode**. Press **AIR** or **RANGE** to scroll to the **Span Cal** menu item. Press **POWER** to select it.

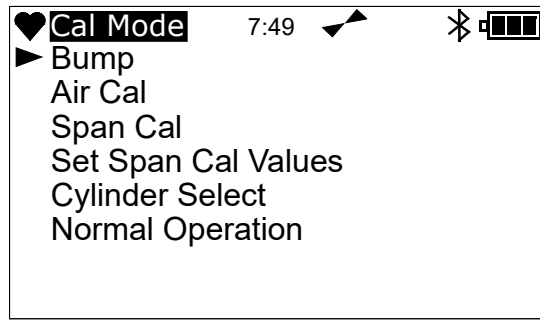

- c. The **Span Cal** screen appears. See page 87 for calibration instructions.

CH4 %LEL		O2 %	CO ppm
50		12.0	50
H2S ppm	NH3 ppm		
25.0	40.0		
Span Cal		Cylinder A	

- If the calibration is successful, the **Cal Past Due** screen won't appear until the next calibration date. Proceed to Step 10.
 - If the calibration is unsuccessful, the instrument indicates which channels failed. Press **POWER** to acknowledge the failure. The instrument cannot be used until a successful calibration is performed.
- **Calibration Past Due Action: None**

If the **Cal Past Due Act** setting is set to **None**, the calibration reminder is displayed for a few seconds before the warmup sequence continues.

If desired, press **AIR** to perform a calibration but is not necessary to acknowledge the calibration indication. The warmup sequence will continue on its own.

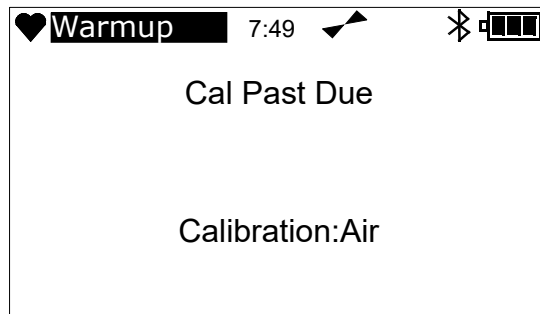

10. If **Bump Reminder** is set to **On** (see page 151), the **Bump Test Reminder** screen will appear.

11. If no bump test is due, the EAGLE 3 displays the days remaining until the next bump test date as shown below.

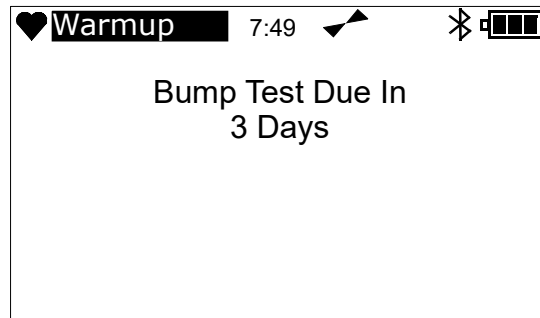

If a bump test is due, the screen appearance depends on the setting of the **Bump Past Due Act** parameter and a bump test may be required. See page 153 for changing this parameter.

- **Bump Test Past Due Action: Confirm to Use**

If **Bump Past Due Act** is set to **Confirm to Use**, the instrument can either be calibrated or resume warmup without calibration.

Press **AIR** to continue without bump testing, or press **POWER** to perform a bump test.

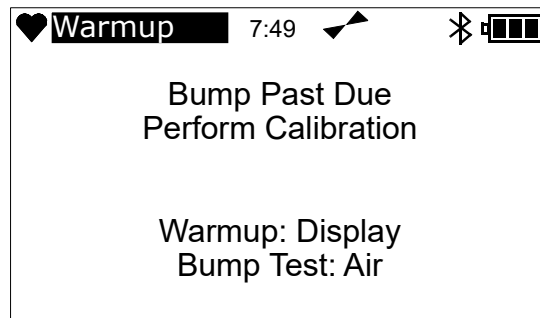

To confirm and resume warmup without performing a bump test, press **DISPLAY**. Proceed to Step 10.

- If the bump test is successful, the **Bump Past Due** screen won't appear until the next calibration date. Proceed to Step 10.
- If the bump test is not successful, the instrument indicates which channels failed. Press **POWER** to acknowledge the failure. The warmup sequence will resume.

- **Bump Test Past Due Action: Cannot Use**

If **Bump Past Due Act** is set to **Cannot Use**, the instrument must be bump tested before it can proceed with warmup.

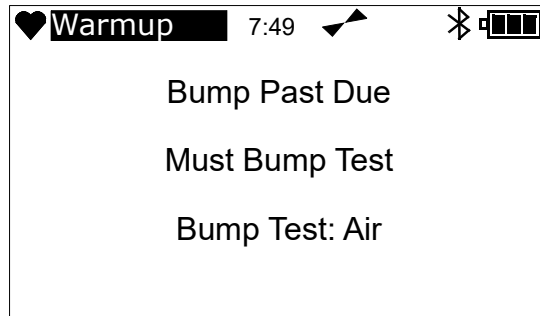

- If **Calibration Password** is set to **On** (factory setting is **Off**), a password screen appears. Press **AIR** or **RANGE** to change the selected number and press **POWER** to enter each number.

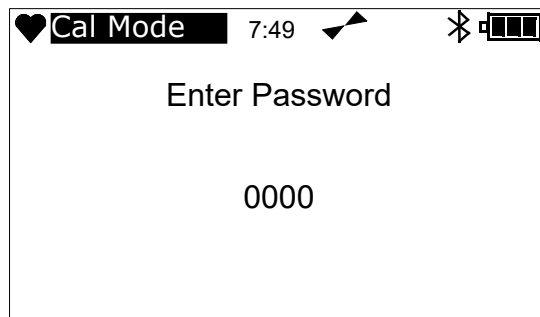

- After the password is entered correctly, the instrument enters **Calibration Mode**. Press **AIR** or **RANGE** to scroll to the **Bump** menu item. Press **POWER** to select it.

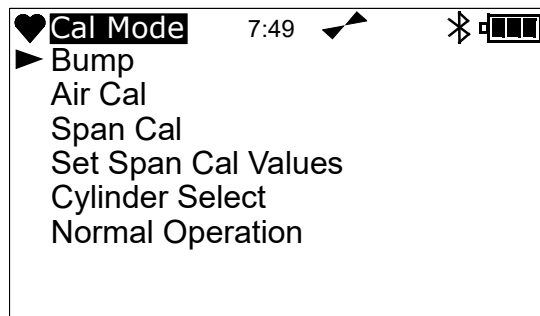

- The **Bump** screen appears. See page 87 for calibration instructions.

Cal Mode					
CH4 %LEL	O2	%	CO	ppm	
50	12.0		50		
H2S ppm	NH3	ppm			
25.0	40.0				
Bump			Cylinder A		

- If the bump test is successful, the **Bump Past Due** screen won't appear until the next calibration date. Proceed to Step 10.
 - If the bump test is unsuccessful, the instrument indicates which channels failed. Press **POWER** to acknowledge the failure. The instrument cannot be used until a successful bump test is performed.
- **Bump Test Past Due Action: None**

If the **Bump Past Due Act** setting is set to **None**, the bump test reminder is displayed for a few seconds before the warmup sequence resumes.

If desired, press **POWER** to perform a bump test but is not necessary to acknowledge the bump test due indication. The warmup sequence will continue on its own.

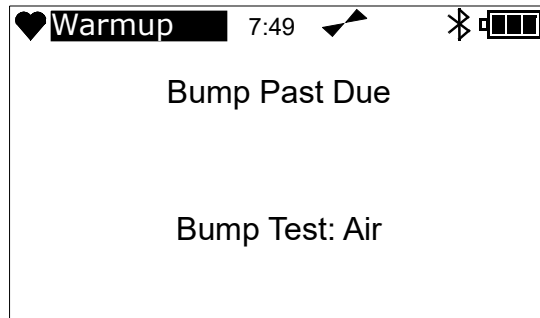

12. The **Gas Names** screen appears for three seconds, indicating which channels are active and their target gases.

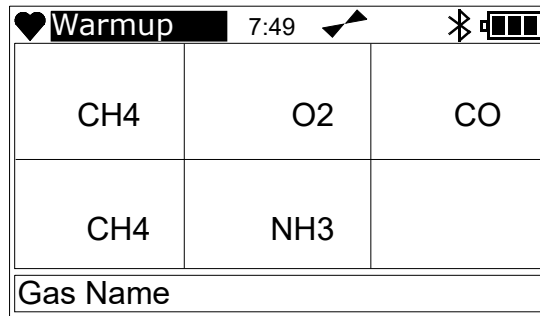

13. The alarm setpoint screens appear in the following sequence: **Full Scale**, **Alarm 1**, **Alarm 2**, **STEL**, and **TWA**. The LCD displays the each screen for 3 seconds. The current **Alarm Latching** setting is displayed on the non-full scale screens.

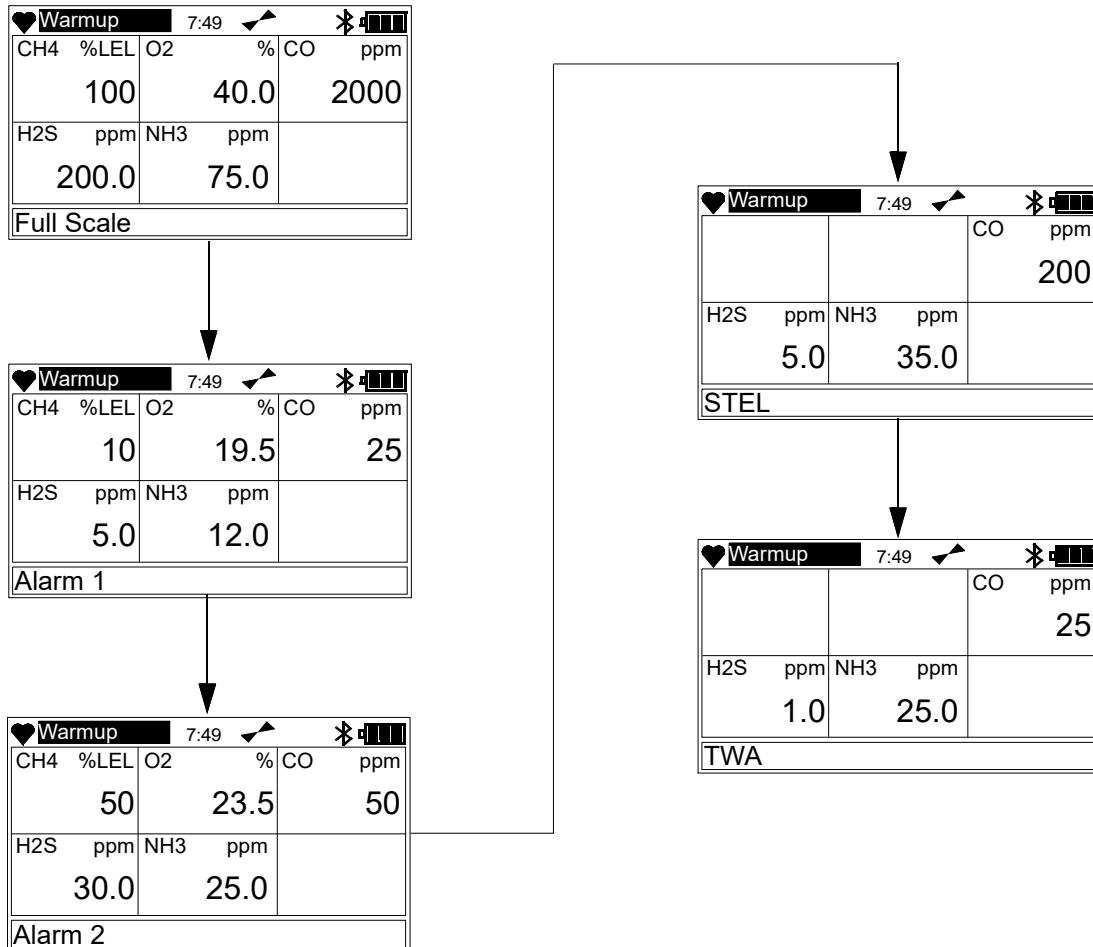

14. If the **User and Station ID** option is set to **On** (see page 138), the **ID Screen** will display the assigned IDs for three seconds.

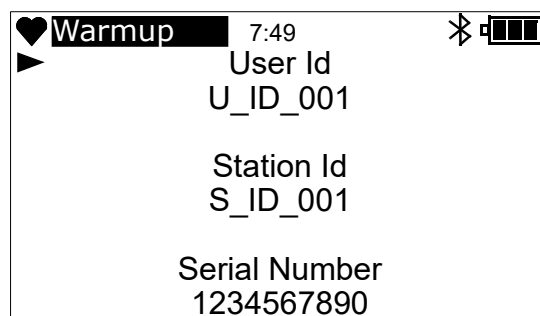

If **User and Station ID** is **Off**, only the instrument's serial number appears.

15. If any sensors are not warmed up by the time the previous sequence ends, the EAGLE 3 continues to display text to indicate sensors are still warming up.

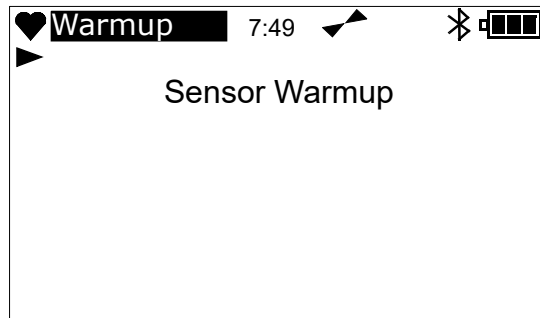

16. If the EAGLE 3 experiences a sensor failure during the warmup sequence, the LCD indicates which sensor failed and the buzzer sounds a pulsing tone twice per second. In the example below, the H₂S sensor has failed.

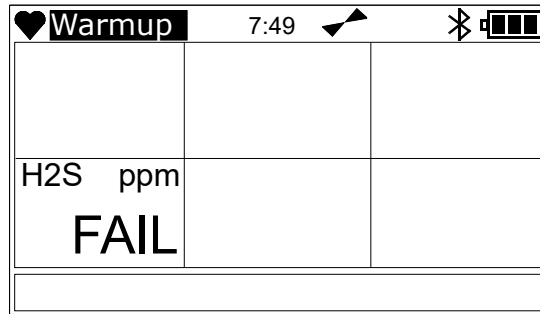

Press **POWER** to acknowledge the failure. “- - -” replaces the failed sensor’s gas reading. Replace the failed sensor as soon as possible (see page 104).

17. If **Auto Zero** is set to **On** (factory setting is **Off**, see page 140), the instrument prompts you to do an auto zero.

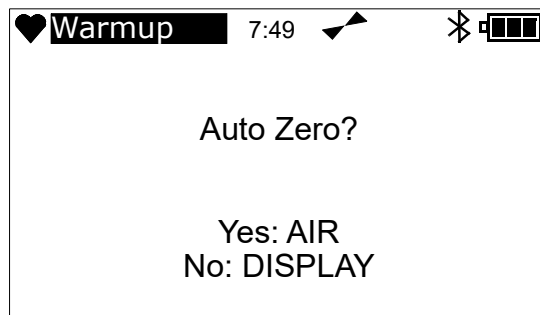

WARNING: *Make sure that the instrument is in a known fresh air environment (an environment free of combustible or toxic gases and of normal oxygen content, 20.9%) before performing an auto zero operation. If you perform an auto zero operation in an area with gases present, the adjustment will not be accurate.*

- a. An auto zero operation sets the combustible gas, H₂S, CO, and super toxic channels to 0 and the O₂ channel to 20.9%.
 - b. If the instrument has a CO₂ sensor installed and **CO2 Air Zero** is set to **On** in Setup Mode, the CO₂ channel gets set to 400 ppm (0.04% volume) during an auto zero. If **CO2 Air Zero** in Setup Mode is set to **Off**, the CO₂ channel is not adjusted during the auto zero. See “Turning CO2 Air Zero On or Off” on page 141.
 - c. You must press POWER to perform an auto zero function. If no key is pressed after 15 seconds, the instrument enters Normal Mode without performing an auto zero.
18. The Normal Mode screen appears, showing the current gas reading for each target gas. See “Normal Mode Operation” on page 43 for descriptions of on-screen icons and features.

♥		7:49		📶		🔊	
CH4 %LEL	O2 %	CO ppm					
0	20.9	0					
H2S ppm	NH3 ppm						
0.0	0.0						

Performing a Demand Zero

Before using the EAGLE 3, perform a demand zero to set the fresh air readings for the target gases. This will set the CH₄, H₂S, CO, and IR combustible, TC, or PID channels to zero and the OXY channel to 20.9%.

If the instrument has a CO₂ sensor installed and the **CO2 Air Zero** setting is set to **On** in Setup Mode, the CO₂ channel gets set to 400 ppm (0.04% volume). If **CO2 Air Zero** in Setup Mode is set to **Off**, the CO₂ channel is not adjusted during the demand zero. See “Turning CO2 Air Zero On or Off” on page 141.

1. Find a fresh-air environment. This is an environment free of toxic or combustible gases and of normal oxygen content (20.9%).
2. Turn on the unit as described in “Turning On the EAGLE 3” on page 30.
3. After the EAGLE 3 finishes its warmup sequence, press and hold **AIR**. The LCD displays a “Hold Air Key” prompt and the buzzer pulses while you hold **AIR**.

- Continue holding **AIR** until the LCD displays a prompt to release it.

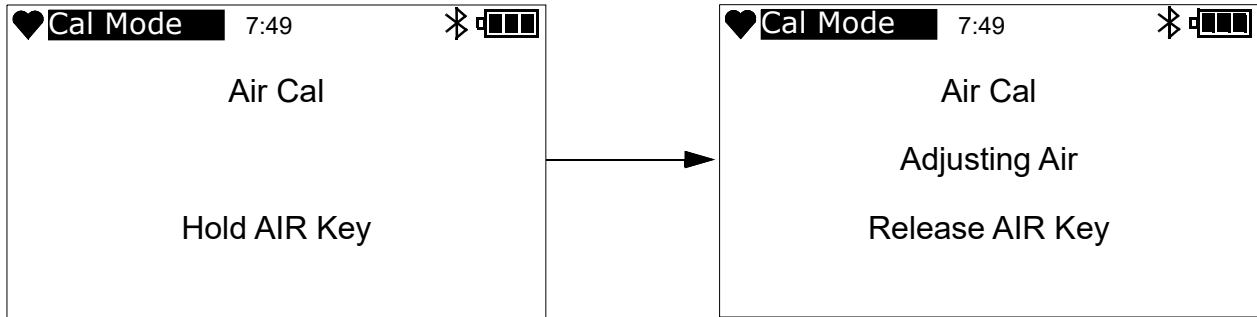

- The EAGLE 3 will set the fresh air reading for all channels. Start up is complete and the unit is now ready for monitoring.

CH4 %LEL		O2 %	CO ppm
0		20.9	0
H2S ppm		NH3 ppm	
0.0		0.0	

Turning Off the EAGLE 3

- Press and hold **POWER**. The LCD displays “Turn Off”.
- The buzzer will pulse for five seconds.
- Release **POWER** when “Goodbye” appears on the LCD. The message will disappear and the internal pump(s) will turn off.

Normal Mode Operation

After completing its warmup sequence, the EAGLE 3 enters Normal Mode. In Normal Mode, the EAGLE 3 continuously monitors the sampled atmosphere and displays the target gas concentrations. The EAGLE 3 is considered to be in Normal Operation if there are no alarm indicators.

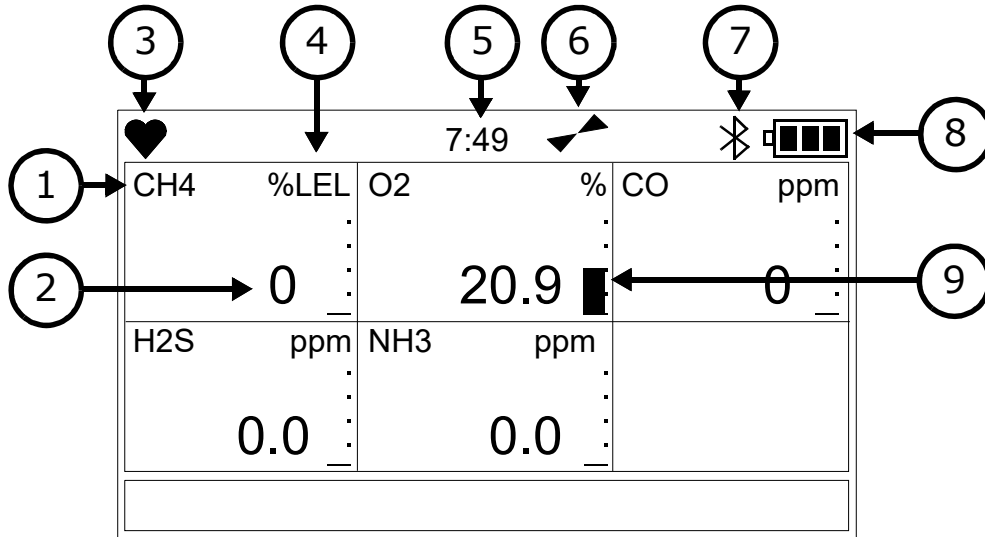

1. Target Gas Name: Each channel's target gas is displayed in the top left corner of each channel's section.
2. Concentration Reading: Each channel reading is displayed in the center of each channel's section.
3. Heart Symbol: The heart symbol in the upper left corner of the LCD indicates the operation status and blinks when normal. A microprocessor error causes the heart symbol to stop flashing or disappear.
4. Unit of Measurement: Each channel's unit of measurement is displayed in the top right corner of each channel's section.
5. Time: Displays the time in a 24-hour format
6. Fan Icon: The fan icon will flash/spin when it is working properly.
7. Bluetooth Icon: The Bluetooth icon flashes when the instrument is trying to pair to a phone. The Bluetooth icon is steadily on when the instrument is paired to a phone. The Bluetooth icon is off when the instrument is not paired and is not trying to pair to a phone.
8. Battery Icon: Displays the battery's remaining charge
9. Peak Bar: If the Peak Bar setting in Display Mode is set to **On**, each channel will display a peak bar corresponding to the current Peak readings saved to the instrument.

10. **Backlight:** In a low-light environment, press either button to turn on the display backlight. See page 144 to set the backlight time.

Confirmation/Non-Compliance Indicator

If the **Beep Select** menu item in Setup Mode is set to anything other than **OFF**, the EAGLE 3 gives periodic indicators to confirm that it's operating or to indicate a non-compliance (see page 170 for instructions).

Monitoring an Area

1. Start up the EAGLE 3 as described on page 30. It is now in Normal Mode.

♥		7:49		▲		✎		🔋	
CH4 %LEL	O2	%	CO	ppm					
0	20.9		0						
H2S ppm	NH3	ppm							
0.0	0.0								

2. Take the EAGLE 3 to the monitoring area.
3. Put the probe tip in the area to be monitored.

NOTE: If the hydrophobic filter become dirty or clogged, replace it. See page 100 for instructions to replace the hydrophobic filter.

4. Wait 10 - 15 seconds and monitor the display for gas readings. Allow any readings to stabilize to determine the gas concentrations present.

NOTE: Response times increase with the length of the sample hose. Long sample hoses will require more time to show a response from the EAGLE 3.

The maximum sample hose length recommended for the EAGLE 3 is 125 feet. Consult with RKI Instruments, Inc. for longer sample hose lengths.

5. If a gas alarm occurs, see page 54 for information on responding to alarms.

Using Optional Sample Hoses

The standard sample hose for the EAGLE 3 is 5 feet long. Optional hoses are available up to 125 feet long. If you are considering using a longer hose, keep in mind that a longer hose will increase the EAGLE 3's response time and the flowrate may decrease close to the low flow alarm point.

CAUTION: *Sample hose lengths of more than 125 feet are not recommended for the EAGLE 3 because of flow rate reduction and increased response time. Consult with RKI Instruments, Inc. for hose lengths longer than 125 feet.*

Table 3 illustrates how response time is affected by the sample hose length.

Table 3: EAGLE 3 Response Time vs. Sample Hose Length

Hose Used	Typical Time to 90% of Response (T90)
Probe Only	12 seconds
Probe & 5 Foot Hose	15 seconds
Probe & 25 Foot Hose	25 seconds
Probe & 50 Foot Hose	35 seconds
Probe & 75 Foot Hose	45 seconds
Probe & 100 Foot Hose	60 seconds
Probe & 125 Foot Hose	75 seconds

Using Exhaust Tubing

The EAGLE 3's exhaust fitting has a female 10-32 thread to allow for the installation of a hose barb fitting with a 10-32 thread to which a flexible exhaust tube can be connected. To utilize this feature, the tubing used must have a minimum internal diameter of 1/8 inch. RKI Instruments, Inc. recommends using flexible polyurethane tubing with a maximum exhaust tube length of 20 feet. Consult with RKI Instruments, Inc. for exhaust tubing lengths longer than 20 feet.

Combustible Gas Detection

When monitoring for combustible gas, the catalytic sensor's target gas calibration, overscale protection, and contaminating gases can all affect the sensor's readings and function.

Response

The catalytic combustible gas sensor responds to any combustible gas. The standard calibrated target gas for the combustible gas channel is methane (CH₄). If the instrument is setup for and calibrated to a different combustible gas, such as hexane or propane, the gas name above the readings displays as "HC".

- **Automatic Conversion**

The EAGLE 3 can automatically display converted target gas readings if the instrument's calibrated target gas is methane or isobutane. See "Combustible Sensor Target Gas Conversion (HC GAS LIST)" on page 50.

- **Manual Conversion**

You can manually calculate a converted target gas reading using the table below if the instrument's calibrated target gas is methane. Table 4 lists the conversion factors for several hydrocarbon gases if the EAGLE 3 is calibrated to methane.

To use this table, multiply the display reading on the combustible gas channel by the factor in the appropriate row to obtain the actual gas concentration. For example, if you are detecting pentane and the display reads 10% LEL for the catalytic combustible channel, you actually have 10% LEL x 1.95 = 19.5% LEL pentane present.

Table 4: Response Factors of Common Hydrocarbons

Target Gas	LEL Factor	PPM Factor	Target Gas	LEL Factor	PPM Factor
Acetone	1.92	0.96	Isopropanol	2.44	0.98
Benzene	2.08	0.50	Methane	1.00	1.00
Butyl Acetate	3.23	0.90	Methanol	1.30	1.56
Butyl Acrylate	1.83	0.55	Methyl Acetate	2.70	1.14
2-Butyl Alcohol	2.00	0.68	Methyl Acrylate	1.79	0.86
1-Butyl Alcohol	2.38	0.67	Methyl Ethyl Ketone	2.22	0.80
Cyclohexane	2.00	0.52	Methyl Isobutyl Ketone	2.56	0.62
Cumene	2.56	0.46	Mixed Xylenes	2.38	0.48
Ethylene Dichloride	2.63	3.26	Nonane	3.03	0.42
Ethyl Alcohol	1.82	1.20	Pentane	2.08	0.46
Ethyl Chloride	2.04	1.47	Propane	1.75	0.70
Ethyl Acrylate	2.63	0.74	Styrene	2.94	0.65
Hexane	2.33	0.51	Toluene	2.04	0.49
Hydrogen	1.09	0.87	Vinyl Acetate Monomer	1.75	0.91
Isobutane	1.67	0.60			

Overscale Protection

The EAGLE 3 protects the combustible gas sensor by temporarily turning off the sensor power if levels exceeding 100% LEL are detected. Nevertheless, combustible gas concentrations above 100% LEL can still affect the zero level or calibration of the combustible gas sensor.

***CAUTION:** Do not expose the catalytic combustible sensor to high concentrations of combustible gas such as that from a butane lighter. Exposure to high concentrations of combustible gas may adversely affect the performance of the sensor.*

***CAUTION:** Any rapid increase in the combustible gas reading on the catalytic combustible channel followed by a declining or erratic reading may indicate a gas concentration above the LEL which may be hazardous.*

Damaging Gases

Some gases such as silicone vapors, chlorinated hydrocarbons, and sulfur compounds can contaminate the sensor's detection elements. This causes sensor damage and/or a reduced response to combustible gas. Make every effort to avoid these gases.

Low Flow Alarm (H₂ Selected)

If hydrogen is selected either in the **Configure Gases** menu in Setup Mode or the **Relative Response** menu in Display Mode, the low flow alarm is disabled. The alarm is turned off because hydrogen cannot form the pressure necessary to trigger the pressure switch.

Monitoring Combustible Gas in the PPM or %VOL Range

If the **Catalytic Units** menu item in Setup Mode is set to **Change OK**, the standard factory setting, then the catalytic combustible channel's units can be changed by pressing and releasing **RANGE**.

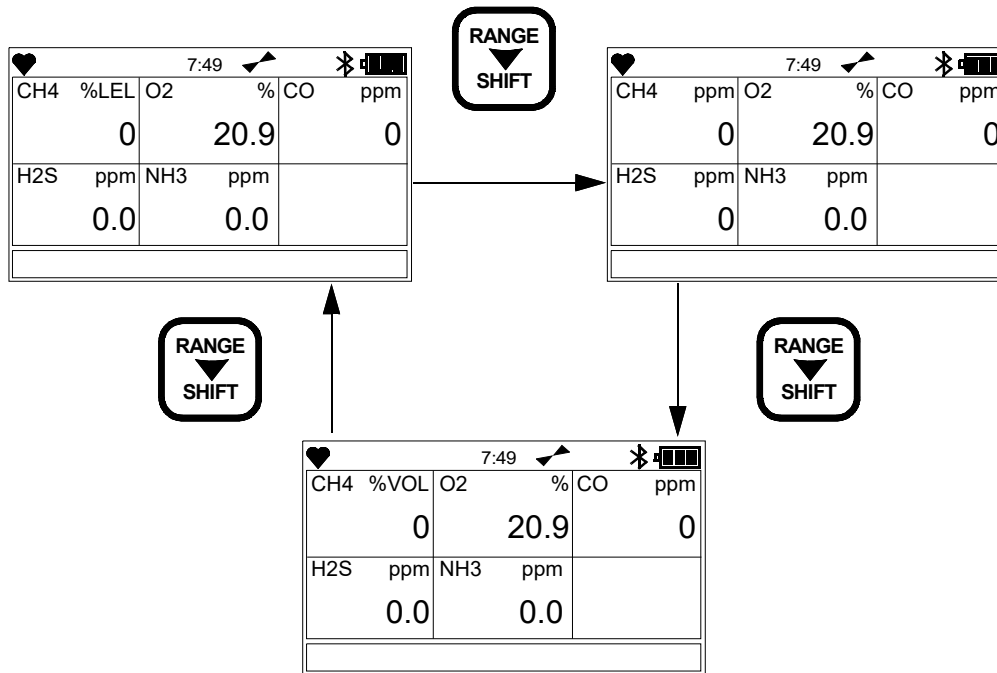

See page 125 for instructions to set this Setup Mode Menu item.

The detection range of the combustible catalytic channel when set for ppm or % volume will correspond to 0 - 100% LEL for the configured gas. For example, the LEL for methane (CH₄) is 5% volume, or 50,000 ppm. So if the catalytic combustible channel is displayed in terms of % volume, then the full scale is 5.00%, and if it is displayed in terms of ppm, then the full scale is 50,000 ppm.

Monitoring Combustible Gas in the PPM Range

• **Stabilization Period**

Because of the EAGLE 3's high sensitivity in the lower part of the ppm range, the catalytic combustible sensor needs more time than the instrument's warm-up period to stabilize after the EAGLE 3 is turned on if it is used for ppm level detection.

• **PPM Increments**

The reading increments in the ppm range are smallest in the lower part of the range and increase as the reading increases:

- 5 ppm increments from 0 ppm to 200 ppm
- 10 ppm increments from 200 ppm to 1,000 ppm
- 50 ppm increments from 1,000 ppm to 10,000 ppm
- 250 ppm increments from 10,000 ppm to 50,000 ppm

- **User-Defined Ratios**

If the catalytic combustible channel is configured for a user-defined gas in Setup Mode (see “Configuring the Gases (Configure Gases)” on page 123), then the gas’ ppm ratio must be considered.

For example, if the ppm ratio of a user-defined gas is set higher than 50,000 ppm, then when the display units are set as ppm the reading will not go above 50,000 ppm (equivalent to 33% LEL and 5% volume).

If the gas reading is higher than 50,000 ppm, the ppm unit reading will indicate 50,000 ppm and also indicate an overscale condition. The % LEL and % volume unit readings will still increase up to 100% LEL and 15% volume respectively (equivalent to 150,000 ppm).

- **Humidity**

The catalytic combustible sensor is slightly affected by humidity. This is not apparent when the EAGLE 3 is used for % LEL or % volume detection, but because of the high sensitivity in the ppm range, significant humidity changes can affect the ppm reading, especially in the lower part of the range. Take care to allow the unit to acclimate to a new environment for about a minute and perform a demand zero in a fresh air location when you move between areas of different humidity.

CAUTION: *If the catalytic combustible channel is being calibrated with a gas concentration of 1000 ppm or lower, a 24 inch humidifier must be used for accurate calibration. See page 79 for more explanation and instructions for calibration.*

To monitor for combustible gas in the ppm range:

1. Start up the EAGLE 3 as described on page 30.
2. After warmup, allow the EAGLE 3 to run for 3 - 5 minutes in Normal Mode. This allows the catalytic combustible sensor to stabilize sufficiently for ppm monitoring.

NOTE: This extra stabilization period is not necessary for monitoring in %LEL or %volume ranges.

3. Press **RANGE** until the catalytic combustible channel’s units are set to ppm.
4. Perform a demand zero as described on page 41.
5. Proceed to monitor for gas as described on page 44.

Oxygen-Enriched Atmospheres

The EAGLE 3 is not intended for use in oxygen-enriched atmospheres.

WARNING: *Do not use the EAGLE 3 in an environment with an oxygen concentration is above 21%.*

H₂-Compensated CO Detection

- EAGLE 3 displays CO readings.
- H₂ reading is not displayed but “H₂ RICH” appears once the H₂ concentration rises above 2000 ppm.

NOTE: The H₂-compensated CO sensor may not effectively compensate for higher levels of H₂ if exposed to temperatures above 40°C for longer than 15 minutes. Under these conditions, it can appear to the instrument that the H₂ concentration has exceeded 2000 ppm, the max concentration that can be compensated for, resulting in a CO reading higher than the actual CO level.

Interference Information

Although the EAGLE 3 can support up to two ESF sensors, many combinations are impractical for various reasons including sensor cross sensitivity to other gases.

The table below indicates some of the gases that will cause an increased gas reading for specific ESF sensors. For example, if you are attempting to detect HCN but H₂ is also present, the instrument’s HCN reading will be higher than the environment’s actual HCN level.

Table 5: Positive Interference

Sensor	Affected By
Chlorine (Cl ₂)	<ul style="list-style-type: none">• HCl• SO₂
Hydrogen Cyanide (HCN)	<ul style="list-style-type: none">• H₂• SO₂
Phosphine (PH ₃)	<ul style="list-style-type: none">• H₂S• SO₂
Sulfur Dioxide (SO ₂)	<ul style="list-style-type: none">• H₂

Table 6 indicates some of the gases that will cause a negative response and a decreased reading for specific ESF sensors. For example, if you are attempting to detect SO₂ but NO₂ is also present, the instrument’s SO₂ reading will be lower than the environment’s actual SO₂ level.

Table 6: Negative Interference

Sensor	Affected By
Ammonia (NH ₃)	<ul style="list-style-type: none"> • HCl • NO₂
Chlorine (Cl ₂)	<ul style="list-style-type: none"> • H₂S • SO₂
Chlorine Trifluoride (ClF ₃)	<ul style="list-style-type: none"> • H₂S • SO₂
Fluoride (F ₂)	<ul style="list-style-type: none"> • H₂S • SO₂
Hydrogen Cyanide (HCN)	<ul style="list-style-type: none"> • NO₂
Hydrogen Fluoride (HF)	<ul style="list-style-type: none"> • H₂S • SO₂
Nitrogen Dioxide (NO ₂)	<ul style="list-style-type: none"> • CO • SO₂
Ozone (O ₃)	<ul style="list-style-type: none"> • H₂S • SO₂
Phosphine (PH ₃)	<ul style="list-style-type: none"> • NO₂
Sulfur Dioxide (SO ₂)	<ul style="list-style-type: none"> • NO₂

Sensor Poisoning Information

Certain gases will permanently change (usually decrease) the performance of a sensor.

Refer to the following table that shows which gases affect which sensors.

Gas	Target Gases/Ranges of Affected Sensors
Hydrogen Sulfide (H ₂ S)	• Cl ₂ , O ₃ , NO ₂ , PH ₃ , SiH ₄ , Si ₂ H ₆ , SO ₂ (0-6 ppm), GeH ₄ , F ₂ , HF, CLF ₃
Sulfur Dioxide (SO ₂)	• Cl ₂ , O ₃ , F ₂ , HF, CLF ₃
C ₂ H ₂	• HCl, SO ₂ (both ranges), NO ₂ , PH ₃ , SiH ₄ , Si ₂ H ₆ , GeH ₄ , NO, HBr
Hydrogen (H ₂)	• HCL and SO ₂ full scales, NO ₂ , PH ₃ , SiH ₄ , Si ₂ H ₆ , GeH ₄ , NO, HBr

CO₂ Detection

- A background level of CO₂ exists in fresh air. Table 7 below indicates a typical gas reading in fresh air.

Table 7: Carbon Dioxide Fresh Air Readings

Sensor Range	Approximate Fresh Air Reading
0 - 10.00% vol./ 0 - 20.00% vol.	0.04% vol.
0 - 10,000 ppm	400 ppm

- Performing a demand zero, an auto zero, or an AIR CAL will either set the CO₂ channel to 400 ppm (0.04% volume) or exclude the CO₂ channel based on the setting of the **CO₂ Air Zero** parameter in **Setup Mode** parameter (see page 141).

Alarms

This section covers alarm types and their indicators while in Normal Mode. It also describes how to reset the EAGLE 3 after an alarm has occurred and how to respond to an alarm condition.

NOTE: False alarms may be caused by radio frequency (RF) or electromagnetic (EMI) interference. Keep the EAGLE 3 away from RF and EMI sources such as radio transmitters and large motors.

Alarm Indicators

When any alarm condition or failure occurs, the EAGLE 3 buzzer sounds an alarm and the LEDs flash. If the EAGLE 3 is operating in Stealth Mode, the buzzer does not sound (see page 173).

The EAGLE 3 will sound an alarm and flash the LED arrays when one of the target gas concentrations rises above the Low Alarm level or falls below a Low Alarm level for O₂.

The EAGLE 3 also sounds an alarm and flashes the LED arrays when one of the target gas concentrations rises above the High Alarm level and when the STEL and TWA alarm levels are reached for CO, H₂S, or other toxic gases.

NOTE: If an alarm condition occurs while in Display Mode, the EAGLE 3's LCD immediately displays the alarm screen instead.

The following table summarizes the types of alarms produced by the EAGLE 3 and their indicators.

Table 8: Alarm Types and Indicators

Alarm Type	Visual Indicators	Audible Indicator
<p><u>Low Alarm</u> Concentration of gas rises above the Low Alarm setting or falls below the Low Alarm setting for O₂.</p>	<ul style="list-style-type: none"> • ALRM1 alternately flashes with the channel's unit of measurement • The channel in alarm flashes its gas reading • Alarm LED arrays flash once per second • Backlight turns on 	Pulsing tone once per second
<p><u>High Alarm</u> Concentration of gas rises above the High Alarm setting.</p>	<ul style="list-style-type: none"> • ALRM2 alternately flashes with the channel's unit of measurement • The channel in alarm flashes its gas reading • Alarm LED arrays flash twice per second • Backlight turns on 	Pulsing tone twice per second
<p><u>TWA or STEL</u> Concentration of CO, H₂S, or other toxic gases rises above the TWA or STEL alarm setting.</p>	<ul style="list-style-type: none"> • Alarm LED arrays flash once per second • Backlight turns on • TWA or STEL alternately flashes with the channel's unit of measurement 	Pulsing tone once per second
<p><u>Over Range</u></p>	<ul style="list-style-type: none"> • OVER replaces the channel reading • Gas reading indicates full scale • Alarm LED arrays flash twice per second • Backlight turns on 	Pulsing tone twice per second
<p><u>Low Flow</u></p>	<ul style="list-style-type: none"> • The display indicates FAIL LOW FLOW LEVEL • Alarm LED arrays flash in a double pulsing pattern once per second • Backlight turns on 	Double pulsing tone once per second
<p><u>Low Battery Warning</u></p>	<ul style="list-style-type: none"> • The battery icon flashes. 	None
<p><u>Sensor Failure</u></p>	<ul style="list-style-type: none"> • FAILED SENSOR(S) appears at the top of the display and the failed sensor(s) are indicated • Alarm LED arrays flash in a double pulsing pattern once per second 	Double pulsing tone once per second
<p><u>Clock Failure</u></p>	<ul style="list-style-type: none"> • FAIL CLOCK appears at the bottom of the LCD • Alarm LEDs flash once per second 	Double pulsing tone once per second

Table 8: Alarm Types and Indicators

Alarm Type	Visual Indicators	Audible Indicator
<u>System Failure</u>	<ul style="list-style-type: none"> • FAIL SYSTEM appears at the bottom of the LCD and an error code displays in the middle of the LCD • Alarm LEDs flash once per second 	Double pulsing tone once per second

Responding to Alarms

This section describes response to gas, over range, battery, and sensor failure alarms.

Responding to Gas Alarms

1. Determine which gas alarm has been activated.
2. Follow your established procedure for an increasing gas condition or a decreasing oxygen condition.
3. If necessary, press **POWER** to reset the alarm once the alarm condition has passed.
 - a. If **Alarm Latching** is set to **On** (factory setting) in Setup Mode, the gas reading must fall below (or rise above for an oxygen low alarm) an alarm setting before the alarm can be reset.
 - b. If **Alarm Latching** is set to **Off** in Setup Mode, the alarm condition automatically resets when the gas reading falls below (or rises above for an oxygen low alarm) an alarm setpoint.

Responding to Over Range Alarms

WARNING: *An over range condition may indicate an extreme combustible gas, toxic gas, or oxygen concentration. Confirm a normal condition with a different EAGLE 3 or with another gas detecting device.*

CAUTION: *High off-scale readings may indicate an explosive concentration.*

PRUDENCE: *Des lectures élevées hors échelle peuvent indiquer une concentration explosive.*

1. Determine which channel is in alarm.
2. Follow your established procedure for an extreme gas condition.
3. Press **POWER** to reset the alarm once the alarm condition has cleared.
4. Calibrate the EAGLE 3 as described on page 79.
5. If the over range condition continues or if you are not able to successfully calibrate the unit, the sensor that has triggered the over range alarm may need to be replaced.

6. If the over range condition continues after sensor replacement, contact RKI Instruments, Inc. for further instructions.

Responding to Battery Alarms

WARNING: *The EAGLE 3 is not operational as a gas monitoring device during a dead battery alarm. Take the EAGLE 3 to a non-hazardous area and replace or recharge the batteries as described in “Recharging the EAGLE 3” on page 99.*

The EAGLE 3 is fully functional during a low battery warning. However, only a limited amount of operating time remains, approximately 1 - 2 hours. The amount of time depends on how often the LCD backlight is used and how often the unit is responding to alarm conditions. Recharge the lithium-ion battery pack as soon as possible as described on page 99.

NOTE: Alarms and the LCD back light consume battery power and reduce the amount of operating time remaining.

Responding to Clock Failure Alarms

A clock failure alarm occurs if the unit’s internal clock malfunctions. A clock failure alarm might also occur if the battery becomes too drained during storage. See page 108 for storage information.

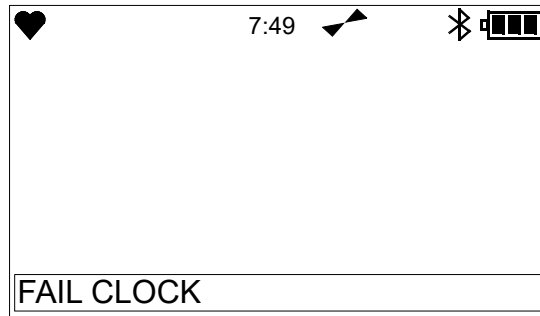

1. Press POWER to enter Normal Mode.

CAUTION: *If you operate the instrument after a clock failure, data will still be logged but the date/time will be incorrect. Set the date/time as described on page 118 as soon as possible to ensure logged data uses the correct date/time.*

2. Try to set the date using the **Set Date/Time** in **Setup Mode** as described on page 118.
3. If the date cannot be set correctly, contact RKI Instruments, Inc. as soon as possible.

Responding to Sensor Failure Alarms

1. Determine which sensor has triggered the sensor failure alarm.

2. Try calibrating the sensor as described on page 79.

If the sensor failure continues, replace the sensor as described on page 104.

CAUTION: *If the sensor failure continues after sensor replacement, contact RKI Instruments, Inc. for further instructions.*

Responding to System Failure Alarms

1. If a system failure occurs, an error code displays as shown below.

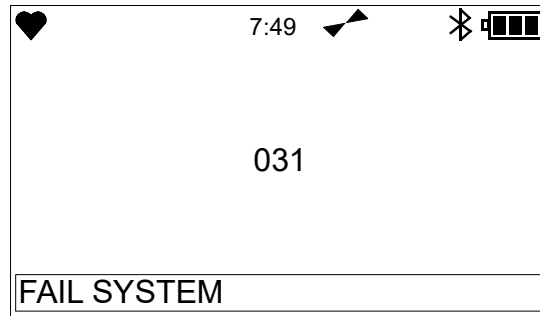

2. The error code meanings are shown in the table below.

Error Code	Explanation
000	ROM failure
010	RAM failure
021	FRAM failure
031	FLASH memory failure
080	Main board failure
081	Sensor board failure
082	Temperature sensor failure
083	Bluetooth failure

3. If the error code is anything but 031, the instrument cannot be used. Contact RKI Instruments, Inc. as soon as possible.

If the error code is 031, press POWER to continue into Normal Mode if the instrument must be used temporarily.

CAUTION: *There will be no datalogging function if you operate the instrument after a 031 system failure. Contact RKI Instruments, Inc. as soon as possible.*

Buzzer Silence

The alarms can be silenced through **Buzzer Silence** located in Setup Mode via the **Alarm Settings** menu (see page 132).

Table 9 summarizes resetting and silencing alarms for all **Alarm Latching** and **Buzzer Silence** setting combinations.

Table 9: Resetting and Silencing Alarms

	Alarm Latching: On (factory setting)	Alarm Latching: Off
Buzzer Silence: On	<ul style="list-style-type: none"> • Press POWER or AIR to silence the buzzer. • If the gas concentration was still above the alarm level when the button was pressed, the LED arrays continue to flash, the vibrator continues to pulse, and the EAGLE 3 continues to display the current alarm level. • The gas reading must fall below (or rise above for an oxygen low alarm) an alarm setting before you can reset the alarm, the LEDs, and the vibrator using the POWER or AIR buttons. 	<ul style="list-style-type: none"> • Press POWER or AIR buttons to silence the buzzer. • The POWER or AIR buttons will not reset the alarm. • The alarm, LEDs, and vibrator will automatically reset when gas reading falls below (or rises above for an oxygen low alarm) an alarm setpoint.
Buzzer Silence: Off (factory setting)	<ul style="list-style-type: none"> • Pressing POWER or AIR will not silence buzzer. • The gas reading must fall below (or rise above for an oxygen low alarm) an alarm setting before you can reset the alarm condition using the POWER or AIR buttons. 	<ul style="list-style-type: none"> • Pressing POWER or AIR will not silence buzzer. • The alarm condition will automatically reset when the gas reading falls below (or rises above for an oxygen low alarm) an alarm setpoint.

Data Logging

NOTE: The EAGLE 3 only logs data while in Normal Mode and will not log data while in Leak Check Mode or Bar Hole Mode.

The EAGLE 3 features the ability to log gas readings during normal operation in addition to alarm data and calibration data. This data can be downloaded to a computer via the communications/charging port on the side of the unit.

To download data from the EAGLE 3, the following are required:

- a USB-adaptor communication cable
- the EAGLE 3 Data Logger Management Program
- a computer with a USB port running one of the following operating systems: Windows 10 or Windows 11

The EAGLE 3 Data Logger Management Program is available for installation at www.rkiinstruments.com/eagle3.

The data logging capacity depends on how often the EAGLE 3 stores data, how many channels are active, and how often the EAGLE 3 is turned on and off. Table 10 illustrates how much data logging time is available for each interval of time. It assumes that the unit is setup with four sensors, is only turned on once, and there are no alarm occurrences. See page 142 for instructions on setting the data logging interval time.

Table 10: Interval/Data Logging Time

Interval Time	Data Logging Time
5 seconds	239 hours (10 days)
10 seconds	479 hours (20 days)
20 seconds	959 hours (40 days)
30 seconds	1439 hours (60 days)
1 minute	2879 hours (120 days)
3 minutes	8639 hours (360 days)
5 minutes	14,399 hours (600 days)
10 minutes	28,798 hours (2,000 days)

For a complete description of the Data Logger Management Program and procedures for downloading EAGLE 3 data to a computer, see the EAGLE 3 Data Logger Management Program Operator's Manual.

Chapter 4: Display Mode

This section describes the features of Display Mode. To enter this mode, press **DISPLAY** while in Normal Mode.

See Table 11 for a list of Display Mode's menu items, a short description of each item, and the page number for further description.

Table 11: Display Mode Menu Items

Display Screen Name	Function
Peak (page 60)	Displays each sensor's peak readings
Battery Voltage (page 61)	Displays the minimum operating and current battery voltage
CAT Sensor Protection (page 61)	Enables or disables the catalytic LEL sensor (if there is a TC or infrared combustible IR channel with a catalytic combustible channel)
Methane Elimination Mode (page 63)	Enables or disables Methane Elimination Mode (if the catalytic combustible gas channel is configured appropriately in the Configure Gases menu item in Setup Mode)
Relative Response (page 64)	Displays current combustible gas response factor that is applied to the catalytic sensors channel
STEL (page 66)	Displays the STEL readings (CO, H2S, and CO2/super toxic only)
TWA (page 66)	Displays the TWA readings (CO, H2S, and CO2/super toxic only)
View Alarm Settings (page 67)	Displays all current alarm setpoints
Change User ID (page 69)	Displays the current User ID and allows selection of a different User ID
Change Station ID (page 70)	Displays the current Station ID and allows selection of a different Station ID
View Calibration Dates (page 71)	Displays the most recent calibration date for each installed sensor
View Bump Test Dates (page 72)	Displays the most recent bump test date for each installed sensor
View Snap Log Data (page 73)	Displays each snap log recorded
Peak Bar (page 74)	Enables or disables the Peak Bar in Normal Mode
Bluetooth (page 75)	Enables or disables Bluetooth
Time In Operation (page 76)	Displays time in operation
Date/Time (page 76)	Displays date and time
Data Logging (page 77)	Displays the current snap log data saved to the instrument

Tips for Using Display Mode

- To scroll from one menu item to the next or skip an item when a question is asked, press or hold **DISPLAY**.
- To change a flashing parameter or move the on-screen cursor, press either **AIR** or **RANGE**.

- To select an option when a question is asked, press **POWER**.
- To exit Display Mode, press **DISPLAY** until the instrument returns to the current channel readings screen.

NOTE: Each Display Mode menu item displays for 20 seconds. If you do not press a button within 20 seconds while in Display Mode, the EAGLE 3 returns to Normal Mode

Viewing the Peak Screen

The Peak screen displays the highest (lowest for oxygen) concentrations detected since the EAGLE 3 was turned on. Peak readings are stored in the EAGLE 3's memory until a higher level is detected (lower for oxygen), the peak reading is cleared, or the EAGLE 3 is turned off.

NOTE: The **Lunch Break** feature allows the EAGLE 3 to save peak readings when it is turned off and continue to use these readings after it is turned back on. See page 174 for turning **Lunch Break** on and off.

To clear the peak readings, perform the following:

1. While in Normal Mode, press **DISPLAY** to display the **Peak** screen. All recorded peak readings will be displayed.

♥		7:49		📶		🔊	
CH4 %LEL	O2 %	CO ppm					
0	20.9	0					
H2S ppm	NH3 ppm						
0.0	0.0						
Peak							

2. Press **POWER**. The following prompt appears.

♥		7:49		📶		🔊	
Clear Peak							
Readings?							

3. Press **AIR** to clear the peak readings and proceed to the next screen in Display Mode. To return to the **Peak** screen without clearing the peak readings, press **DISPLAY**.

Viewing the Battery Voltage

The **Battery Voltage** screen displays the minimum operating voltage and the current battery voltage. When the unit's battery pack is fully charged, the screen will typically indicate 4.0 volts. This screen also displays during the warmup sequence.

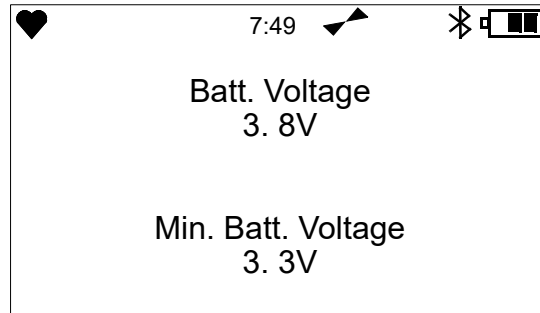

Catalytic (LEL) Sensor Protection

NOTE: This screen appears only when either a TC sensor or an infrared combustible sensor is installed in an EAGLE 3 with a catalytic combustible LEL sensor.

If the instrument is going to be exposed to known high-levels of combustible gas or operated in areas with known catalytic sensor poisons such as silicone vapors, the catalytic combustible sensor should be turned off. Even though this sensor has its own protective shut off, exposure to high levels of combustible gas can still stress the catalytic LEL sensor.

The catalytic LEL sensor can be enabled or disabled in the Catalytic (LEL) Sensor screen in Display Mode. The factory setting is **Enabled**.

1. While in Normal Mode, press **DISPLAY** until the Catalytic Sensor Protection parameter screen appears, which displays the current setting.

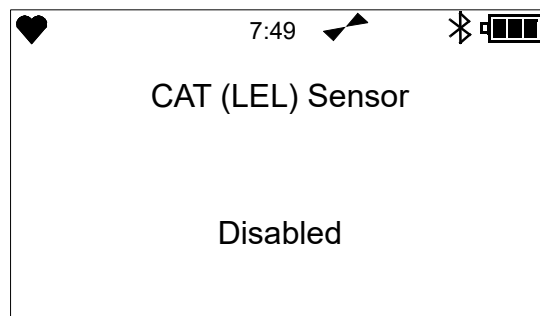

2. Press **AIR** to display the available settings. The current setting begins flashing.



3. Press **AIR** or **RANGE** to scroll to the desired setting.
4. To save the setting, press the **POWER** button. The unit will save the setting and return to the Catalytic Sensor Protection parameter screen.
To return to the Catalytic Sensor Protection parameter screen without changing the setting, press **DISPLAY**.

Adjusting the Methane Elimination Mode

This screen displays only if the EAGLE 3's catalytic combustible channel is setup for one of the gas types that supports methane elimination.

The standard setup for methane (CH₄) does not support methane elimination. When applicable, use this screen to enable and disable the methane elimination feature. See page 244 for more information.

1. While in Normal Mode, press **DISPLAY** until the Methane Elimination Mode parameter screen appears, which displays the current setting.

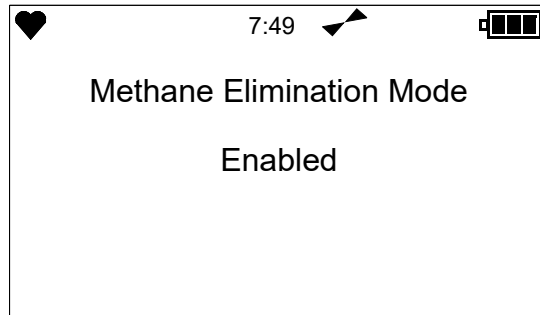

2. Press **AIR** to display the available settings. The cursor is next to the currently saved setting.

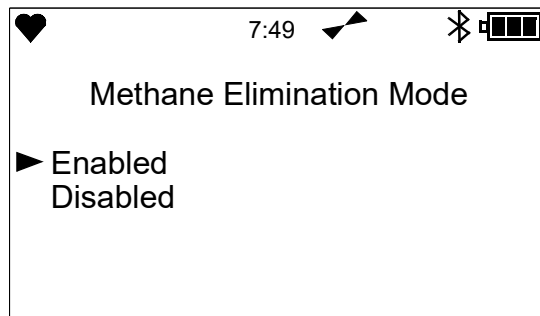

3. Press **AIR** or **RANGE** to scroll to the desired setting.
4. To save the setting, press the **POWER** button. The unit will save the setting and return to the Methane Elimination Mode screen.

To continue to return to the Methane Elimination Mode screen without changing the setting, press **DISPLAY**.

Catalytic Sensor Relative Response

NOTE: This screen displays only if **Relative Response** in Setup Mode is set to **On** (see page 127). Use this screen to temporarily change the gas configuration of the catalytic combustible channel.

NOTE: If Methane Elimination Mode is enabled, the **Catalytic Sensor Relative Response** screen does not appear.

A list of gases with responses relative to the configured gas, normally methane, is programmed into the EAGLE 3's memory. This includes several pre-defined gases and 5 gases that can be entered into the EAGLE 3 in the field. In order to program a field-defined gas into the EAGLE 3, gas testing must be performed to determine the gases' response factor relative to methane.

The following is the complete list of factory-defined gases:

- Acetone
- Benzene
- Butyl Acrylate
- Butyl Acetate
- 2-Butyl Alcohol
- 1-Butyl Alcohol
- Cyclohexane
- Cumene
- Ethylene Dichloride
- Ethyl Alcohol
- Ethyl Chloride
- Ethyl Acrylate
- Hexane
- Hydrogen
- Isobutane
- Isopropanol
- Methane
- Methanol
- Methyl Acetate
- Methyl Acrylate
- Methyl Ketone
- Methyl Ibutyl Ketone
- Nonane
- Pentane
- Propane
- Styrene
- Toluene
- Vinyl Acetate
- Mixed Xylenes
- Field Defined Gas
- Field Defined Gas
- Field Defined Gas
- Field Defined Gas
- Field Defined Gas

Contact RKI Instruments, Inc. for details regarding the gas testing and programming of user-defined gases into the EAGLE 3's relative response list. The last five items in the gas list are reserved for field-defined gases.

The relative response feature enables the instrument to temporarily monitor for the selected gas without needing recalibration. The EAGLE 3 will clear the gas configuration change when it is turned off and will return to the programmed configuration when it is turned on again.

Because of normal variation between sensors, these relative response factors are typical factors. If you use this feature, the response to the selected gas will not be as accurate as it would be if you configured and calibrated the catalytic combustible channel to the target gas.

NOTE: For maximum accuracy, configure and calibrate the EAGLE 3's catalytic combustible channel to the desired target gas.

1. While in Normal Mode, press **DISPLAY** to scroll to the **Relative Response** screen.

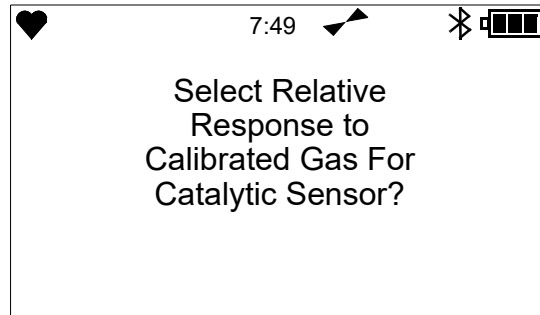

2. Press **AIR** to select the menu item. A list of gases will appear on the screen. There are multiple screens of gases.

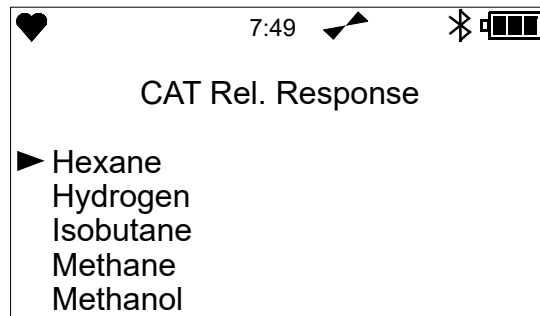

3. Press **AIR** or **RANGE** to scroll to the desired gas.
4. Press **POWER** to select the desired gas. The catalytic combustible channel will be configured to the selected gas and the EAGLE 3 will proceed to the STEL Screen.

This configuration will be in force until a different gas is selected in Display Mode or the unit is turned off.

NOTE: If a PID sensor is installed in the EAGLE 3 and **Relative Response** is set to **On** in Setup Mode, a PID Sensor Relative Response Screen appears after the Catalytic Sensor Relative Response Screen. If **Relative Response** is set to **Off**, the PID Sensor Relative Response Screen will still appear after the Methane Elimination Mode Screen. See pg. 129 for a description of the relative response feature for the PID sensor.

Viewing the Short-Term-Exposure-Limit (STEL)

The STEL Screen displays the short term exposure limit (STEL) readings for H_2S , CO , CO_2 , and *super toxic channels only*. The STEL reading is the average reading over the last 15 minutes.

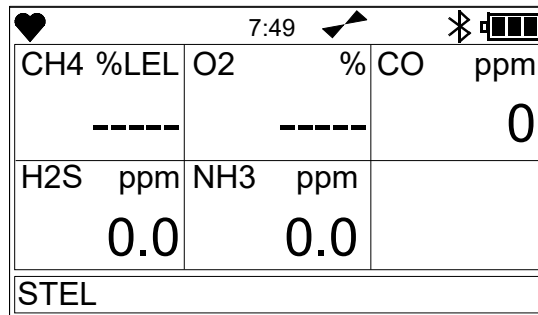

The screenshot shows a mobile device interface with a status bar at the top displaying a heart icon, the time 7:49, a signal strength indicator, a Bluetooth icon, and a battery level icon. Below the status bar is a table with the following data:

CH4 %LEL	O2 %	CO ppm
-----	-----	0
H2S ppm	NH3 ppm	
0.0	0.0	
STEL		

Viewing the Time-Weighted-Average (TWA)

NOTE: If **Lunch Break** is set to **On**, the EAGLE 3 will remember TWA readings when it is turned off so it can continue them when it is turned on again. See page 174 for instructions to turn the lunch break feature on.

The TWA Screen displays the time weighted average (TWA) readings for H_2S , CO , CO_2 , and *super toxic channels only*.

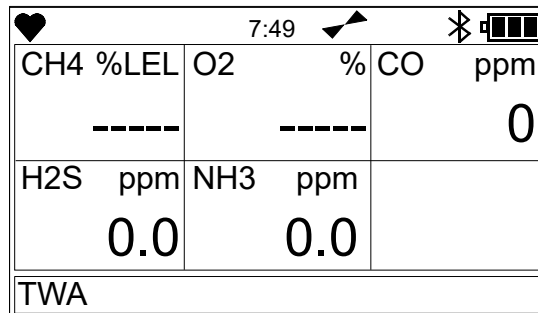

The screenshot shows a mobile device interface with a status bar at the top displaying a heart icon, the time 7:49, a signal strength indicator, a Bluetooth icon, and a battery level icon. Below the status bar is a table with the following data:

CH4 %LEL	O2 %	CO ppm
-----	-----	0
H2S ppm	NH3 ppm	
0.0	0.0	
TWA		

The TWA reading is the average reading *over the last 8 hours*. If 8 hours have not elapsed since the last time the TWA reading was cleared, the average is still calculated over 8 hours. The missing readings are assigned a 0 value. If **Lunch Break** is set to **Off** (factory setting), the TWA is cleared when the EAGLE 3 is turned off.

Viewing the Alarm Settings

The View Alarm Settings screen shows the gas alarm points for all active channels.

To view the gas alarm settings, perform the following:

1. While in Normal Mode, press DISPLAY to scroll to the **Alarm Settings** screen.

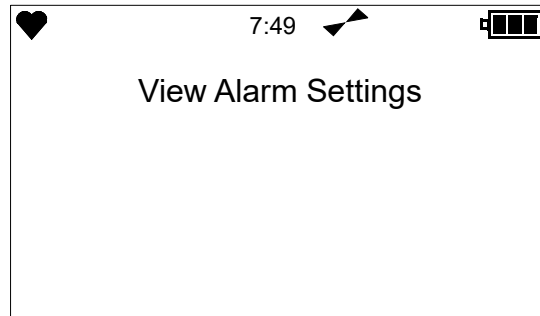

2. Press AIR to enter the **View Alarm Settings** menu. The **Full Scale** alarm settings screen appears.

- Press **AIR** to scroll through the Alarm Settings screens. The screens appear in the order shown below: **Full Scale**, **Alarm 1**, **Alarm 2**, **STEL**, and **TWA**.

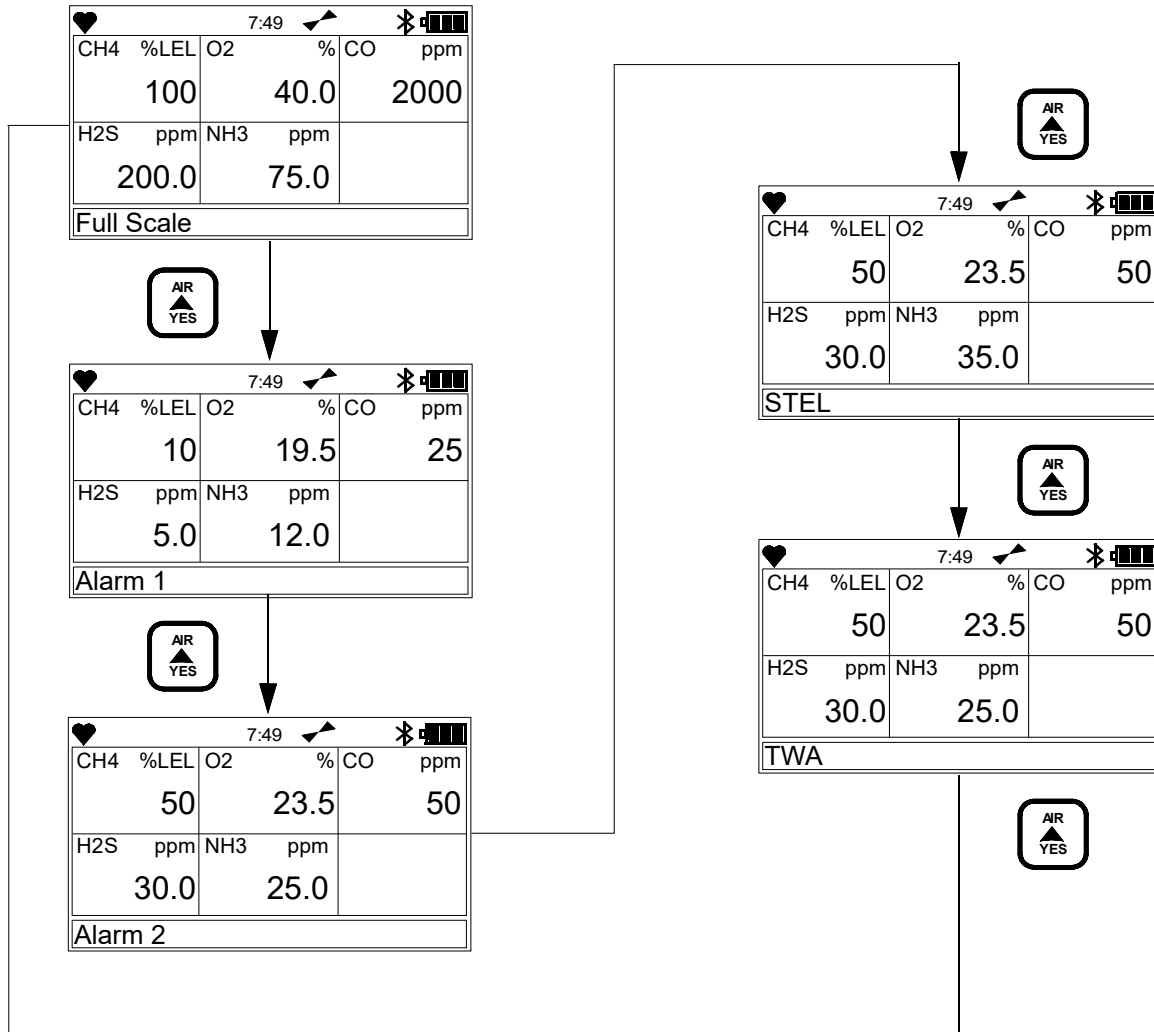

While viewing the alarm settings for a particular alarm point, press **AIR** and **POWER** at the same time to simulate the alarm conditions. The buzzer will sound and the LEDs will flash just as it would if the displayed condition was actually happening.

- To return to the **View Alarm Settings?** menu item, press **DISPLAY** on any alarm settings screen.

Viewing and Changing the User ID

NOTE: The **Change User ID?** screen displays only if **User and Station ID** in the Setup Mode menu is set to ON (see page 138).

A user ID is a way to identify different users and their saved data logs on the instrument.

Use this screen to select a user ID from the 128 user IDs stored in the EAGLE 3's memory. Before a user ID is selected on a brand new instrument, the instrument's user ID is "-----". Factory-installed user IDs have a "**User ID XXX**" format.

User IDs can only be selected in this menu item. The EAGLE 3 Datalogging Program is required to edit the user IDs.

NOTE: For a detailed description of data logging and editing user IDs, see the EAGLE 3 Data Logger Management Program Operator's Manual.

To select a different user ID, perform the following:

1. While in Normal Mode, press DISPLAY to scroll to the **Change User ID** screen.

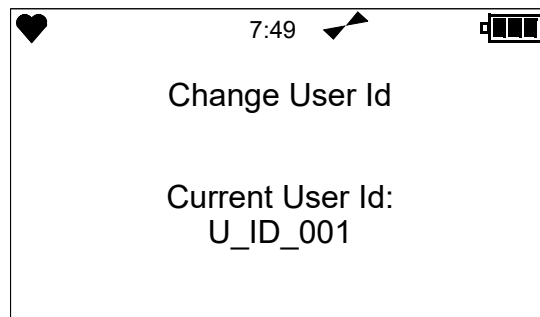

2. Press AIR to enter the **Change User ID** menu. The **Change User ID** screen appears with the cursor next to the current user ID in use.

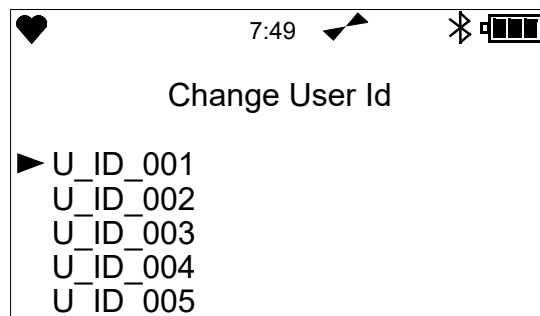

3. Press AIR or RANGE to scroll through the list of user IDs until the cursor is next to the desired user ID.
4. Press **POWER** to save the desired user ID and proceed to the Select Station ID screen.
To return to the **Change User ID** screen without changing the user ID, press **DISPLAY**.

Viewing and Changing the Station ID

NOTE: The **Change Station ID?** screen displays only if **User and Station ID** in the Setup Mode menu is set to **ON** (see page 138).

A station ID provides a way to identify the EAGLE 3's location during a data logging session. Use this screen to select a station ID from the 128 station IDs stored in the EAGLE 3's memory. Before a station ID is selected on a brand new instrument, the instrument's station ID is "-----". Factory-installed station IDs have a "Station ID XXX" format.

Station IDs can only be selected in this menu item. The EAGLE 3 Datalogging Program is required to edit the station IDs.

NOTE: For a detailed description of data logging and station IDs, see the EAGLE 3 Data Logger Management Program Operator's Manual.

To select a different station ID, perform the following:

1. While in Normal Mode, press **DISPLAY** to scroll to the **Change Station ID** screen appears.

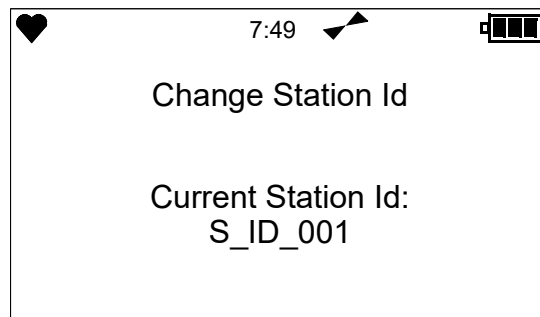

2. Press **AIR** to enter the **Change Station ID** menu. The **Change Station ID** screen appears with the cursor next to the current station ID in use.

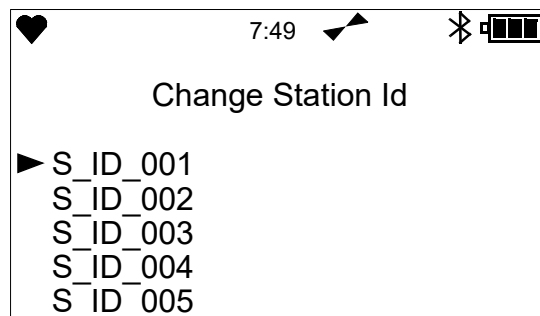

3. Press **AIR** or **RANGE** to scroll through the list of station IDs until the cursor is next to the desired station ID.
4. Press **POWER** to save the desired station ID and proceed to the next Display Mode screen.
To return to the **Change Station ID** screen without changing the station ID, press **DISPLAY**.

View Calibration Dates

Use this menu to view each sensor's most recent calibration date.

1. While in Normal Mode, press **DISPLAY** to scroll to the **View Calibration Date** screen.

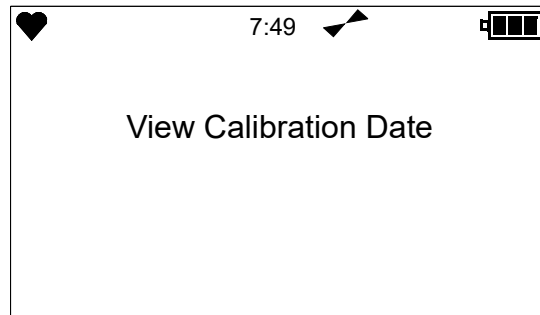

2. Press **AIR** to scroll to view each sensor's **Calibration Date** screen.

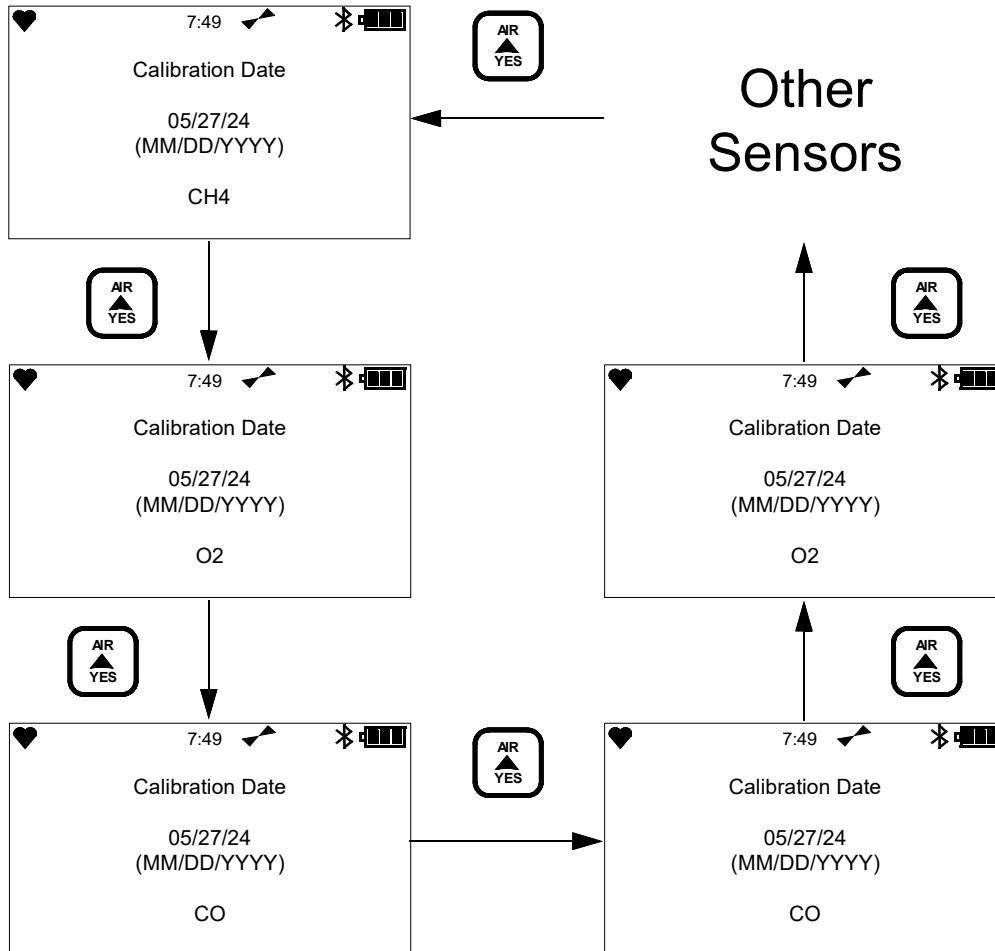

3. Press **DISPLAY** to return to the **View Calibration Dates** screen in Display Mode.

View Bump Test Dates

Use this menu to view each sensor's most recent bump test date.

1. While in Normal Mode, press **DISPLAY** to scroll to the **View Bump Test Dates?** screen.

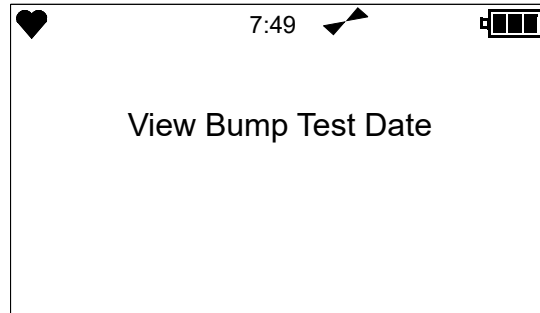

2. Press **AIR** to scroll to the desired sensor's **Bump Test Date** screen. Each screen shows a different sensor's recorded bump test dates.

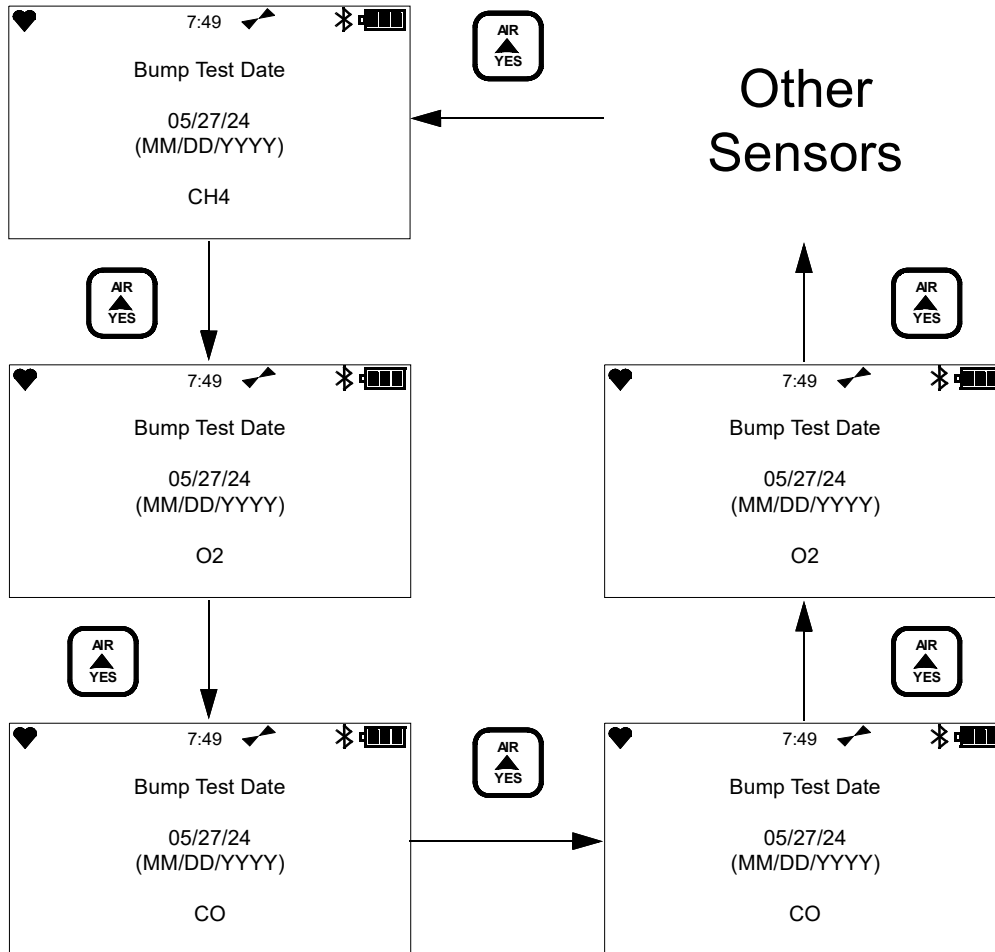

3. Press **DISPLAY** to return to the **View Calibration Dates?** screen in Display Mode.

View Snap Log Data

The EAGLE 3 is capable of logging all channel readings at a given moment. The EAGLE 3 can store up to 256 snap logs at one time. If **Data Log Overwrite** (page 143) is set to On, the oldest log will be overwritten by the newest snap log.

To view a snap log, perform the following:

1. While in Normal Mode, press **DISPLAY** until the View Snap Log Data Screen appears.

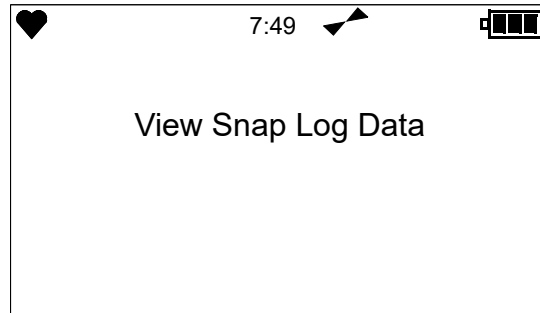

2. Press the **POWER** or **AIR** buttons. The following screen appears.

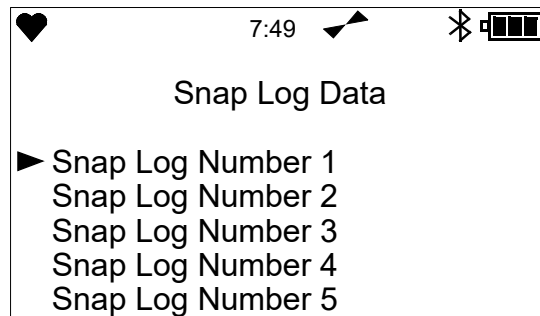

3. Press the **RANGE** button to cycle through list of recorded Snap Logs. Press **POWER** or **AIR** buttons to select one of the Snap Log Numbers to view.

To return to the Snap Log Data list, press **POWER**. To return to Display Mode, press **DISPLAY**.

Peak Bar

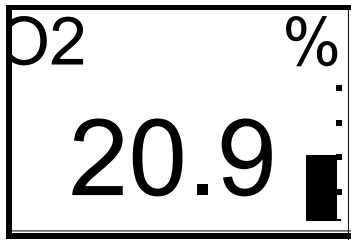

The Peak Bar screen enables or disables the peak bar. If the function is turned on, the peak bar appears along the right side of each gas reading in Normal Mode, representing the peak of each channel.

1. While in Normal Mode, press **DISPLAY** until the Peak Bar parameter screen appears, which displays the current setting.

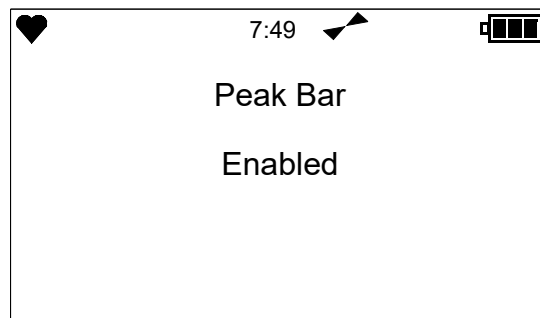

2. Press **AIR** to display the available settings. The cursor is next to the currently saved setting.

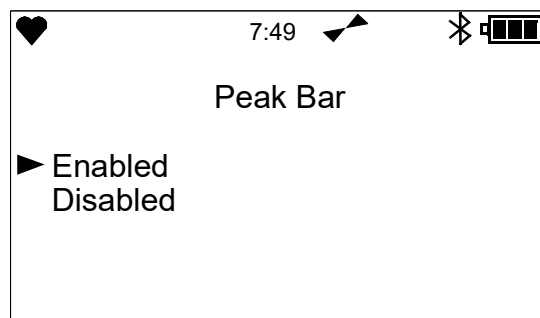

3. Press **AIR** or **RANGE** to scroll to the desired setting.
4. To save the setting, press the **POWER** button. The unit will save the setting and return to the Peak Bar screen.

To continue to return to the Peak Bar screen without changing the setting, press **DISPLAY**.

Turning Bluetooth On/Off (Bluetooth)

The **Bluetooth** screen allows the EAGLE 3's Bluetooth functionality to be enabled and disabled.

On: Turns Bluetooth functionality on, allowing for connection to the RK Link phone application.

NOTE: If BLE Auto Shut Off When Idle, accessible in the Datalogging or SDM-E3 Program, is selected (factory setting) and the EAGLE 3 does not pair to a phone in the first 5 minutes after warmup, the EAGLE 3's Bluetooth shuts off to conserve battery life.

If BLE Auto Shut Off When Idle, accessible in the Datalogging or SDM-E3 Program, is deselected and if the EAGLE 3 does not pair to a phone, the EAGLE 3's Bluetooth stays on indefinitely.

1. While in Normal Mode, press **DISPLAY** until the Bluetooth parameter screen appears, which displays the current setting.

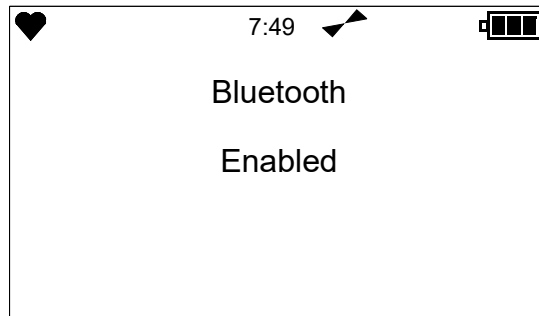

2. Press **AIR** to display the available settings. The cursor is next to the currently saved setting.

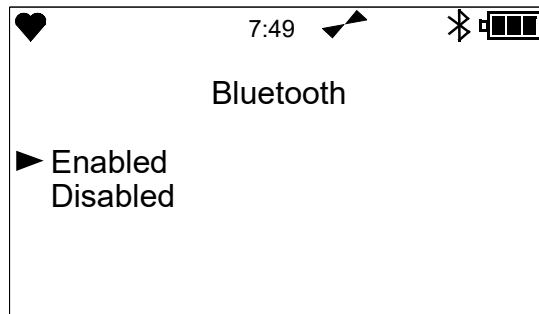

3. Press **AIR** or **RANGE** to scroll to the desired setting.
4. To save the setting, press the **POWER** button. The unit will save the setting and return to the Bluetooth screen.

To continue to return to the Bluetooth screen without changing the setting, press **DISPLAY**.

Time in Operation Screen

The Time In Operation Screen displays the length of time since the EAGLE 3 was turned on if the Lunch Break is turned off.

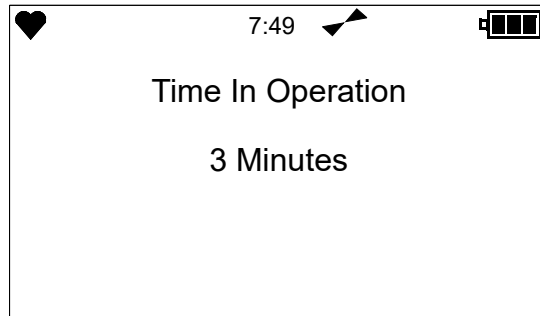

If the lunch break feature is turned on, the time in operation will only be reset if you do not choose to resume the peak and TWA measurements when the EAGLE 3 is turned on in the Resume Measurement Screen described in Step 7 on page 31.

If you choose to resume the peak and TWA measurements during warmup, the EAGLE 3 will include the time in operation when the unit was last turned off in the current time in operation.

See page 174 for a description of the lunch break feature.

Date/Time Screen

The Date/Time Screen displays the current date and time.

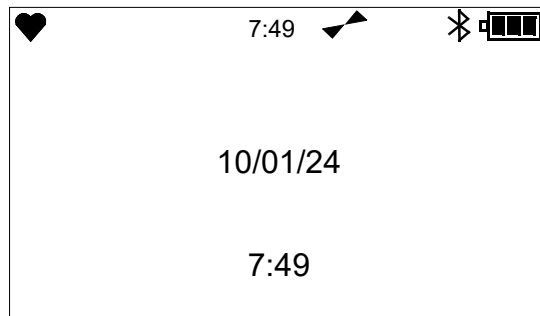

Data Logging Screen

***CAUTION:** Once you clear the data logger, you cannot retrieve any data previously stored in the data logger.*

The Data Logging screen displays the time remaining until the data logger memory is full and asks if you want to clear the data logger memory.

To clear the data logger memory, do the following:

1. While in Normal Mode, press **DISPLAY** until the Data Logging screen appears.

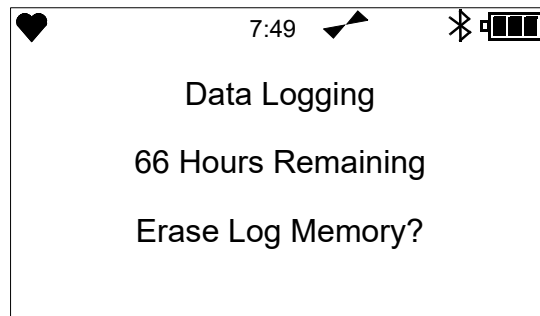

2. Press **AIR** to proceed to the confirmation screen.

To continue return to Normal Mode without erasing the stored data, press **DISPLAY**.

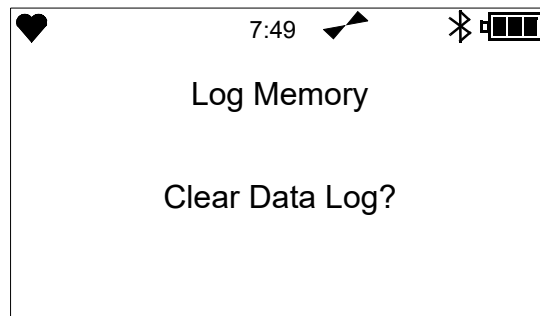

3. The confirmation screen appears. Press **AIR** to erase all stored data saved to the EAGLE 3.

To return to the Data Logging screen, press **DISPLAY**.

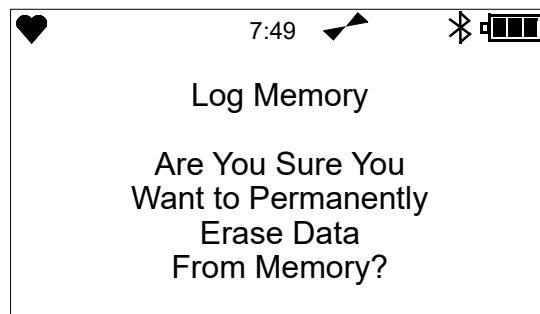

4. The screen displays the “**Cleared**” text before returning to Normal Mode.

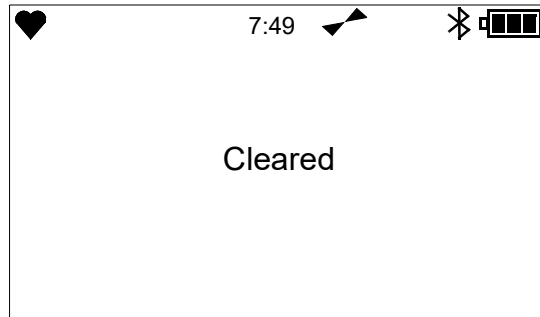

Chapter 5: Calibration Mode

Overview

This section describes the EAGLE 3 in Calibration Mode. See Table 12 for a list of the items found in Calibration Mode, the page that each menu item's instructions can be found on, and a short description of each menu item.

Table 12: Calibration Mode Menu Items

Calibration Mode Menu Item	Function
Bump (page 80)	Perform a bump test.
Air Cal (page 87)	Perform a fresh air adjustment on all channels.
CO2 Zero Calibration (page 90)	Perform a zero adjustment on the CO ₂ sensor. <i>NOTE: This menu item only appears if a CO₂ sensor is installed.</i>
TE Base Calibration (page 90)	Perform a zero adjustment on the TE sensor. <i>NOTE: This menu item only appears if a TC sensor is installed.</i>
Span Cal (page 91)	Perform a span adjustment for all channels.
Set Span Cal Values (page 93)	Adjust each channel's auto calibration values.
Cylinder Select (page 94)	Assign a cylinder (A-E) to each gas (all 4 gases set to Cylinder A is the default).
Normal Operation (page 96)	Begin the warmup sequence and enter Normal Mode.

Entering Calibration Mode

1. Find a fresh-air environment. This is an environment free of toxic or combustible gases and of normal oxygen content (20.9%).
2. While in Normal Mode, press and hold **RANGE** then press **DISPLAY**.
3. If the unit prompts you for the password, enter it by using **AIR** and **RANGE** to scroll through each digit and then press **POWER** to enter the number and move to the next one.

Press **DISPLAY** to return to the previous number entered.

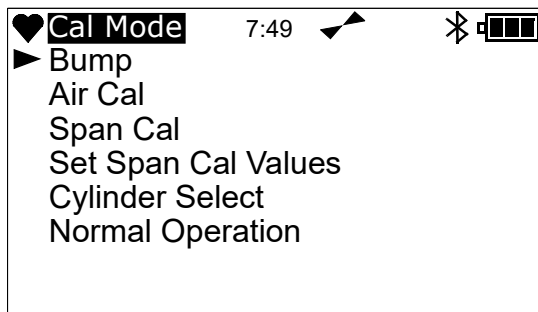

4. The Calibration Mode Screen displays with the cursor next to **Bump Test**.

NOTE: The following screens illustrate a four-gas EAGLE 3 for detection of CH₄ (% LEL using catalytic sensor), oxygen, CO, H₂S, and NH₃. Your EAGLE 3 may display slightly different screens.

Performing a Bump Test

Bump test the instrument before each day's use with a known concentration of each target gas. The instrument does not need to be calibrated unless it does not pass the bump test.

To bump test the EAGLE 3, you will need:

- Known calibrating samples of the gases being detected

Table 13: Standard 4-Gas Calibration Concentrations

Target Gas	Min. Cal. Gas Concentration	Max. Cal. Gas Concentration
Combustible Gas	1% LEL	75% LEL
Oxygen	0.0%	17.0%
Carbon Monoxide	0 ppm	2,000 ppm
Hydrogen Sulfide	0 ppm	200.0 ppm

NOTE: For calibration information on non-standard sensors (PID, ESF, IR, etc.), refer to the appropriate appendix.

- Demand flow regulator
 - Non-absorbent tubing
 - Sample hose and probe
1. Confirm that the EAGLE 3's calibration gas values match the concentrations listed on the calibration gas cylinder(s). If they do not match, adjust them as described on page 93.
 2. Confirm that your cylinder selections are appropriate as described on page 94.
 3. Install the demand flow regulator onto the calibration cylinder.
 4. Connect the sample tubing to the demand flow regulator.
 5. Install the sample hose and probe onto the EAGLE 3 inlet fitting. Make sure the probe is complete with internal O-ring and membrane and that the two halves of the probe are tightened firmly together to avoid leaks that can affect the calibration. See Figure 18 on page 100 for an illustration of the internal parts of the probe.

6. While in Calibration Mode, press **AIR** or **RANGE** to scroll to **Bump**.

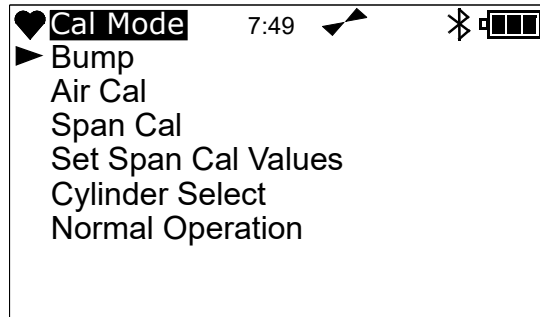

7. Press **POWER**. The **Bump** screen shows the gases assigned to Cylinder A and their assigned calibration values (see page 93 if the bump test values do not match the calibration gas cylinder's concentrations).

Cal Mode			
CH4 %LEL	O2 %	CO	ppm
50	12.0	50	
H2S ppm	NH3 ppm		
25.0	40.0		
Bump		Cylinder A	

8. If necessary, use **AIR** to scroll to a different cylinder screen for the gas(es) you want to bump test. As shipped from the factory, the standard 4 gases (combustible gas, O₂, CO, and H₂S) are assigned to Cylinder A.

NOTE: If a H₂-compensated CO sensor is installed, H₂ is assigned to Cylinder D but there is no reason to bump test the H₂ response. Toxic sensors are assigned to Cylinder D or Cylinder E.

9. Make sure the EAGLE 3 has been turned on for at least 45 seconds before continuing.
10. Connect the sample tubing from the demand flow regulator to the EAGLE 3's connected probe then quickly press **POWER** to begin the bump test countdown.

11. The gas readings flash and the bottom of the screen displays **Bump, Apply Gas**, and a countdown defined by the **GasTime** menu item in **Setup Mode** (see page 156).

NOTE: To return to the **Cal Mode** menu without performing the bump test, press **DISPLAY**.

♥ Cal Mode		7:49	↗	⌘	🔋
CH4 %LEL	O2	%	CO	ppm	
0	20.9		0		
H2S ppm	NH3	ppm			
0.0	0.0				
Bump		Apply Gas	29		

12. At the end of the countdown, the instrument analyzes the results. Follow the flow chart to determine the bump test outcome.

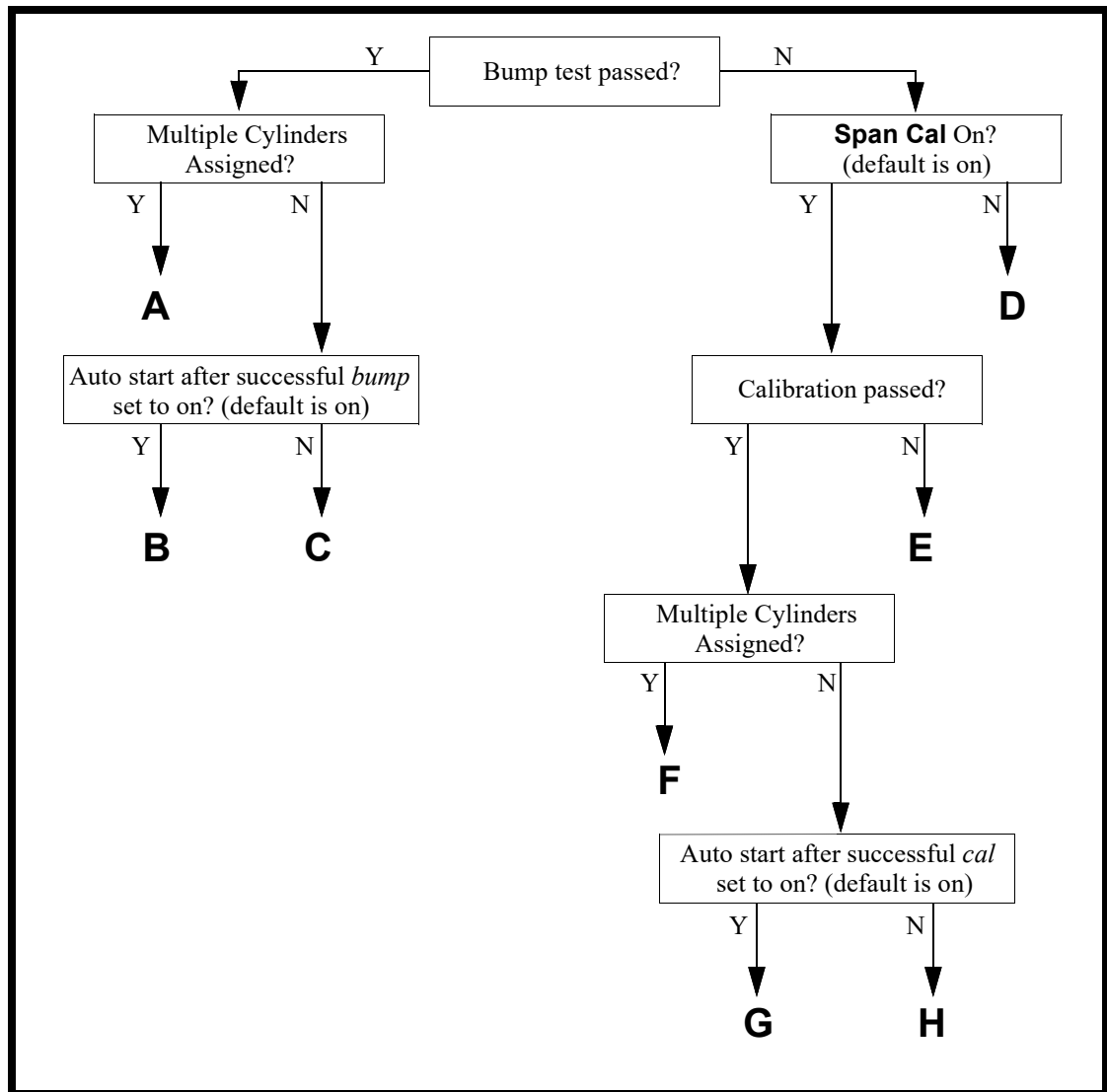
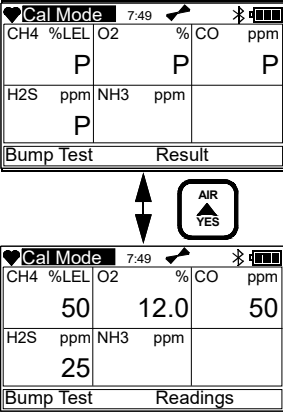
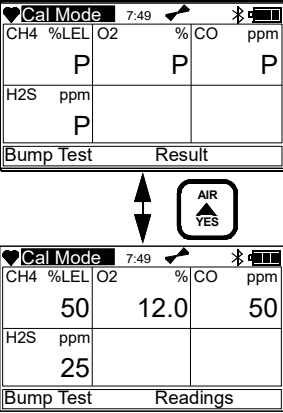
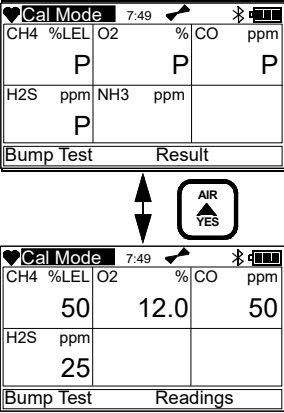
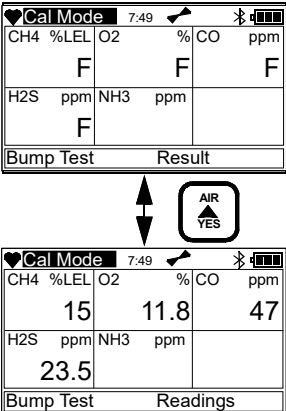
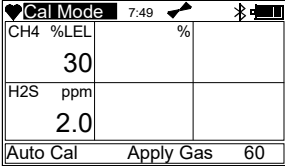
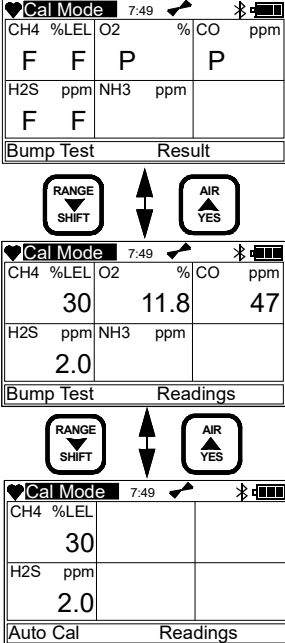
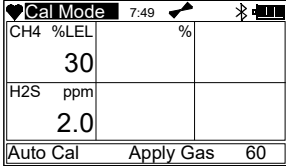
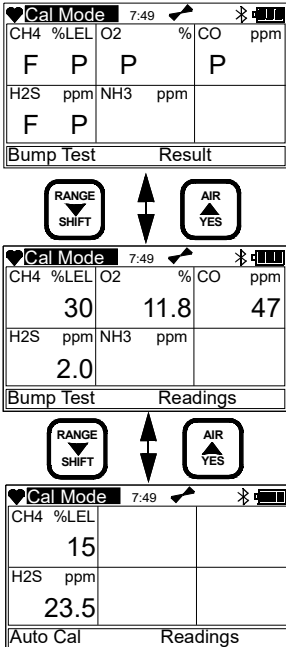
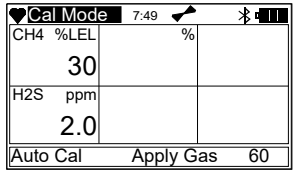
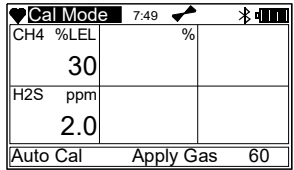
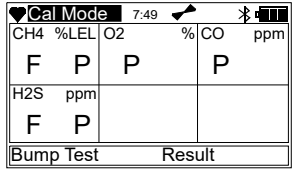
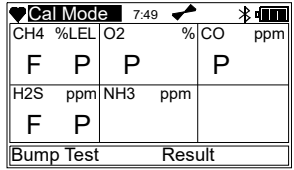

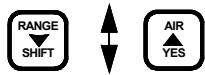
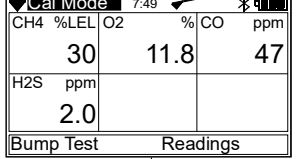
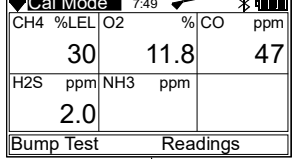

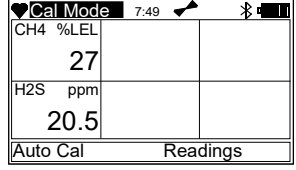
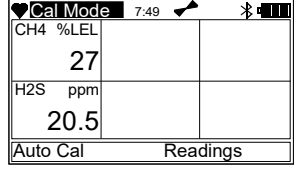

Figure 17: Bump Test Flow Chart

Option A from Flow Chart	Option B from Flow Chart	Option C from Flow Chart
<ul style="list-style-type: none"> • Bump test passed • Multiple cylinders assigned 	<ul style="list-style-type: none"> • Bump test passed • One cylinder assigned • Bump Auto Start set to On (factory setting) 	<ul style="list-style-type: none"> • Bump test passed • One cylinder assigned • Bump Auto Start set to Off (factory setting is On)
<p>1. The instrument indicates that all channels passed the bump test. Press AIR or RANGE to scroll between the bump test results and the bump test gas readings.</p> <div style="text-align: center;">  </div> <ol style="list-style-type: none"> 2. Disconnect the tubing from the probe. 3. Press POWER to move to the Bump Test Cylinder X screen for the next cylinder. 4. Unscrew the regulator from the first cylinder and screw it into the next cylinder. 5. Repeat Step 10 through Step 12. 6. Disconnect the sample tubing from the probe. 7. Press POWER to enter Normal Mode. 	<p>1. The instrument indicates that all channels passed the bump test. Press AIR or RANGE to scroll between the bump test results and the bump test gas readings.</p> <div style="text-align: center;">  </div> <ol style="list-style-type: none"> 2. Disconnect the tubing from the probe. 3. Unscrew the regulator from the calibration cylinder. 4. Press POWER to enter Normal Mode. 	<p>1. The instrument indicates that all channels passed the bump test. Press AIR or RANGE to scroll between the bump test results and the bump test gas readings.</p> <div style="text-align: center;">  </div> <ol style="list-style-type: none"> 2. Disconnect the tubing from the probe. 3. Unscrew the regulator from the calibration cylinder. 4. Press POWER to move to the Normal Operation screen in the Bump Test menu. 5. Press POWER to enter Normal Mode.

Option D from Flow Chart	Option E from Flow Chart	Option F from Flow Chart
<ul style="list-style-type: none"> • Bump test failed • Auto Calibration set to Off (factory setting is On) 	<ul style="list-style-type: none"> • Bump test failed • Auto Calibration set to On (factory setting) • Calibration failed 	<ul style="list-style-type: none"> • Bump test failed • Auto Calibration set to On (factory setting) • Calibration passed • Multiple cylinders assigned
<p>1. The instrument shows which channels passed or failed the bump test. The LEDs flash and the buzzer sounds. Press AIR or RANGE to scroll between the results and the readings.</p>  <p>2. Disconnect the tubing from the probe.</p> <p>3. Unscrew the regulator from the calibration cylinder.</p> <p>4. Press POWER to return to the Bump Test Cylinder X screen.</p> <p>5. Press POWER to return to the Bump Test menu.</p> <p>6. Press RANGE to scroll to Normal Operation and press POWER to enter Normal Mode.</p> <p>7. Calibrate the EAGLE 3 as soon as possible.</p>	<p>1. A calibration immediately and automatically starts. Continue to apply the calibration gas.</p> <p>2. The calibration time is the difference between the GasTime and the Cal Time values defined in the Bump Settings menu item in Setup Mode.</p>  <p>3. The instrument shows which channels passed or failed the bump test/calibration. The LEDs flash and the buzzer sounds. Press AIR or RANGE to scroll between the results and the readings.</p>  <p>4. Disconnect the tubing from the probe.</p> <p>5. Unscrew the regulator from the calibration cylinder.</p> <p>6. Press POWER to return to the Bump Test menu.</p> <p>7. Press RANGE to scroll to Normal Operation and press POWER to enter Normal Mode.</p>	<p>1. A calibration immediately and automatically starts. Continue to apply the calibration gas.</p> <p>2. The calibration time is the difference between the GasTime and the Cal Time values defined in the Bump Settings menu item in Setup Mode.</p>  <p>3. The instrument shows which channels passed or failed the bump test/calibration. Press AIR or RANGE to scroll between the results and the readings.</p>  <p>4. Disconnect the tubing from the probe.</p> <p>5. Press POWER to move to the Bump Test Cylinder X screen for the next cylinder.</p> <p>6. Unscrew the regulator from the first cylinder and screw it into the next cylinder.</p> <p>7. Repeat Step 10 through Step 12.</p> <p>8. Press AIR to scroll to Normal Operation screen and press POWER to enter Normal Mode.</p>

Option G from Flow Chart	Option H from Flow Chart
<ul style="list-style-type: none"> • Bump test failed • Auto Cal set to On (factory setting) • Calibration passed • One cylinder assigned • Bump Auto Start set to On (factory setting) 	<ul style="list-style-type: none"> • Bump test failed • Auto Cal set to On (factory setting) • Calibration passed • One cylinder assigned • Bump Auto Start set to Off (factory setting is On)
<ol style="list-style-type: none"> 1. A calibration immediately and automatically starts. Continue to apply the calibration gas. 2. The calibration time is the difference between the GasTime and the Cal Time values defined in the Bump Settings menu item in Setup Mode. 	<ol style="list-style-type: none"> 1. A calibration immediately and automatically starts. Continue to apply the calibration gas. 2. The calibration time is the difference between the GasTime and the Cal Time values defined in the Bump Settings menu item in Setup Mode.
	
<ol style="list-style-type: none"> 3. The instrument shows which channels passed or failed the bump test/calibration. Press AIR or RANGE to scroll between the results and the readings. 	<ol style="list-style-type: none"> 3. The instrument shows which channels passed or failed the bump test/calibration. Press AIR or RANGE to scroll between the results and the readings.
	
	
	
	
	
<ol style="list-style-type: none"> 4. Disconnect the tubing from the probe. 5. Unscrew the regulator from the calibration cylinder. 6. Press POWER to enter Normal Mode. 	<ol style="list-style-type: none"> 4. Disconnect the tubing from the probe. 5. Unscrew the regulator from the calibration cylinder. 6. Press POWER to return to the Bump Settings menu. Scroll to the Normal Mode menu item.
	<ol style="list-style-type: none"> 7. Press POWER to enter Normal Mode.

Performing a Calibration

CO₂ Zero Calibration

NOTE: This menu item only appears in Calibration Mode if a CO₂ sensor is installed.

1. While in Calibration Mode, press **AIR** or **RANGE** to scroll to **CO2 Zero Cal**.

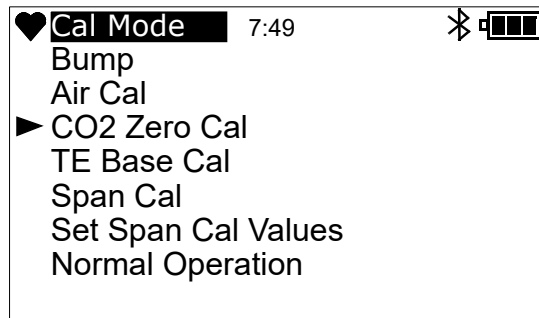

2. Press **POWER**. The **CO2 Zero Cal** screen displays the zero reading assigned to the CO₂ channel.

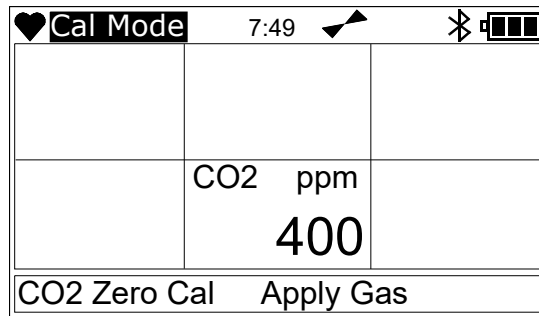

3. Make sure the EAGLE 3 has been turned on for at least 45 seconds before continuing.
4. Connect the sample tubing from the demand flow regulator to the EAGLE 3's connected probe then press **POWER** to begin applying gas.
5. If all channels pass the fresh air adjustment, the instrument displays a “**Pass**” message and returns to the **Cal Mode** menu.

If the fresh air adjustment fails, “**Fail**” displays if the CO₂ channel failed. Press **POWER** to acknowledge the failure. See “Troubleshooting” on page 97.

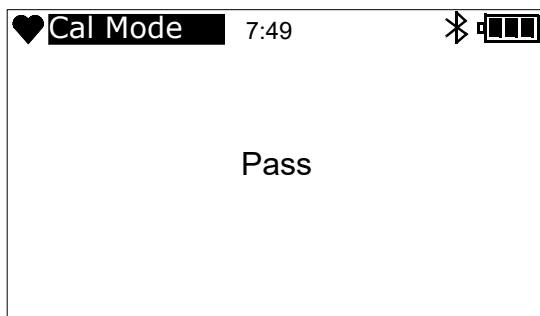

OR

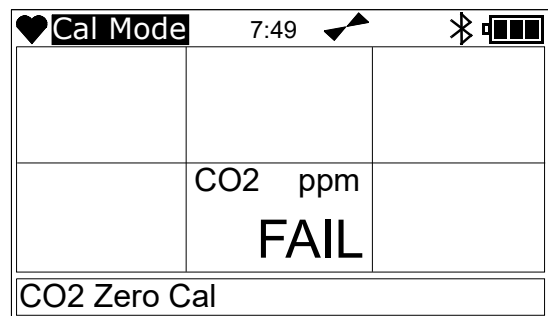

Performing a TE Base Calibration

NOTE: This menu item only appears in Calibration Mode if a TE sensor is installed.

1. While in Calibration Mode, press **AIR** or **RANGE** to scroll to **TE Base Cal**.

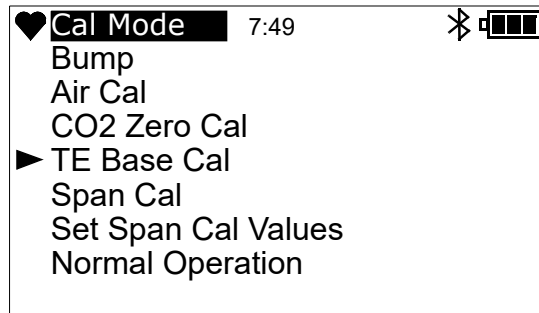

2. Press **POWER**. The **TE Base Cal** screen displays the zero reading assigned to the TE sensor's channel.

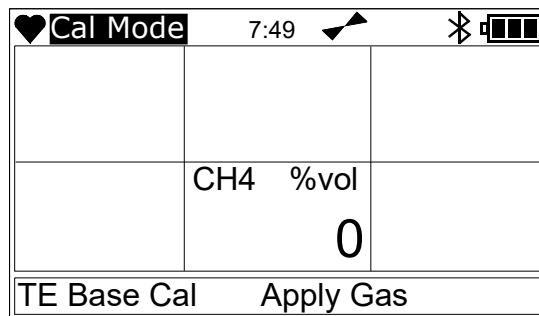

3. Make sure the EAGLE 3 has been turned on for at least 45 seconds before continuing.
4. Connect the sample tubing from the demand flow regulator to the EAGLE 3's connected probe then press **POWER** to begin applying gas.
5. If all channels pass the fresh air adjustment, the instrument displays a "**Pass**" message and returns to the **Cal Mode** menu.

If the fresh air adjustment fails, "**Fail**" displays if the TE channel failed. Press **POWER** to acknowledge the failure. See "Troubleshooting" on page 97.

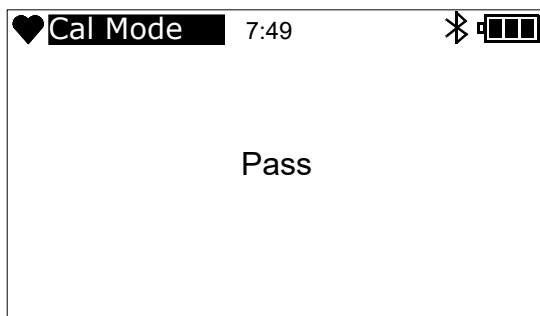

OR

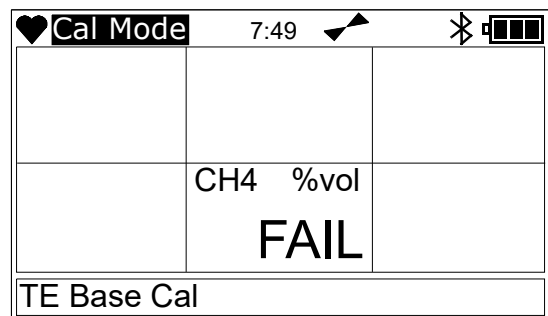

Performing a Span Calibration

Preparing for a Calibration

- To fully calibrate the sensors, you must do a fresh air adjustment (**Air Cal**) and a span adjustment (**Span Cal**).
- Bump test the instrument before each day's use with a known concentration of each target gas. A bump test can be done in Calibration Mode's **Bump Test** item or by applying gas in Normal Mode. The instrument does not need to be calibrated unless it does not pass the User Mode bump test or does not respond appropriately, as defined by the user, in Normal Mode.
- The hydrogen response for the H₂-compensated CO sensor needs to be calibrated both monthly and when the sensor is replaced.

• Calibration Supplies and Equipment

To calibrate the EAGLE 3, the following items are required:

- Known calibrating samples of the gases being detected

Target Gas	Min. Cal. Gas Concentration	Max. Cal. Gas Concentration
Combustible Gas	1% LEL	75% LEL
Oxygen	0.0%	17.0%
Carbon Monoxide	0 ppm	2,000 ppm
Hydrogen Sulfide	1.0 ppm	200.0 ppm

NOTE: For info on calibration supplies and equipment for non-standard sensors (PID, ESF, IR, etc.), refer to the appropriate appendix.

- Demand flow regulator

WARNING: For instruments with chlorine (Cl₂) sensors, RKI Instruments, Inc. recommends using a dedicated regulator for Cl₂ gas only and not using it with any other gases, particularly hydrogen sulfide (H₂S).

- Non-absorbent tubing

NOTE: The catalytic combustible channel can be set up for and calibrated to a number of different combustible gases. See page 123 for instructions. Be sure to use an appropriate calibration cylinder for the target gas of the catalytic combustible channel.

CAUTION: When using auto calibration with the standard 4-gas EAGLE 3, although the EAGLE 3 can be calibrated with an oxygen concentration of up to 17.0%, RKI Instruments, Inc. recommends that the multi-gas cylinder have an oxygen concentration in the range of 10% - 16% oxygen.

- A 24-inch humidifier tube if you are calibrating the catalytic combustible channel with a gas concentration of 1000 ppm or lower

WARNING: *If you are using a calibration kit that includes a gas bag and a fixed flow regulator or dispensing valve, do not apply gas directly to the EAGLE 3 with the regulator or dispensing valve or damage to the pump will result. See “Appendix A: Setup Mode” on page 111 for instructions to properly use a gas bag kit.*

Performing an Air Calibration

NOTE: For calibration of CO₂ sensors, refer to “CO₂ Zero Calibration” on page 87 for zero adjustment.

NOTE: For calibration of TE sensors, refer to “Performing a TE Base Calibration” on page 88 for zero adjustment.

1. Find a fresh air environment, an environment of normal oxygen content (20.9%) that is free of toxic and combustible gases.
2. While in Calibration Mode, press **AIR** or **RANGE** to scroll to **Air Cal**.
3. Press **POWER**. The **Air Cal** screen appears with all the channel readings flashing.

♥ Cal Mode		7:49	📶	🔊
CH4 %LEL	O2	%	CO	ppm
0	20.9		0	
H2S ppm	NH3	ppm		
0.0	0.0			
Air Cal				

4. Make sure the EAGLE 3 has been turned on for at least 45 seconds before continuing.
5. Press and hold **AIR** until the screen prompts you to release it.

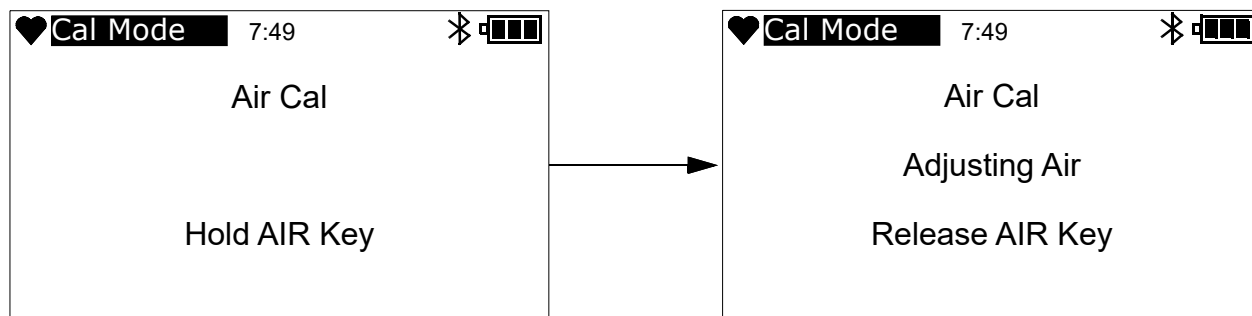

- If all channels pass the fresh air adjustment, the instrument displays a “**Pass**” message and returns to the **Cal Mode** menu.

If the fresh air adjustment fails, “**Fail**” displays for the channel(s) that failed. Press **POWER** to acknowledge the failure. See “Troubleshooting” on page 97.

Performing a Span Calibration

- Find a fresh air environment, an environment of normal oxygen content (20.9%) that is free of toxic and combustible gases.
- Install the demand flow regulator onto the calibration cylinder.
- Connect the sample tubing to the demand flow regulator.
- Install the probe on the EAGLE 3 inlet fitting. Make sure the probe is complete with internal O-ring and membrane and that the two halves of the probe are tightened firmly together to avoid leaks that can affect the calibration. See Figure 18 on page 100 for an illustration of the internal parts of the probe.
- While in Calibration Mode, press **AIR** or **RANGE** to scroll to **Span Cal**.

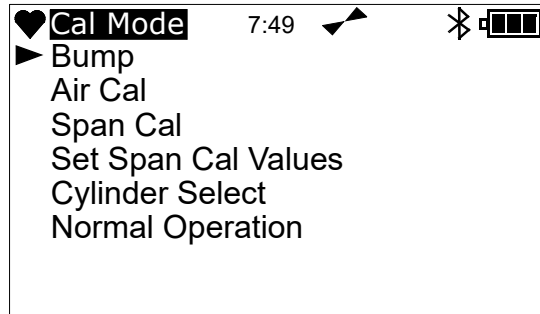

- Press **POWER**. The **Span Cal** screen shows the gases assigned to Cylinder A and their assigned calibration values (see page 93 if the calibration values do not match the calibration gas cylinder’s concentrations).

Cal Mode 7:49			
CH4 %LEL	O2 %	CO ppm	
50	12.0	50	
H2S ppm	NH3 ppm		
25.0	40.0		
Span Cal		Cylinder A	

- If necessary, press **AIR** to scroll to the **Span Cal** screen for the gas(es) you want to calibrate. As shipped from the factory, the standard 4 gases (combustible gas, O₂, CO, and H₂S) are assigned to Cylinder A.

NOTE: If an H₂-compensated CO sensor is installed, H₂ is assigned to Cylinder D. Toxic sensors are assigned to Cylinder D or Cylinder E.

8. Make sure the EAGLE 3 has been turned on for at least 45 seconds before continuing.
9. Press **POWER** and connect probe to the sample tubing.

♥ Cal Mode		7:49	📶		🔊
CH4 %LEL	O2	%	CO	ppm	
0	20.9		0		
H2S ppm	NH3	ppm			
0.0	0.0				
Span Cal		Apply Gas			

10. Allow the gas to flow and press **POWER** when the on-screen readings stabilize. Refer to the following table for gas application times.

Table 14: Calibration Gas Application Times

Target Gas	Application Time
All sensors <i>not</i> listed below	2 minutes
<ul style="list-style-type: none"> • Hydrogen Sulfide (H₂S) • Nitrogen Oxide (NO) • Nitrogen Dioxide (NO₂) 	1 minute

11. After the instrument span adjusts, it will display the calibration result. Press **POWER** to confirm.
12. If **Life Span** is on, the instrument will display the maximum and minimum spans the sensors could be adjusted to.

♥ Cal Mode		7:49	📶		🔊
CH4 %LEL	O2	%	CO	ppm	
0	20.9		0		
H2S ppm	NH3	ppm			
0.0	0.0				
Span Cal		Apply Gas			

13. If the span calibration passes, “**Pass**” appears on screen, then the instrument displays the **Life Span** and **MAX SPAN** screens for 2 seconds each.

If the span calibration fails, “**Fail**” flashes for the channel(s) that failed. Press **POWER** to acknowledge the failure and view the reading(s) that failed. See “Troubleshooting” on page 97.

Setting Span Cal Values

Use this menu to adjust the calibration values that are used during bump test and calibrations. While updating the calibration gas values in **Cal Mode** is normally done when performing a calibration, you can also update calibration values in **Setup Mode**. Updating these settings in **Setup Mode** allows you to update the settings without performing a calibration.

Target Gas	Min. Cal. Gas Concentration	Max. Cal. Gas Concentration
Combustible Gas	1% LEL	75% LEL
Oxygen	0.0%	18.0%
Carbon Monoxide	15 ppm	2,000 ppm
Hydrogen Sulfide	1.0 ppm	200.0 ppm

NOTE: For calibration concentration limits on non-standard sensors (PID, ESF, IR CO₂, etc.), refer to the appropriate appendix.

1. While in **Cal Mode**, press **AIR** or **RANGE** to scroll to **Set Span Cal Values**.
2. Press **POWER**. The channel select screen appears, displaying the first channel.

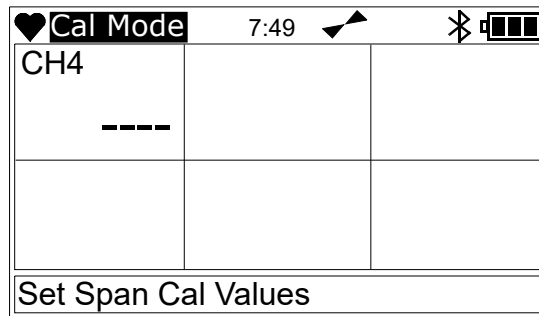

3. Press **AIR** or **RANGE** to scroll to the desired channel.
4. Press **POWER**. The channel's span cal value is displayed and begins flashing, indicating it can be adjusted.
5. Press **POWER** to adjust the channel's span cal value. The channel's current span cal value is displayed and begins flashing, indicating it can be adjusted.

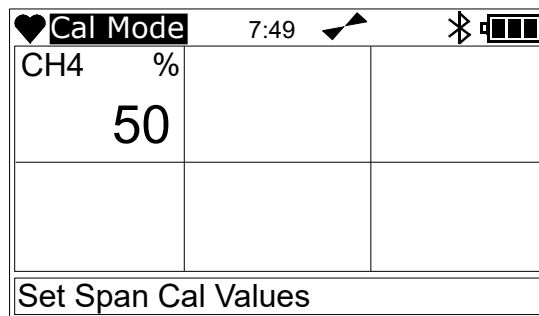

6. Use **AIR** and **RANGE** to adjust the auto calibration value to the desired value.
7. Press **POWER** button to save the value.
8. Repeat Step 3 - Step 7 for each span cal value you want to change.
If you want to return to the **Cal Mode** main menu at any time without saving any changes, press the **DISPLAY** button until you return to the main menu.
9. To exit **Set Span Cal Values**:
 - a. Press **RANGE** to scroll to **Escape**.
 - b. Press **POWER** to return to the **Cal Mode** menu.
10. To exit **Cal Mode**:
 - a. Press **AIR** or **RANGE** to scroll to **Normal Operation**.
 - b. Press **POWER** to enter Normal Mode and begin the warmup sequence.

Making Cylinder Selections

The **Cylinder Select** menu item allows you to assign calibration cylinders to each channel for calibration. As shipped from the factory, the standard 4 channels (combustible gas, O₂, H₂S, and CO) are assigned to Cylinder A.

There are 5 cylinder assignments available: **A**, **B**, **C**, **D**, and **E**. To automatically calibrate each channel separately, assign each channel to a different cylinder (ie. Cylinder A: combustible gas, Cylinder B: O₂, Cylinder C: H₂S, Cylinder D: CO).

NOTE: As shipped from the factory, the H₂ response for the H₂-compensated CO sensor is assigned to Cylinder D.

1. While in **Cal Mode**, press **AIR** or **RANGE** to scroll to **Cylinder Select**.

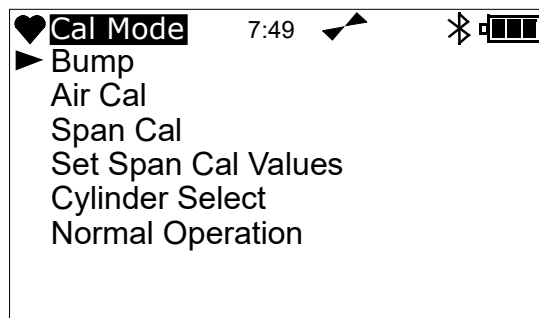

2. Press **POWER** to select the menu item. The channel selection screen appears, displaying the first channel.

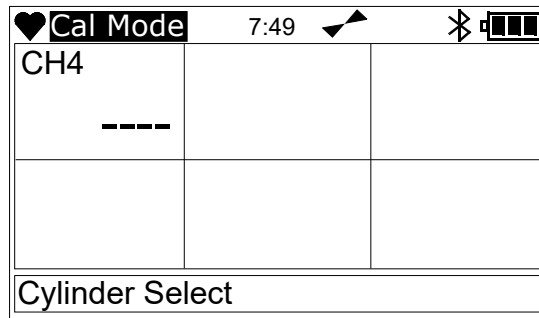

3. Press **POWER** to edit the channel's cylinder assignment. The channel's current cylinder assignment is displayed and begins flashing, indicating it can be adjusted.
4. Press **AIR** or **RANGE** to scroll between cylinder assignments **A - E**.

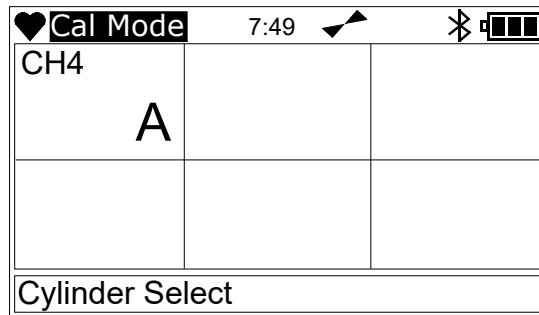

5. Press **POWER** to save the setting and return to the channel selection screen.
6. To exit **Cylinder Select**:
 - a. Press **RANGE** to scroll to **Escape**.
 - b. Press **POWER** to return to the **Cal Mode** menu.
7. To exit **Cal Mode**:
 - a. Press **AIR** or **RANGE** to scroll to **Normal Operation**.
 - b. Press **POWER** to enter Normal Mode and begin the warmup sequence.

Entering Normal Mode

The **Normal Operation** menu item allows you to return to Normal Mode if the instrument was in use before calibration or begin the warmup sequence if it was turned on just before calibration.

1. While in **Cal Mode**, press **AIR** or **RANGE** to scroll to **Normal Operation**.

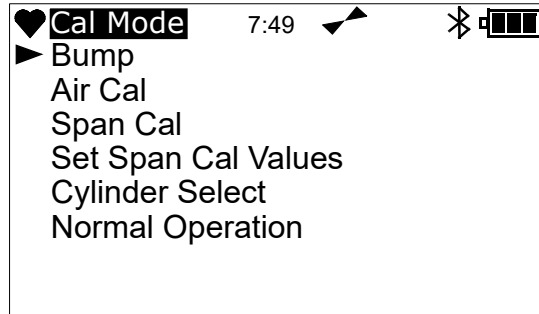

2. Press **POWER** to select the menu item. The instrument begins the warmup sequence or returns to Normal Mode if used prior to entering **Cal Mode**.

Chapter 6: Maintenance

Overview

This chapter describes troubleshooting procedures for the EAGLE 3. It also includes procedures for replacing and recharging the battery pack as well as replacing other consumable parts.

CAUTION: *After the EAGLE 3 case is opened, check that all pump tubing is securely connected and there are no kinks in the lines before securing the top case.*

WARNING: *RKI Instruments, Inc. recommends that service, calibration, and repair of RKI instruments be performed by personnel properly trained for this work. Replacing sensors and other parts with original equipment does not affect the intrinsic safety of the instrument.*

Troubleshooting

The troubleshooting table describes error messages, symptoms, probable causes, and recommended actions for problems that may arise when using the EAGLE 3.

Table 15: Troubleshooting

Symptoms	Probable Causes	Recommended Action
<ul style="list-style-type: none">The LCD is blank.	<ul style="list-style-type: none">The unit may have been turned off.The lithium-ion battery pack needs to be recharged.	<ol style="list-style-type: none">To turn on the unit, press and briefly hold POWER.If the unit does not turn on, recharge the lithium-ion battery pack.If the difficulties continue, contact RKI Instruments, Inc. for further instruction.
<ul style="list-style-type: none">The LCD shows abnormally high or low readings but other gas detection instruments do not.	<ul style="list-style-type: none">The EAGLE 3 may need to be recalibrated.The sensor for the affected channel(s) may need replacement.	<ol style="list-style-type: none">Recalibrate the unit.If the difficulties continue, replace the sensor for the affected channel(s) and calibrate the affected channel(s).If the difficulties continue, contact RKI Instruments, Inc. for further instruction.

Table 15: Troubleshooting

Symptoms	Probable Causes	Recommended Action
<ul style="list-style-type: none"> • The unit indicates flow failure and does not recover when POWER is pressed. 	<ul style="list-style-type: none"> • The probe tube is clogged. • The hydrophobic filter disk in the probe is dirty. • The sample hose has a kink or obstruction. • The internal hydrophobic filter is dirty. • The pump is malfunctioning. 	<ol style="list-style-type: none"> 1. Inspect the probe tube for any obstructions. 2. Inspect the hydrophobic filter disk in the probe and replace if necessary. 3. Inspect the sample hose for kinks or obstructions and replace if necessary. 4. Inspect the internal hydrophobic filter and replace if necessary. 5. If difficulties continue, contact RKI Instruments, Inc. for further instruction.
<ul style="list-style-type: none"> • Span Calibration fails. 	<ul style="list-style-type: none"> • The calibration values may not match the cylinder gas concentrations (auto calibration only). • The charcoal filter is saturated causing an elevated CO reading. • The sample gas is not reaching the sensors because of a bad connection. • The calibration cylinder may be out of gas or is outdated. • The sensor for the affected channel(s) may need replacement. 	<ol style="list-style-type: none"> 1. Check all calibration tubing for leaks or for any bad connections. 2. Make sure the EAGLE 3 has been properly set up for calibration. 3. Change the charcoal filter. 4. Verify that the calibration cylinder contains an adequate supply of fresh test sample. 5. If the fail condition continues, replace the sensor(s). 6. If the difficulties continue, contact RKI Instruments, Inc. for further instruction.
<ul style="list-style-type: none"> • The catalytic channel's zero reading does not remain stable. 	<ul style="list-style-type: none"> • The instrument or sensor may have been damaged by a strong impact. 	<ol style="list-style-type: none"> 1. Perform a zero air adjustment in a fresh air environment.

Recharging the EAGLE 3

WARNING: *To prevent ignition of a hazardous atmosphere, batteries must only be charged in an area known to be nonhazardous.*

Be sure to use the dedicated AC adapter for charging.

Charge the battery at an ambient temperature between 0°C and 40°C.

CAUTION: *Do not use the product while charging. Doing so will decrease performance and accuracy. This will also increase battery degradation and reduce battery life.*

The AC adapter is neither waterproof nor dustproof. Do not charge the battery pack while the unit is wet.

The AC adapter is not explosion-proof.

Do not short-circuit the connection terminals with metal objects. The battery will overheat or battery levels will drop sharply.

NOTE: When turning on the product for the first time or if the battery level is low, be sure to charge the battery using the dedicated AC charger.

NOTE: The lithium ion battery pack may get hot during charging. This is not an abnormality.

Wait at least 10 minutes before use. The instrument will be hot immediately after charging. Using the lithium ion battery while it is still hot may decrease reading accuracy.

The battery cannot be recharged when fully charged.

Charge the battery pack when the EAGLE 3 indicates that it is in low battery warning. When in low battery warning, the battery icon will appear empty and start flashing.

CAUTION: *Use with Li-ion battery p/n 49-1631. Charge only with RKI charger model 49-0142. Use of other rechargeable batteries or chargers or charging of other rechargeable batteries in the EAGLE 3 will void the warranty.*

1. Plug the power adapter into an AC outlet.
2. Make sure the EAGLE 3 is off.
3. Make sure the adapter and module are connected.

4. Insert and slide the power connector along the grooves of the EAGLE 3's external charging contacts located on the right side of the bottom case.
5. While the battery pack is charging, the LED indicator will be red.
6. A full charge should be reached in less than 11.5 hours. When a full charge has been reached, the LED indicator will be green.

Replacing the Hydrophobic Probe's Hydrophobic Filter Disk

Inspect the probe's internal components if you notice that the EAGLE 3's pump sounds bogged down or if an unexplained low flow alarm occurs. Replace the hydrophobic filter disk if it appears dirty or saturated with liquid. Replace the O-rings in the probe if either of them appears damaged. Frequency of replacement will depend on the operating conditions.

1. Grasp each end of the clear probe body firmly and unscrew the two halves from each other. One half includes a plastic tube fitting and the probe tube. The other half includes a metal fitting that mates with the EAGLE 3 inlet fitting.

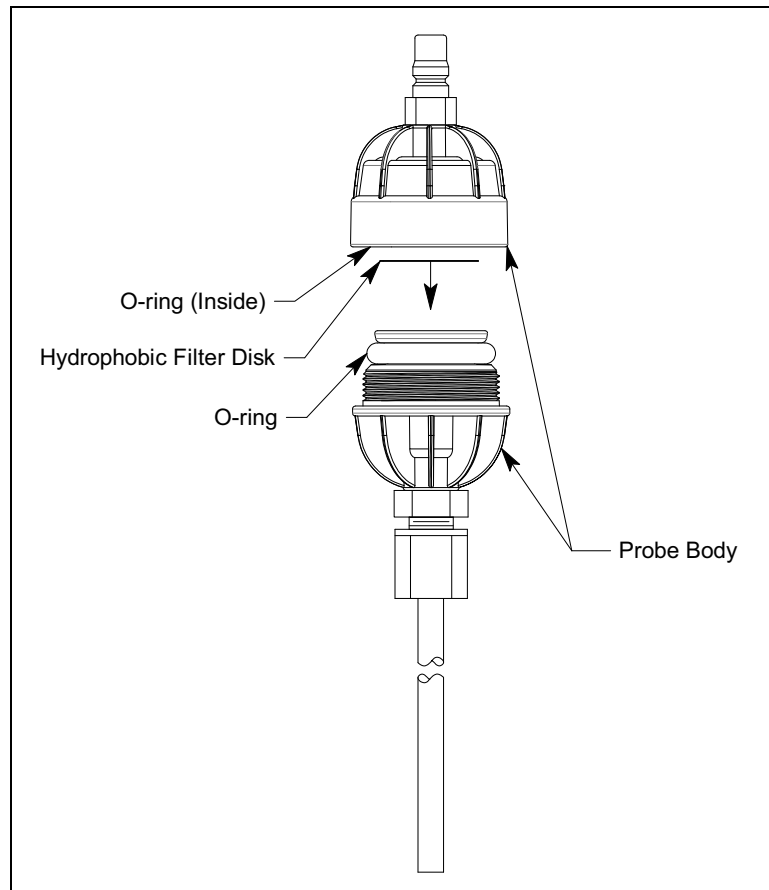

Figure 18: Replacing the Probe's Filters

2. Remove the white hydrophobic filter disk from the probe body.

3. Clean the inside of the probe body if necessary.
4. Hold the probe half that has the plastic tube fitting and the probe tube with the fitting and tube facing down.
5. Place the new filter disk flat on top of the probe body. Make sure it is centered.
6. Carefully screw the other half of the probe body onto the half with the filter disk while keeping the probe oriented vertically to keep the disk centered.
7. When you feel the O-ring being compressed, grasp both ends of the probe and tighten them together very firmly to ensure a seal.

Testing the Probe Filter Seal

To test the probe's seal, do the following:

1. Install the probe on the EAGLE 3.
2. Warmup the EAGLE 3.
3. Confirm that a low flow alarm occurs when you cover the end of the probe tube with your finger.
4. If a low flow alarm does not occur, hand tighten the probe further.

If a low flow alarm still does not occur when you cover the probe tube with your finger, disassemble the probe, inspect the placement of the O-rings and filter disk, reassemble the probe, and re-test it.

Replacing the Hydrophobic Filter

Replace the hydrophobic filter inside the bottom case when it becomes dirty or clogged. An unexplained low flow alarm may indicate that the hydrophobic filter is dirty and needs to be replaced. Frequency of replacement will depend on the operating conditions.

CAUTION: *After the EAGLE 3 case is opened, check that all pump tubing is securely connected and there are no kinks in the lines before securing the top case.*

1. Verify that the EAGLE 3 is off.
2. Place the EAGLE 3 upside down on a flat surface or hold it upside down.
3. Unscrew the three case screws until they disengage from the top case. They are captive screws so they will not fall off of the bottom case.
4. Turn the EAGLE 3 right side up and carefully lift the top case away from the bottom case. Be careful not to lift it so far that it pulls on the main PCB with the cable that connects the top case to the main PCB.
5. Lay the top case down next to the bottom case to allow access to the flow system.

6. Locate the hydrophobic filter. It is next to the pump and LEL sensor.

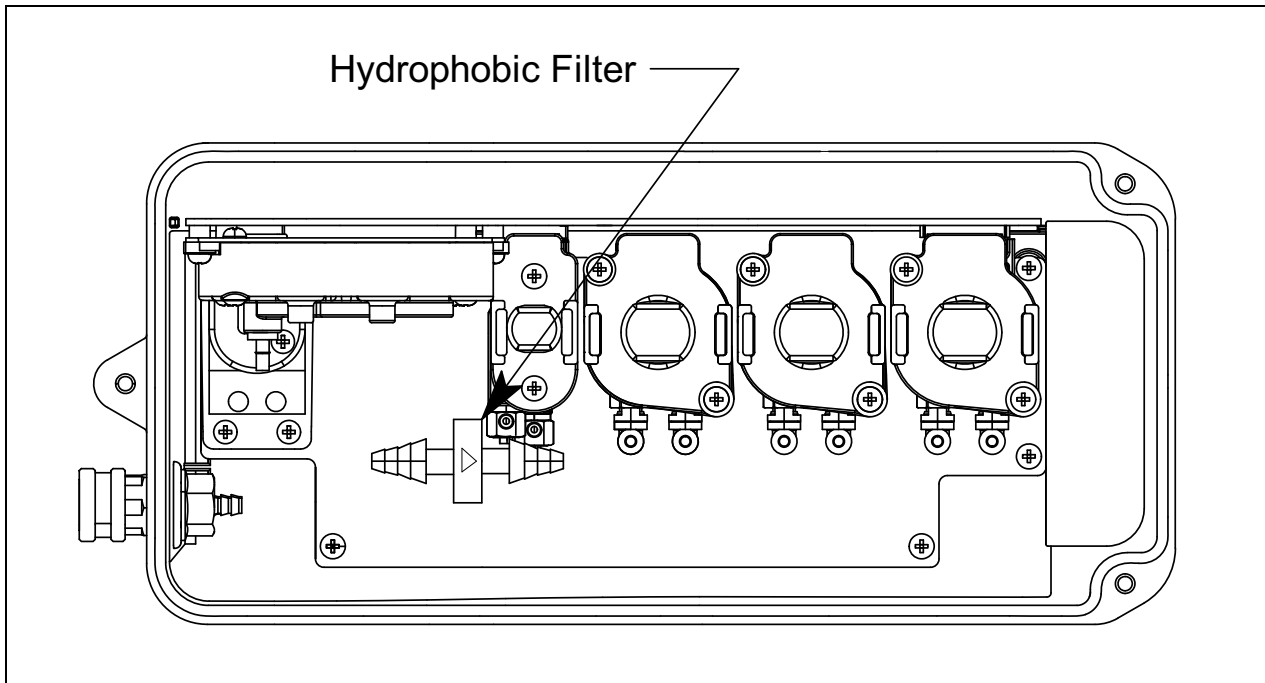

Figure 19: Replacing the Hydrophobic Filter

7. Pull the gray connecting tubes off of each end of the filter and remove it.
8. Install the new filter with the triangle on the side of the filter facing the BACK of the EAGLE 3, away from the inlet fitting. Make sure to push the gray connection tubes all the way onto the filter's hose barbs.
9. Confirm that the main PCB is seated in its slots and that its bottom edge is resting on the bottom of the bottom case. If the main PCB is not seated properly, then it may be damaged when the top case is re-installed.
10. Ensure that all internal tubing is connected without any pinched lines.
11. Make sure that the gasket along the edge of the bottom case is fully seated in its groove and carefully put the top case back on the bottom case. If you have any difficulty mating the top and bottom cases, inspect the placement of the main PCB and the placement of the bottom case gasket.
12. Turn the EAGLE 3 upside down and tighten the three case screws to secure the top case to the bottom case. Screws should be tightened to a torque of at least 30 N/cm.

Replacing the Sensor Filters

CAUTION: *The sensors and filters are the only user-serviceable parts in the EAGLE 3. Do not replace or modify any other part.*

CAUTION: *After the EAGLE 3 case is opened, check that all pump tubing is securely connected and there are no kinks in the lines before securing the top case.*

CO Sensor Filter

A black charcoal filter is installed over the CO sensor. The filter should be replaced if you notice unexplained CO readings or every 6 months.

H₂S Sensor Filter

A white humidity filter is installed over the H₂S sensor. The filter absorbs humidity in the sampling environment to prevent unstable readings around 0 ppm H₂S. For users with a 1 ppm H₂S alarm setpoint, the filter should be replaced if you notice: a drift on the H₂S channel's zero reading, unexplained H₂S readings, the filter appears dirty, or every 6 months (whichever is sooner). For users with a 2 ppm or higher H₂S alarm setpoint, the filter does not necessarily ever need to be replaced.

Replacement Procedure

1. Verify that the EAGLE 3 is off.
2. Turn the EAGLE 3 upside down.
3. Use a small Phillips screwdriver to unscrew the three captive screws holding the bottom case to the top case.
4. Turn the EAGLE 3 right side up and gently lift the top case from the rest of the instrument. Lay the top case down next to the bottom case to allow access to the flow system.
5. Locate the R sensor flow chamber mounted on the main PCB.
6. Unscrew the flow chamber's four screws and gently pull away from the main PCB.
7. Gently pry out the filter you want to replace.
8. Install the new filters.
 - a. Black filter for CO sensor: The red side of the filter case should face toward the sensor.
 - b. White filter for H₂S sensor: The white side of the filter case should face toward the sensor.
9. Screw the flow chamber screws into the main PCB.
10. Ensure that all internal tubing is connected without any pinched lines.

11. Place the top case back over the bottom case and screw the case screws. Screws should be tightened to a torque of at least 30 N/cm.
12. Perform a bump test as described on page 80 to confirm good operation.

Checking the Combustible Gas Sensor's Condition

If you suspect that the combustible sensor has been contaminated or may be reaching the end of its operational life, do the following to confirm it is still operating properly:

1. Perform a calibration on the combustible gas sensor's channel as described in "Performing a Calibration" on page 87.
2. When performing a span adjustment, note the adjustment range on the result screen as described in Step 12 on page 92.
3. A new sensor can typically be adjusted to more than twice the calibration gas concentration. If the result screen indicates that the EAGLE 3 could not adjust the combustible gas reading to be at least 10% higher than the calibration gas concentration, then the sensor should be replaced as soon as possible.

Sensor Replacement

CAUTION: *After the EAGLE 3 case is opened, check that all pump tubing is securely connected and there are no kinks in the lines before securing the top case.*

The recommend replacement interval for the Transformer version's oxygen sensor is 2 years. The recommended replacement interval for all other sensors is 3 years.

Replacing an O₂, CO, H₂S, and LEL Sensor

1. Verify that the EAGLE 3 is off.
2. Place the EAGLE 3 upside down on a flat surface or hold it upside down.
3. Unscrew the three case screws until they disengage from the top case. They are captive screws so they will not fall off of the bottom case.
4. Turn the EAGLE 3 right side up and carefully lift the top case away from the bottom case. Be careful not to lift it so far that it pulls on the main PCB with the cable that connects the top case to the main PCB.
5. Lay the top case down next to the bottom case to allow access to the flow system.

6. Locate the sensor you want to replace.

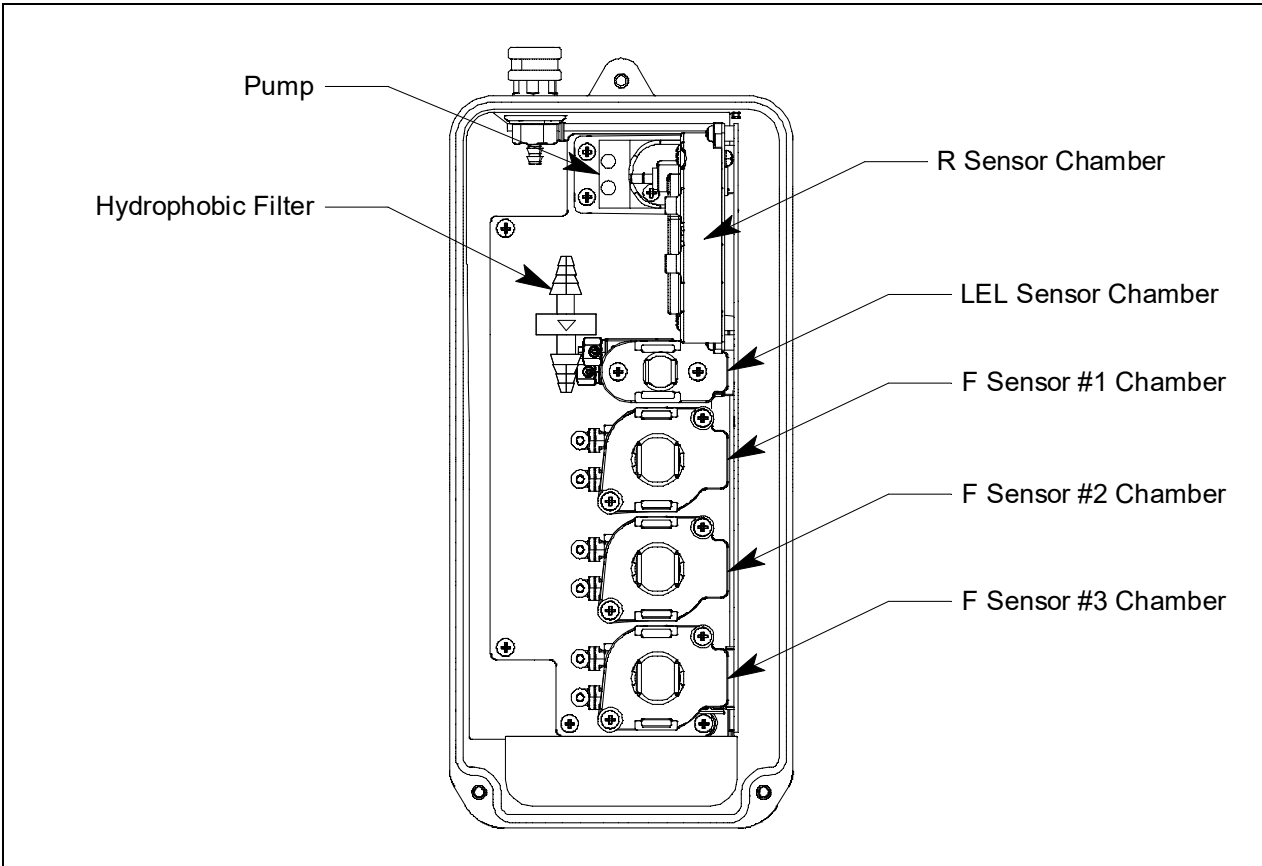

Figure 20: Sensor Location

7. For O₂, CO, and H₂S sensors:
- Locate the R sensor flow chamber at the top of the main PCB.
 - Unscrew the 4 screws holding the flow chamber down.
 - Remove the filter gasket.

- d. Remove the sensor(s) you want to replace.
- e. Install the new sensor(s).
- f. Reinstall the filter gasket and screw the flow chamber back onto the main PCB.

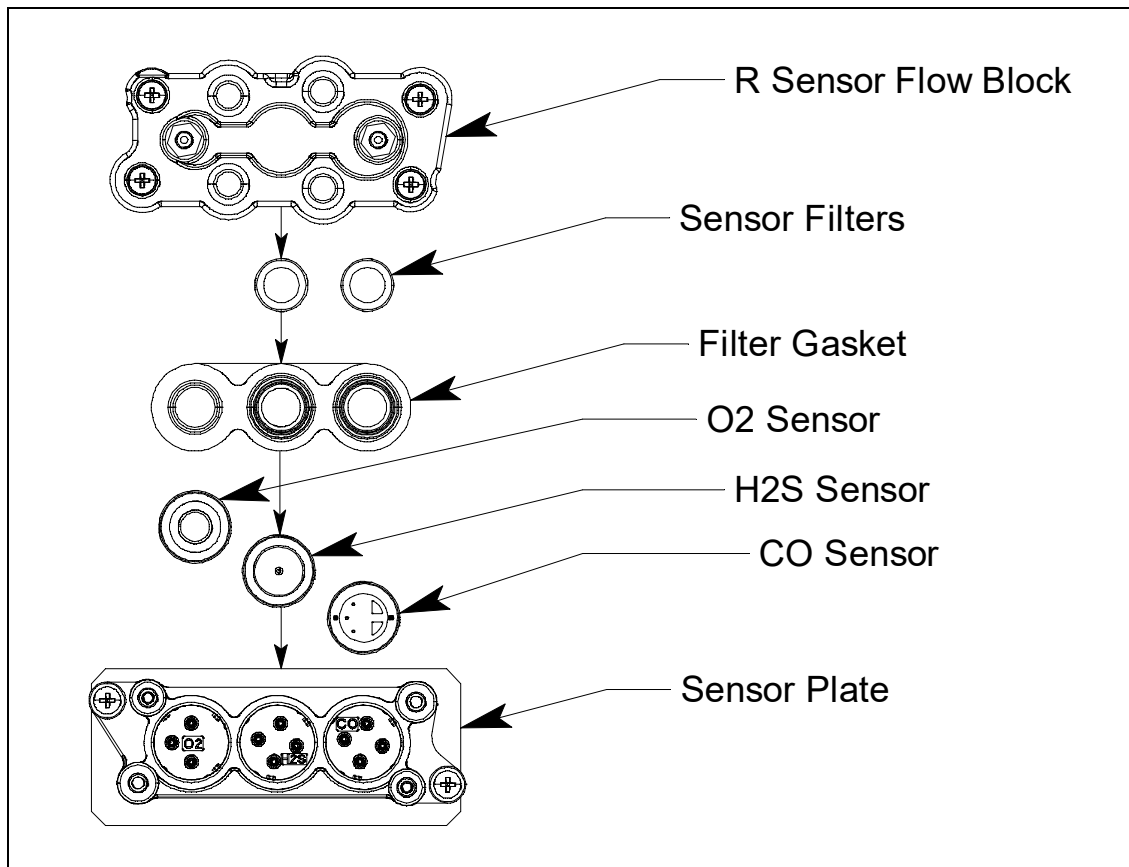

Figure 21: Replacing an R Sensor

8. For the LEL Sensor:
 - a. Unscrew and remove the two screws that hold down the LEL sensor retainer.
 - b. Grasp the retainer and gently pull it up until the LEL sensor comes out of the flow chamber with the retainer/adapter PCB.
 - c. Pull the old sensor off the adapter PCB.
 - d. Plug the replacement sensor into the LEL sensor adapter PCB/retainer.
 - e. Insert the LEL sensor and sensor adapter PCB into the LEL sensor chamber in the flow chamber, making sure to align the teeth of the sensor adapter PCB to the connector on the main PCB.
 - f. Line up the holes in the LEL sensor retainer with the two standoffs on either side of the LEL sensor chamber.
 - g. Screw the two sensor retainer screws by alternately tightening them to push the sensor into its chamber and connector evenly.

9. Confirm that the main PCB is seated in its slots and that its bottom edge is resting on the bottom of the bottom case. If the main PCB is not seated properly, then it may be damaged when the top case is re-installed.
10. Ensure that all internal tubing is connected without any pinched lines.
11. Make sure that the case gasket along the edge of the bottom case is fully seated in its groove and carefully put the top case back on the bottom case. If you have any difficulty mating the top and bottom cases, inspect the placement of the main PCB and the placement of the bottom case gasket.
12. Turn the EAGLE 3 upside down and tighten the three case screws to secure the top case to the bottom case. Screws should be tightened to a torque of at least 30 N/cm.
13. Calibrate the new sensors as described in “Chapter 5: Calibration Mode” on page 79.

Replacing F-Sensors

- For PID sensors, see “Replacing the PID Sensor” on page 209.
- For ESF sensors, see “Replacing the ESF Sensor or Changing Sensor Type” on page 216.
- For TC sensors, see “Replacing the TC Sensor” on page 221.
- For IR CO₂ sensors, see “Replacing the IR CO₂ Sensor or Changing Sensor Type” on page 229.
- For IR CH₄ sensors, see “Replacing the IR Methane Sensor” on page 235.
- For IR hydrocarbon sensors, see “Replacing the IR Hydrocarbon Sensor” on page 241.

Cleaning the EAGLE 3

- Before cleaning the instrument, be sure to turn off the power and use a damp rag or cloth.
- Do not clean using water, organic solvents, or commercially available cleaners for cleaning the EAGLE 3 as these can cause the product to malfunction.

CAUTION: *When wiping the product clean, ensure that water does not splash on it and do not use organic solvents like alcohol or benzene. These may discolor or damage the case or cause sensors to malfunction.*

Chapter 7: Storage and Disposal

Storage

- Store away from direct sunlight
- Store in a location with normal temperature and humidity
- Store in a location free of gases, solvents, and vapors
- Store away from dust and dirt
- The instrument must always be stored with a battery pack that is fully charged. The sensors use a small amount of power even when the instrument is turned off. It is important to recharge the battery pack every 6 months during storage.
 - If the battery pack has been completely drained (the unit does not power on), instruments with NH₃ sensors require 2 hours for sensor warmup before turning the instrument on for normal operation.
 - If the EAGLE 3 completely loses power during storage, the date/time must be reset as described on page 118.

	Storage Time While Off
Fully charged	2 years
Low battery alarm	1 week

Disposal

- Remove the battery pack
- Dispose in accordance with local regulations

Chapter 8: General Parts List

Table 16: General Parts List

Part Number	Description
06-1248RK-03	Calibration kit tubing, 3 foot length
07-7210RK	O-ring for inlet fitting half of probe
07-7304RK	O-ring for tube half of probe
	Panel screw, captive, 6-32 x 1/2 inch, for bottom case
30-0600RK-01	Pump
33-0156RK-01	Filter element, hydrophobic disk, for standard 80-0131RK-10 probe, pack of 5
33-2002RK-01	Humidifier, 24 inch, for calibration of catalytic combustible channel with gas concentrations of 1000 ppm or lower
33-7132	Charcoal filter for CO sensor, 5 pack
33-7133	Humidity filter for H ₂ S sensor, 5 pack
49-0142	AC adapter
49-1631	Li-ion battery pack
61-0155-01	LEL combustible sensor, catalytic, H ₂ -specific
65-7004	Dummy sensor, CO, H ₂ S, and O ₂ sensor position
65-7005	Dummy sensor for PIF, ESF, IRF, TEF sensors
71-0590	<i>EAGLE 3 Operator's Manual</i> (this document)
80-0131RK-20	10-inch hydrophobic probe (standard probe)
80-0132RK-10	10-inch hydrophobic probe (for super-toxic gases)
80-0133RK-10	30-inch aluminum probe
80-0134RK-10	4-foot stainless steel hydrophobic probe
80-0135RK-10	30-inch stainless steel hydrophobic probe
80-0136RK	32-inch telescoping fiberglass probe w/dust filter
80-0137RK	10-inch probe w/dust filter
80-0143RK	7-foot telescoping fiberglass probe w/dust filter
80-0156RK-10	30-inch fiberglass hydrophobic probe
80-0160RK-12	12-foot extendable probe
80-0160RK-18	18-foot extendable probe
80-0405RK	Dilution fitting, 1:1
80-0406RK	Dilution fitting, 3:1

Table 16: General Parts List

Part Number	Description
80-05XXRK	Sample hose, replace “XX” with length in feet (5-foot hose is standard), available lengths for the EAGLE 3 are 3, 4, 5, 6, 10, 15, 20, 25, 30, 35, 40, 50, 75, 100, and 125 feet.
81-0090RK-01	Calibration cylinder, 34 liter steel, three-gas (CH ₄ /O ₂ /CO)
81-0090RK-03	Calibration cylinder, 103 liter, three-gas (CH ₄ /O ₂ /CO)
81-0154RK-02	Calibration cylinder, 58 liter; four-gas (CH ₄ /O ₂ / H ₂ S/CO)
81-0154RK-04	Calibration cylinder, 34 liter aluminum; four-gas (CH ₄ /O ₂ / H ₂ S/CO)
81-1054RK	Regulator, demand-flow type, for 34 liter aluminum/58 liter/103 liter calibration cylinders (cylinders with internal threads)
81-1055RK	Regulator, demand-flow type, for 17 liter and 34 liter steel calibration cylinders (cylinders with external threads)
81-5302RK	Calibration kit, for LEL/O ₂ /CO unit, w/demand flow regulator, 103 liter cylinder
81-5401RK	Calibration kit, for LEL/O ₂ /H ₂ S/CO unit, w/demand flow regulator, 58 liter cylinder
ESR-A13i-H2S	H ₂ S sensor
ESR-A13P-CO	CO sensor
ESR-A1CP-CO	CO (H ₂ -compensated) sensor
ESR-X13P-OXY	O ₂ sensor
NC-6260B	LEL combustible sensor, catalytic

Appendix A: Setup Mode

Overview

The EAGLE 3 is factory-set to suit most applications. Update settings in Setup Mode only if required for a specific application. The description of each item below indicates the factory setting for each item.

Setup Mode Menu Item	Description	
Set Date/Time (page 118)	Set the current date and time.	
Set Date Format (page 119)	<ul style="list-style-type: none"> • MM/DD/YYYY (factory setting): month/day/year • YYYY/MM/DD: year/month/day • DD/MM/YYYY: day/month/year 	
Configure Channels (page 121)	Select which sensor corresponds to each channel.	
Configure Gases (page 123)	Select the target gas for each sensor.	
Catalytic Units (page 125)	<ul style="list-style-type: none"> • %LEL Only: Only show combustible readings in %LEL • vol% Only: Only show combustible readings in volume • ppm Only: Only show combustible readings in ppm • Change OK (factory setting): allows for switching between LEL, vol, and ppm by using the RANGE SHIFT button 	
LEL Standard (page 126)	<ul style="list-style-type: none"> • Standard (factory setting): Apply standard settings for the LEL's ppm level. • IEC: Apply IEC settings for the LEL's ppm level. • ISO: Apply ISO settings for the LEL's ppm level. 	
Relative Response (page 127)	<ul style="list-style-type: none"> • On (factory setting): The Relative Response screen appears in Display Mode. See page 64 for information about this feature. • Off: The Relative Response screen does not appear in Display Mode. 	
Alarm Settings (page 128)	Alarm Points (page 128)	Update one or more alarm points. See Table 1 for alarm point factory settings.
	Alarm Latching (page 131)	<ul style="list-style-type: none"> • Enabled (factory setting): The EAGLE 3 remains in alarm condition until the alarm condition passes and the RESET button is pressed. • Disabled: The EAGLE 3 automatically resets an alarm when the alarm condition passes.
	Buzzer Silence (page 132)	<ul style="list-style-type: none"> • On (factory setting): During an alarm condition, pressing the RESET button silences the buzzer. • Off: During an alarm condition, the buzzer cannot be silenced and the LEDs will continue to flash.

Setup Mode Menu Item		Description
Alarm Settings (page 128) cont.	Sensor Life Alert (page 133)	<ul style="list-style-type: none"> • On: Enable several indicators for sensors that are nearing expiration. • Off (factory setting): Disable sensor expiration indicators.
	Save User Alarm (page 134)	Save all current, user-set alarm settings.
	Restore User Alarm (page 135)	Restore all current alarm settings to the user adjusted settings.
	Restore 4 Gas Alarm (page 136)	Restore the current alarm settings to the 4-gas alarm settings.
	Restore Fact. Alarm (page 137)	Restore all current alarm settings to the factory default alarm settings.
	Escape	Return to the Setup Mode menu.
User and Station ID (page 138)		<ul style="list-style-type: none"> • On (factory setting): The User ID and Station ID screens appear in startup sequence. IDs can be selected in Display Mode. See page 69 and page 70 for information about this feature. • Off: The User ID and Station ID screens do not appear in startup sequence. IDs cannot be selected in Display Mode.
Demand Zero (page 139)		<ul style="list-style-type: none"> • On (factory setting): Fresh air adjustments can be performed while in Normal Mode by pressing AIR. • Off: Fresh air adjustments cannot be performed while in Normal Mode.
Auto Zero (page 140)		<ul style="list-style-type: none"> • On: The option to perform a fresh air adjustment appears at the end of the startup sequence. • Off (factory setting): The option to perform a fresh air adjustment does not appear at the end of the startup sequence.
CO2 Air Zero (page 141)		<ul style="list-style-type: none"> • On: The CO₂ channel is set to 400 ppm (0.04% volume) during a demand zero, auto zero, or Air Calibration. • Off (factory setting): The CO₂ channel is not adjusted during a demand zero, auto zero, or Air Calibration.
Data Log Settings (page 142)	Data Log Interval (page 142)	Select how often the EAGLE 3 saves readings to the data logger. The following interval times can be selected: Options: 10 minutes, 5 minutes (factory setting), 3 minutes, 2 minutes, 1 minute, 30 seconds, 20 seconds, or 10 seconds
	Data Log Overwrite (page 143)	<ul style="list-style-type: none"> • On (factory setting): The EAGLE 3 writes over the oldest data with new data when the data logger memory is full. • Off: The EAGLE 3 stops saving data to the data logger when the data logger memory is full.
	Escape	Return to the Setup Mode menu.

Setup Mode Menu Item	Description	
Backlight Time (page 144)	This parameter controls how long the back light stays on after the most recent button press. Options: 0 seconds, 5 seconds, 10 seconds, 20 seconds, 30 seconds (factory setting), 1 minute, 3 minutes, 5 minutes , 10 minutes	
LCD Contrast (page 145)	Increasing the contrast darkens the characters and LCD background. Option: 1 - 50 (factory setting is 20)	
Key Tone (page 146)	<ul style="list-style-type: none"> • On (factory setting): The instrument will beep every time a button is pressed. • Off: The instrument will not beep when a button is pressed but will still beep during an alarm condition. 	
Calibration Settings (page 147)	Cal Reminder (page 147)	<ul style="list-style-type: none"> • On (factory setting): The EAGLE 3 will give an indication at start up if it is due for calibration. The type of indication will depend on the Calibration Past Due Reminder setting. • Off: The EAGLE 3 will not give an indication at start up if it is due for calibration.
	Cal Past Due Act (page 148)	Select what action is taken if a calibration is due upon startup. <ul style="list-style-type: none"> • Confirm to Use (factory setting): Press DISPLAY to acknowledge that a calibration is past due and continue to Normal Mode. • Cannot Use: Cannot enter Normal Mode until a successful calibration is performed. • No Effect: A screen indicates that a calibration is past due but the warmup sequence continues.
	Cal Interval (page 149)	Define the amount of time between calibrations. Options: 0 - 365 days (factory setting is 90 days)
	Sensor Life Span (page 150)	<ul style="list-style-type: none"> • Enabled: After a passed calibration, the EAGLE 3 displays the maximum possible adjustment it could have made to the response reading. • Disabled (factory setting): There is no maximum span indication at the end of a calibration.
	Cal Auto Start (page 150)	<ul style="list-style-type: none"> • On: The instrument automatically begins the warmup sequence after passing calibration. • Off: The instrument remains in Calibration Mode after passing calibration.
	Escape	Return to the Setup Mode menu.

Setup Mode Menu Item	Description	
Bump Settings (page 151)	Bump Reminder (page 151)	<ul style="list-style-type: none"> • On: The instrument notifies the user upon startup when a bump test is due. The notification type depends on Bump Past Due Reminder setting. • Off (factory setting): No notification upon startup when a bump test is due.
	Bump Past Due Act (page 153)	Define what action must be taken if a bump test is due upon startup. <ul style="list-style-type: none"> • Confirm to Use (factory setting): Press DISPLAY to acknowledge that a bump test is past due and continue to Normal Mode. • Cannot Use: Cannot enter Normal Mode until a successful bump test is performed. • No Effect: A screen indicates that a bump test is past due but the warmup sequence continues.
	Bump Interval (page 154)	Define the amount of time between bump tests. Options: 0 - 60 days (factory setting is 30 days)
	Bump Auto Start (page 155)	<ul style="list-style-type: none"> • On: The instrument automatically enters begins the warmup sequence after passing a bump test. • Off: The instrument remains in Calibration Mode after a bump test passes.
	Gas Time (page 156)	Define how long gas is applied during a bump test. Options: 30 (factory setting), 45, 60, 90 seconds
	Tolerance (page 157)	Percentage of calibration gas concentration that the bump test reading must be within in order to pass bump Options: 10%, 20%, 30%, 40%, and 50% (factory setting)
	Cal Time (page 158)	Define how long gas is applied for auto calibration if the bump test fails. The Gas Time setting is deducted from this time. Options: 90 (factory setting) and 120 seconds
	Auto Cal (page 158)	<ul style="list-style-type: none"> • On (factory setting): If a bump test fails, the unit will automatically begin a calibration. • Off: If a bump test fails, a calibration does not automatically start.
	Escape	Return to the Setup Mode menu
Gas Test (page 160)	Test sensor response and observe alarm indications without an alarm event being recorded.	
Sensor Date (page 161)	View and/or set the battery and sensor replacement dates.	

Setup Mode Menu Item		Description
Mode Select (page 162)		<ul style="list-style-type: none"> • Off (factory setting): The Mode Select Screen does not appear when the unit is turned on, and the unit goes into Normal Mode after the start up sequence. • Leak Check Only: The Mode Select Screen appears when the unit is turned on. The available options are Normal Mode and Leak Check Mode. • Bar Hole Only: The Mode Select Screen appears when the unit is turned on. The available options are Normal Mode and Bar Hole Mode. • Leak & Bar Hole: The Mode Select Screen appears when the unit is turned on. The available options are Normal Mode, Leak Check Mode, and Bar Hole Mode. • Inert: The Mode Select Screen appears when the unit is turned on. The available options are Normal Mode and Inert Mode.
Bar Hole Time (page 163)		This setting indicates the length of time the unit will sample when a bar hole measurement is initiated in Bar Hole Mode. Options: 30 (factory setting), 45, and 60 seconds
CO Display In Leak Check (page 164)		<ul style="list-style-type: none"> • Off (factory setting): The CO channel is not displayed in Leak Check Mode. This setting has no effect on Normal Mode. • On: The CO channel will be displayed in Leak Check Mode, but there will be no CO alarms. If any snap logs are taken, the CO reading can only be viewed using the EAGLE 3 Datalogging Program.
Zero Follower (page 165)		Not intended for field adjustment. Oxygen channel does not support zero follower functionality. Factory setting for all other channels is On .
Zero Suppression (page 168)		<p>On (factory setting): Not intended for field adjustment. The following are the suppression values:</p> <ul style="list-style-type: none"> • Combustible gas: 2% LEL • O2: 0.5% volume • H2S: 0.3 ppm • CO: 2 ppm • CO2: 0 ppm • HCN: 0.5 ppm • NH3: 10 ppm • NO2: 0.30 ppm • PH3: 0.02 ppm • SO2: 0.20 ppm
Confirmation Alert (page 170)	Beep Select (page 170)	<ul style="list-style-type: none"> • Off (factory setting): The EAGLE 3 does not sound a confirmation alert. • LED: The EAGLE 3 flashes the LED arrays after a user-defined period to verify that it is operating.

Setup Mode Menu Item	Description
Confirmation Alert (page 170) cont.	<div data-bbox="393 199 678 856"> <p>Beep Select (page 170) cont.</p> </div> <ul style="list-style-type: none"> • Buzzer: The EAGLE 3 beeps after a user-defined period to verify that it is operating. • LED and Buzzer: The EAGLE 3 beeps and flashes the LED arrays after a user-defined period to verify that it is operating. • Bump/Cal: If a bump test or a calibration is due and Bump/Cal Past Due Act is set to Confirm to Use or No Effect, the EAGLE 3's LEDs flash as often as defined by the Beep Interval parameter to indicate a non-compliance. Once a successful bump test or calibration (depending on which is due) is done, the LEDs stop flashing. • Alarm Alert: If the instrument goes into any gas alarm, the LEDs flash as often as defined by the Beep Interval parameter to indicate a non-compliance. Once a successful bump test or calibration is done, the LEDs stop flashing. • Bump/Cal/Alarm: The LEDs flash to indicate a non-compliance if a bump test/calibration is due and Bump/Cal Past Due Act is set to Confirm to Use or No Effect, or if the instrument goes into any gas alarm. <div data-bbox="393 865 678 1018"> <p>Beep Interval (page 172)</p> </div> <p>Select the amount of time between each confirmation alert. Options: 5 seconds, 10 seconds, 20 seconds, 30 seconds, 1 minute, 3 minutes, 5 minutes (factory setting), 10 minutes, 20 minutes, 30 minutes</p> <div data-bbox="393 1026 678 1066"> <p>Escape</p> </div> <p>Return to the Setup Mode menu.</p>
Stealth (page 170)	<ul style="list-style-type: none"> • On: The backlight, LED, and buzzer are disabled regardless of alarm conditions or Backlight Time settings. • Off (factory setting): The backlight, LED, and buzzer operate normally.
Lunch Break (page 174)	<ul style="list-style-type: none"> • On: At startup, the instrument allows the user to resume TWA and PEAK readings from the last time it was used. • Off (factory setting): The instrument resets TWA and PEAK readings every time it is turned on.
Language (page 175)	<p>View/change the instrument language. Options: English</p>
Calibration Mode Password (page 176)	<ul style="list-style-type: none"> • On: A password is required to enter Calibration Mode. The factory set password is 0006. • Off (factory setting): No password is required to enter Calibration Mode.
Setup Password (page 177)	<ul style="list-style-type: none"> • On: A password is required to enter Setup Mode. The factory set password is 0000. • Off (factory setting): No password is required to enter Setup Mode.

Setup Mode Menu Item	Description
Low Flow Fail Calibration (page 178)	This calibration is performed if an instrument repeatedly goes into low flow alarm and all of the recommendations in “Troubleshooting” on page 97 have been followed.
Software Version (page 180)	View the firmware information for the EAGLE 3’s sensor boards, main board, gas list, and Bluetooth version.
Radio Standard (page 181)	View the IC and FCC ID standards.
Save User Configuration (page 138)	Save all current User Configurations.
Restore User Configuration (page 138)	Restore the User Configuration to its factory defaults.
Restore Four Gas Defaults (page 184)	Restore all Four Gas settings to their factory defaults.
Restore Factory Defaults (page 186)	Restore all settings to their factory defaults.
Normal Operation (page 187)	Begin the warmup sequence and enter Normal Mode.

Tips for Using Setup Mode

- When in the main menu, the cursor (▶) points to the first menu item.
- Press **RANGE** to move the cursor down through the menus, to decrease values, or to change the setting in a specific option.
- Press **AIR** to move the cursor up through the main menu and submenu items, to raise values, or change the setting in a specific option.
- Flashing parameters can be adjusted by pressing **AIR** or **RANGE**. Holding either button down increases scroll speed.
- Press **POWER** to enter the menu the cursor is pointing to or to save a selected setting and return to the Setup Mode menu.
- Press **DISPLAY** while in a settings menu to exit the screen without saving any changes.

Entering Setup Mode

WARNING: *The EAGLE 3 is not in operation as a gas detector while in Setup Mode.*

1. Take the EAGLE 3 to a non-hazardous location and turn it off if it is on.
2. Press and hold **AIR** and **RANGE**, then press and hold **POWER**. When you hear a beep, release both buttons.
3. The screen that appears depends on the **Setup Password** setting in Setup Mode.
If **Setup Password** is set to **On** (factory setting), continue with Step 4.
If **Setup Password** is set to **Off**, continue with Step 6.

- If **Setup Password** is set to **On**, a password screen appears. The factory-set password is **0000**, but it can be changed if desired.

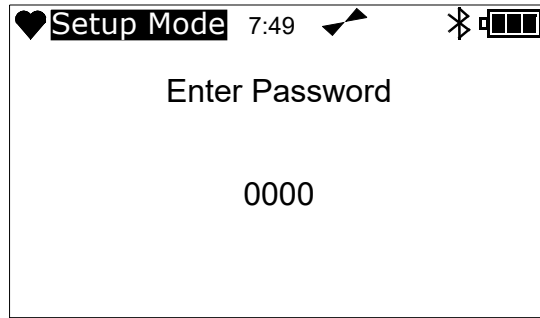

- Press **AIR** to select each password number then press **POWER** to save it and move to the next number.
To return to a previous digit, press and release **DISPLAY**.
- The Setup Mode menu appears. Press **AIR** or **RANGE** to move the cursor up or down and to view additional menu items.

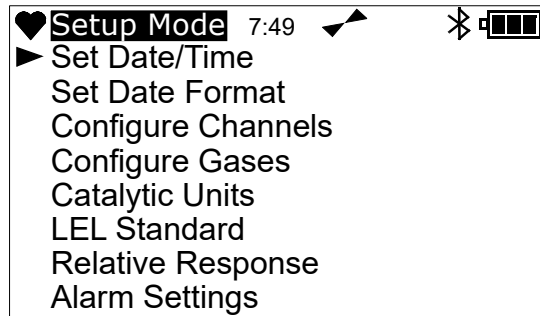

- Press **POWER** to select the desired menu item.
- To exit Setup Mode:
 - Press **AIR** or **RANGE** to scroll to **Normal Operation**.
 - Press **POWER** to enter Normal Mode and begin the warmup sequence.

Setting the Date and Time (Set Date/Time)

- While in Setup Mode, press **AIR** or **RANGE** to scroll to **Set Date/Time**.

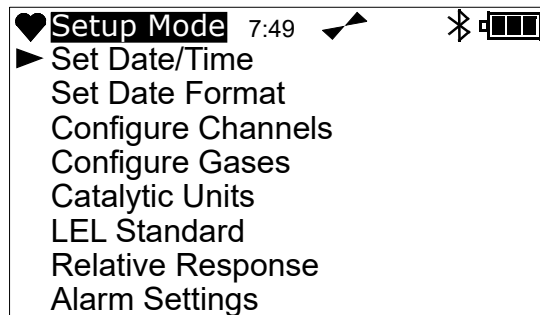

2. Press **POWER** to select the menu item. The **Set Date/Time** screen appears with the year value flashing.

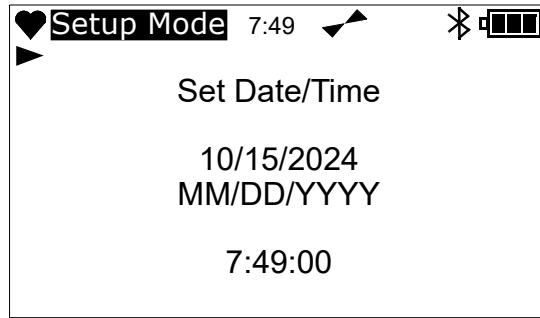

3. Press **AIR** or **RANGE** to scroll to the desired value.
4. Press **POWER** to enter the setting and move to the next value.
5. Repeat Step 3 to enter the month, day, hours, minutes, and seconds values. After the seconds value has been entered, the unit returns to the Setup Mode menu.
6. To exit Setup Mode:
 - a. Press **AIR** or **RANGE** to scroll to **Normal Operation**.
 - b. Press **POWER** to enter Normal Mode and begin the warmup sequence.

Setting the Date Format (Set Date Format)

Use this menu to select one of the following date formats:

- **MM/DD/YYYY** (factory setting)
- **YYYY/MM/DD**
- **DD/MM/YYYY**

1. While in Setup Mode, press **AIR** or **RANGE** to scroll to **Set Date Format**.

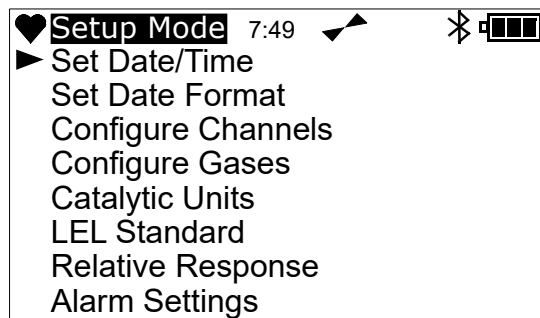

2. Press **POWER** to select the menu item. The **Set Date Format** screen appears with the cursor next to the current setting.

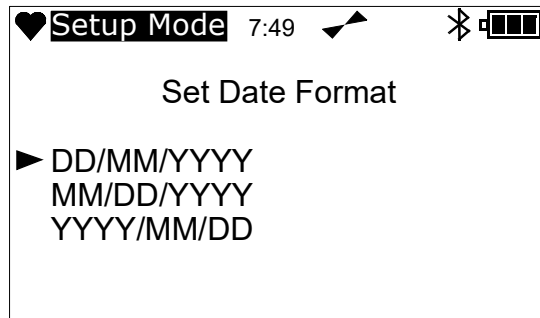

3. Press **AIR** or **RANGE** to scroll to the desired setting.
4. Press **POWER** to save the setting and return to the Setup Mode menu.
5. To exit Setup Mode:
 - a. Press **AIR** or **RANGE** to scroll to **Normal Operation**.
 - b. Press **POWER** to enter Normal Mode and begin the warmup sequence.

Configuring the Channels (Configure Channels)

Use this menu to change the order that channels are displayed on the LCD during normal operation. The following figure shows a standard EAGLE 3 with 4 channels (4 reading slots) in this order (left to right, top to bottom): combustible gas (catalytic sensor), oxygen, CO, and H₂S (channels 5 and 6 are turned off).

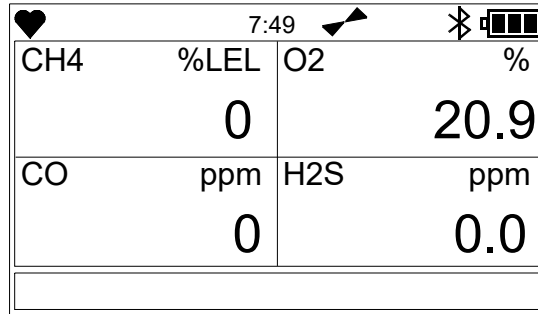

♥ 7:49		📶 🔊	
CH4	%LEL	O2	%
	0		20.9
CO	ppm	H2S	ppm
	0		0.0

NOTE: An EAGLE 3 can have 2 more sensors installed and formatted to have any desired gas displayed in Normal Operation. The following example is for an EAGLE 3 with 6 channels (6 available reading slots).

1. While in Setup Mode, press **AIR** or **RANGE** to scroll to **Configure Channels**.

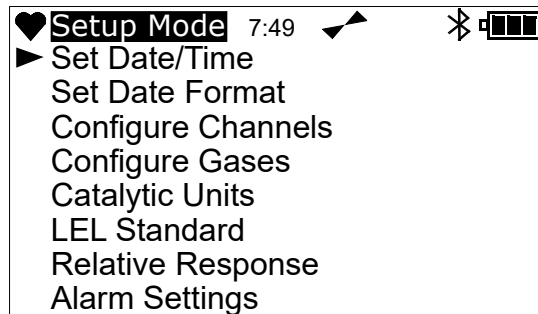

♥ Setup Mode 7:49	📶 🔊
▶ Set Date/Time	
Set Date Format	
Configure Channels	
Configure Gases	
Catalytic Units	
LEL Standard	
Relative Response	
Alarm Settings	

2. Press **POWER** to select the menu item. The **Configure Channels** screen appears with the first reading slot's assigned sensor displayed in the top left corner of the screen.

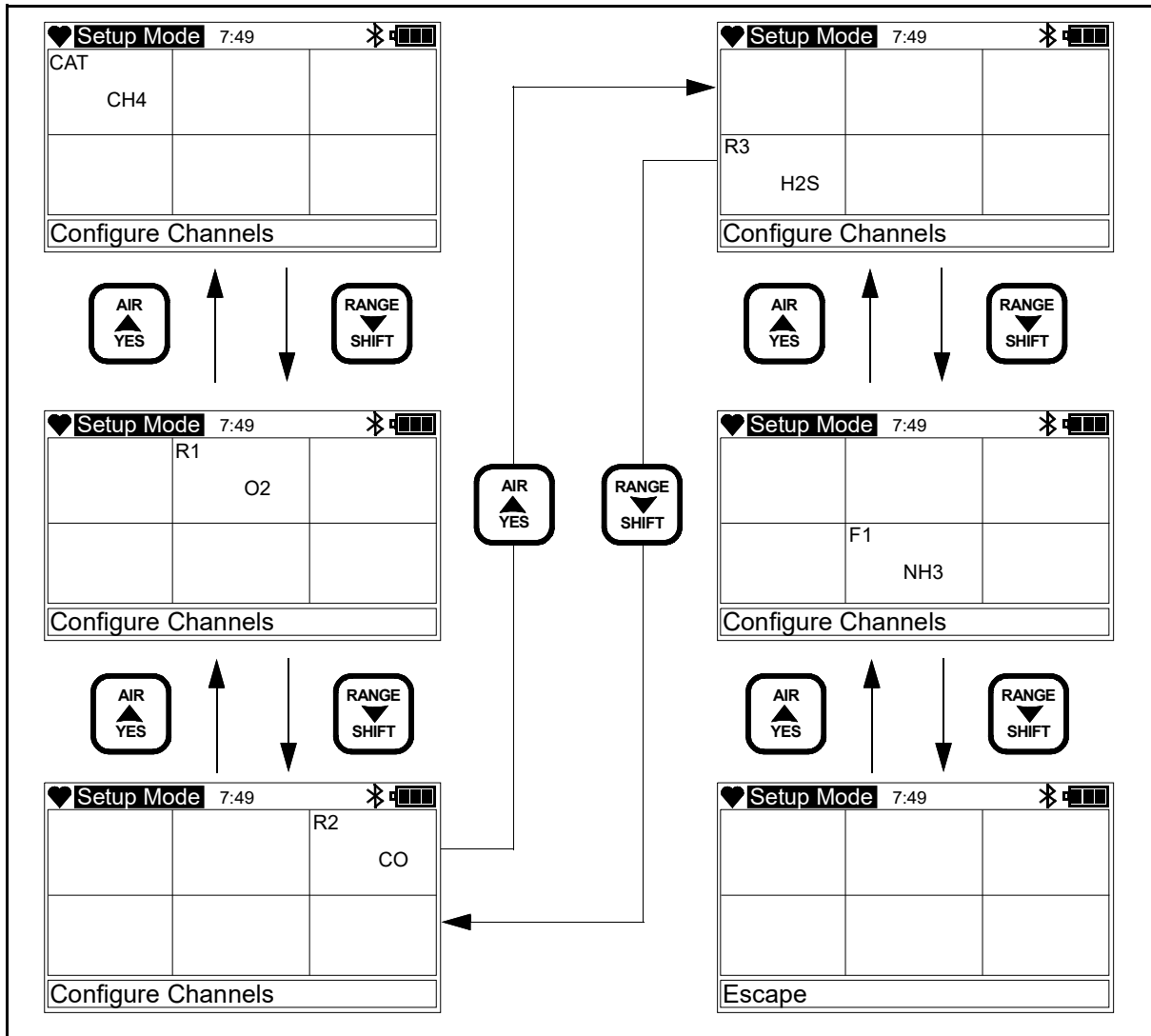

3. Press **RANGE** to scroll to the reading slot that should be changed.
4. Press **POWER** to edit the gas assigned to the reading slot. The assigned gas flashes, indicating it can be changed.

NOTE: The F1, F2, and F3 options are not defined in a standard 4-gas EAGLE 3. These options are only defined when F-sensors are installed.

5. Press **AIR** or **RANGE** until the desired sensor/gas appears.
6. Press **POWER** to save assignment.
7. Press **RANGE** to move to the next reading slot. Press **AIR** to move to the previous slot. Repeat Step 2 through Step 5 for all other reading slots if desired.

8. To return to the Setup Mode menu:
 - a. Press **RANGE** until the **Escape** screen appears.
 - b. Press **POWER** to select the menu item.
9. To exit Setup Mode:
 - a. Press **AIR** or **RANGE** to scroll to **Normal Operation**.
 - b. Press **POWER** to enter Normal Mode and begin the warmup sequence.

Configuring the Gases (Configure Gases)

Use this menu to configure catalytic, TC (thermal conductivity), or PID (photo ionization detector) sensors. In a standard EAGLE 3, only the catalytic sensor can be configured. PID or TC sensors can only be configured if those sensors are installed.

For each of the catalytic sensor's gas choices, the LEL (lower explosive limit) and gas name are displayed. The LEL is shown in terms of ppm. The available choices are on two screens.

Some catalytic channel gas choices have pre-defined settings for methane elimination. See "Adjusting the Methane Elimination Mode" on page 63 for a description of the Methane Elimination Mode screen in Display Mode. See Appendix I: Methane Elimination Mode for a description of Methane Elimination Mode.

WARNING: *Do not configure the catalytic sensor gas to hydrogen when monitoring for general hydrocarbons. Only use this configuration when monitoring exclusively for hydrogen or to prevent a significant response to other combustible gases.*

1. While in Setup Mode, press **AIR** or **RANGE** to scroll to **Configure Gases**.

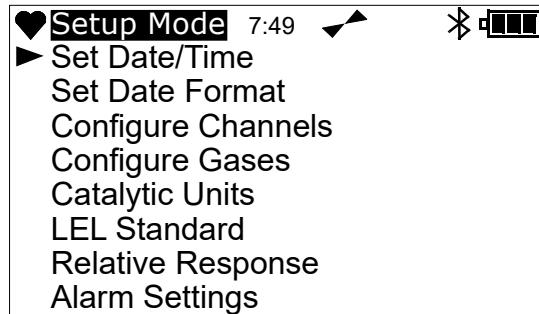

2. Press **POWER** to select the menu item. The **Configure Gases** screen appears with the catalytic channel's setting displayed, indicating that it can be adjusted.

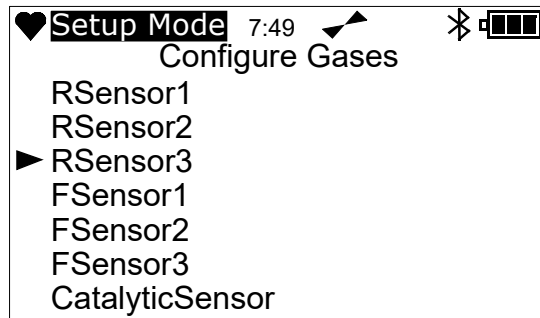

3. Press **AIR** or **RANGE** to scroll to the desired channel.
 - To adjust the **CAT** channel, press **POWER** to select the channel and proceed to “Adjusting Target Gas for Catalytic Sensors”.
 - To adjust a non-**CAT** channel, press **POWER** to select the channel and proceed to “Adjusting Channels for Non-Catalytic Sensors” on page 125.

Adjusting Target Gas for Catalytic Sensors

1. After selecting the catalytic sensor's channel, the **Catalytic Configure Gases** screen appears. Press **AIR** or **RANGE** to scroll to the desired gas.

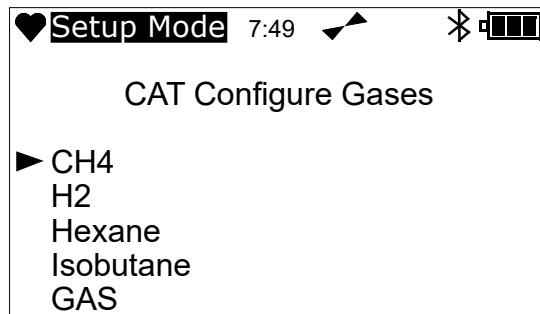

2. Press **POWER** to select the desired gas.
3. Press **POWER** to save the desired value and return to the **Configure Gases** screen.
4. To exit the **Configure Gases** screen:
 - a. Press **RANGE** to scroll to **Escape**.
 - b. Press **POWER** to return to the Setup Mode menu.
5. To exit Setup Mode:
 - a. Press **AIR** or **RANGE** to scroll to **Normal Operation**.
 - b. Press **POWER** to enter Normal Mode and begin the warmup sequence.

Adjusting Channels for Non-Catalytic Sensors

1. After selecting a non-catalytic sensor's channel from the **Configure Gases** screen, the channel's **Configure Gases** screen appears with the cursor next to the current setting.

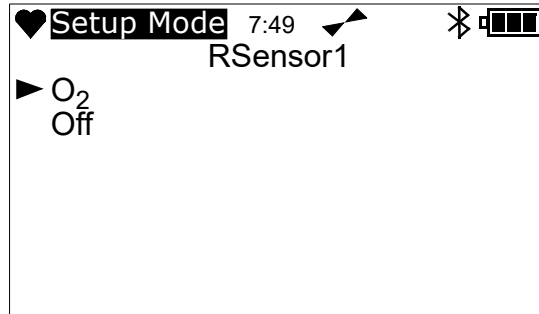

2. Press **AIR** or **RANGE** to scroll to the desired setting.
3. Press **POWER** to save the desired setting and return to the **Configure Gases** screen.
4. To exit the **Configure Gases** screen:
 - a. Press **RANGE** to scroll to **Escape**.
 - b. Press **POWER** to enter Normal Mode and begin the warmup sequence.
5. To exit Setup Mode:
 - a. Press **AIR** or **RANGE** to scroll to **Normal Operation**.
 - b. Press **POWER** to enter Normal Mode and begin the warmup sequence.

Selecting the Catalytic Detection Units (Catalytic Units)

Use this menu to select one of the following measurement units for the catalytic sensor channel: **%LEL Only**, **vol% Only**, **ppm Only**, and **Change OK** (factory setting).

Change OK allows units to be manually changed while in Normal Mode by pressing **RANGE**.

1. While in Setup Mode, press **AIR** or **RANGE** to scroll to **Catalytic Units**.
2. Press **POWER** to select the menu item. The **Catalytic Units** screen appears with the cursor next to the current setting.

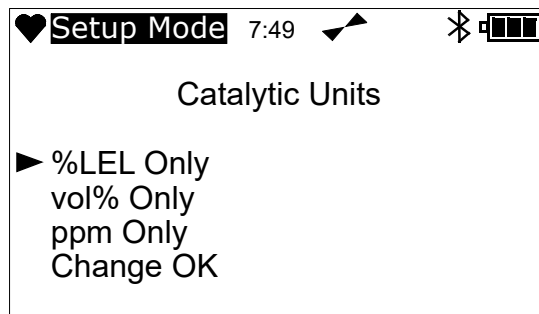

3. Press **AIR** or **RANGE** to scroll to the desired setting.
4. Press **POWER** to save the setting and return to the Setup Mode menu.
5. To exit Setup Mode:
 - a. Press **AIR** or **RANGE** to scroll to **Normal Operation**.
 - b. Press **POWER** to enter Normal Mode and begin the warmup sequence.

Selecting the LEL Standard

Use this menu to select one of the following standards that the instrument uses to determine the LEL (lower explosive limit) for the combustible channel's target gas.

- **Standard** (factory setting) applies the standard settings for the lower explosive limit's ppm level
 - **IEC** applies the IEC settings (per IEC 60079-20-1 2010[ed1.0]) for the lower explosive limit's ppm level.
 - **ISO** applies the ISO settings (per ISO 10156 2017) for the lower explosive limit's ppm level.
1. While in Setup Mode, press **AIR** or **RANGE** to scroll to **LEL Standard**.

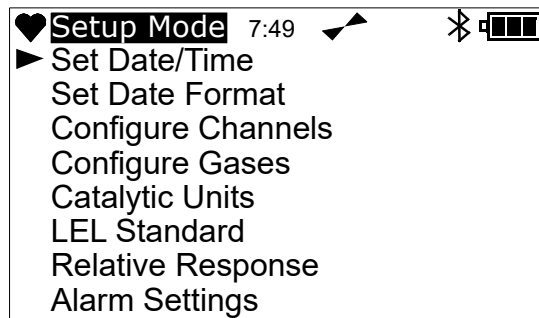

2. Press **POWER** to select the menu item. The **LEL Standard** screen appears with the cursor next to the current setting.

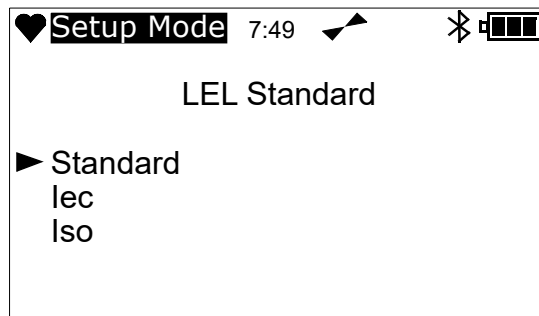

3. Press **AIR** or **RANGE** to scroll to the desired setting.
4. Press **POWER** to save the setting and return to the Setup Mode menu.

5. To exit Setup Mode:
 - a. Press **AIR** or **RANGE** to scroll to **Normal Operation**.
 - b. Press **POWER** to enter Normal Mode and begin the warmup sequence.

Turning the Catalytic Sensor Relative Response On or Off (Relative Response)

The relative response feature allows the catalytic sensor's response to be changed on the fly so that the catalytic channel is roughly calibrated to an alternate gas.

If the catalytic channel is setup for and calibrated to methane, another combustible gas can be selected from the gas list accessible from the **Catalytic Sensor Relative Response** in Display Mode (if the **Relative Response** setting is **On**). The channel will then respond to gas as if it were calibrated to the selected gas. For more information about using this feature, see page 64.

1. While in Setup Mode, press **AIR** or **RANGE** to scroll to **Relative Response**.

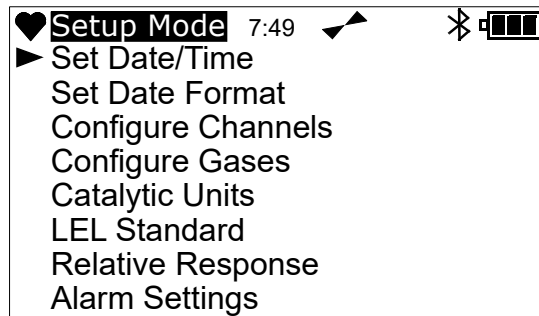

2. Press **POWER** to select the menu item. The **Relative Response** screen appears with the cursor next to the current setting.

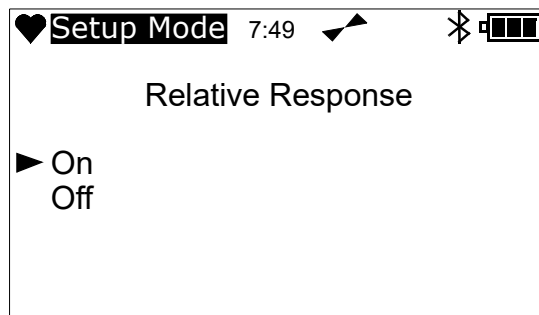

3. Press **AIR** or **RANGE** to scroll to the desired setting.
4. Press **POWER** to save the setting and return to the Setup Mode menu.
5. To exit Setup Mode:
 - a. Press **AIR** or **RANGE** to scroll to **Normal Operation**.
 - b. Press **POWER** to enter Normal Mode and begin the warmup sequence.

Updating the Alarm Settings

Changing Alarm Points

Use this menu to update one or more alarm points (the reading at which the EAGLE 3 recognizes the alarm condition).

Table 17: Alarm Point Ranges

Channel	Alarm Point Limitations
Combustible Gas	5% LEL ≤ Alarm 1 ≤ Alarm 2 ≤ 60% LEL (0% - 113%)
Oxygen (O ₂)	<ul style="list-style-type: none"> • 0.0% ≤ Alarm L ≤ 21.8% • 20.0% ≤ Alarm H ≤ 40.0%
Hydrogen Sulfide (H ₂ S)	1.0 ppm ≤ Alarm 1 ≤ Alarm 2 ≤ 200.0 (100) ppm
Carbon Monoxide (CO)	15 ppm ≤ Alarm 1 ≤ Alarm 2 ≤ 2000 (500) ppm
Carbon Dioxide (CO ₂)	All ranges: 0 ≤ Alarm 1 ≤ Alarm 2 ≤ full scale
Ammonia (NH ₃)	4.5 ppm ≤ Alarm 1 ≤ Alarm 2 ≤ 75.0 ppm
Hydrogen Cyanide (HCN)	0.9 ppm ≤ Alarm 1 ≤ Alarm 2 ≤ 15.0 ppm
Nitrogen Dioxide (NO ₂)	0.9 ppm ≤ Alarm 1 ≤ Alarm 2 ≤ 15.0 ppm
Phosphine (PH ₃)	0.06 ppm ≤ Alarm 1 ≤ Alarm 2 ≤ 1.00 ppm
Sulfur Dioxide (SO ₂)	0.35 ppm ≤ Alarm 1 ≤ Alarm 2 ≤ 6.00 ppm
Silane (SiH ₄)	0.9 ppm ≤ Alarm 1 ≤ Alarm 2 ≤ 15.0 ppm
Disilane (Si ₂ H ₆)	0.9 ppm ≤ Alarm 1 ≤ Alarm 2 ≤ 15.0 ppm
Nitric Oxide (NO)	6 ppm ≤ Alarm 1 ≤ Alarm 2 ≤ 100 ppm
Hydrogen Bromide (HBr)	0.35 ppm ≤ Alarm 1 ≤ Alarm 2 ≤ 6.00 ppm
Hydrogen Chloride (HCl)	0.35 ppm ≤ Alarm 1 ≤ Alarm 2 ≤ 6.00 ppm
Fluorine (F ₂)	0.18 ppm ≤ Alarm 1 ≤ Alarm 2 ≤ 3.00 ppm
Hydrogen Fluoride (HF)	0.09 ppm ≤ Alarm 1 ≤ Alarm 2 ≤ 1.50 ppm
Ozone (O ₃)	0.035 ppm ≤ Alarm 1 ≤ Alarm 2 ≤ 0.600 ppm
Chlorine Trifluoride (ClF ₂)	0.018 ppm ≤ Alarm 1 ≤ Alarm 2 ≤ 0.300 ppm
Chlorine (Cl ₂)	0.09 ppm ≤ Alarm 1 ≤ Alarm 2 ≤ 1.50 ppm
PIDs	All ranges: 0 ≤ Alarm 1 ≤ Alarm 2 ≤ full scale
TEF	1.0 ≤ Alarm 1 ≤ Alarm 2 ≤ 100.0

Table 17: Alarm Point Ranges

Channel	Alarm Point Limitations
Combustible IRF sensors	$0 \leq \text{Alarm 1} \leq \text{Alarm 2} \leq 100\% \text{ max}$

When setting the alarm points, keep the following in mind:

- The low alarm cannot be set higher than the high alarm, and the high alarm cannot be set lower than the low alarm.
- In addition to setting the oxygen alarm points, you can also select one of the following operation modes: low alarm decreasing and high alarm increasing (**L-H**); low and high alarm decreasing (**L-L**); low and high alarm increasing (**H-H**). The factory setting is **L-H**.

1. While in Setup Mode, press **AIR** or **RANGE** to scroll to **Alarm Settings**.

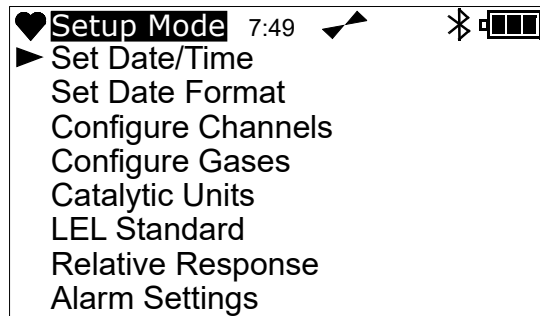

2. Press **POWER** to select the menu item. The **Alarm Settings** menu appears.

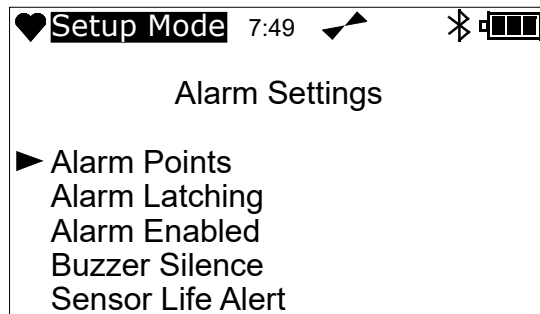

3. Press **AIR** or **RANGE** to scroll to **Alarm Points**.

4. Press **POWER** to select the menu item. The **Alarm Points** screen appears, displaying the first channel.

5. Press **AIR** or **RANGE** to scroll to the desired channel.

6. Press **POWER** to select the desired channel and begin editing the **Alarm 1** setting.

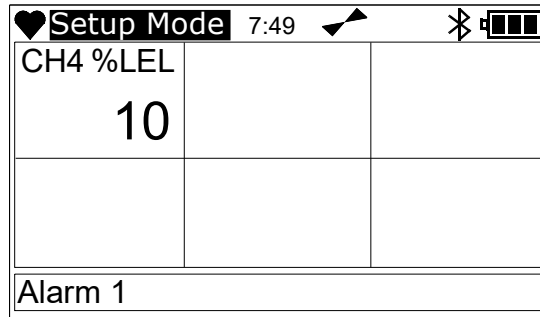

7. Press **AIR** or **RANGE** to scroll to the desired value.

8. Press **POWER** to confirm and repeat Step 7 for the **Alarm 2** setting.

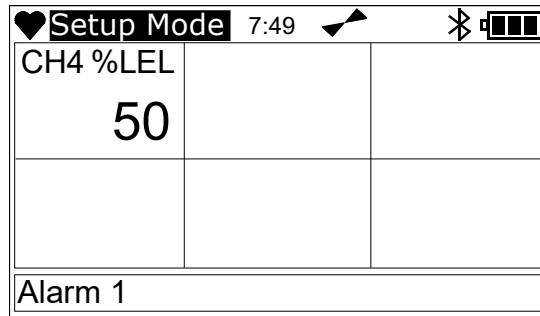

9. Press **POWER** to confirm and move to the next alarm setting. Refer to the following table for the alarm settings of each channel type:

Catalytic Channel	<ul style="list-style-type: none"> • Alarm 1 (%LEL) • Alarm 2 (%LEL) • Alarm 1 ppm • Alarm 2 ppm 	<ul style="list-style-type: none"> • Alarm 1 %vol • Alarm 2 %vol • Alarm 1 ME (Methane Elimination, ppm) • Alarm 2 ME (ppm) 	<ul style="list-style-type: none"> • Alarm 1 ME LEL • Alarm 2 ME LEL • Alarm 1 ME VOL • Alarm 2 ME VOL
Toxic Gas Channels	<ul style="list-style-type: none"> • Alarm 1 • Alarm 2 • STEL • TWA 		
O₂ Channel	<ul style="list-style-type: none"> • Alarm 1 • Alarm 2 <p><u>Alarm Types:</u></p> <ul style="list-style-type: none"> • L-H (factory setting): Alarm 1 decreasing, Alarm 2 increasing • L-L: Both alarms decreasing • H-H: Both alarms increasing 		

10. When all settings for a channel have been saved, the instrument returns to the **Alarm Points** screen. Press **RANGE** to move to the next channel. Press **AIR** to move to the previous channel.

11. To return to the Alarm Settings menu:
 - a. Press **RANGE** until the **Escape** screen appears
 - b. Press **POWER** to select the menu item.
12. To return to the Setup Mode menu:
 - a. Press **AIR** or **RANGE** to scroll to the **Escape** menu item.
 - b. Press **POWER** to select the menu item.
13. To exit Setup Mode:
 - a. Press **AIR** or **RANGE** to scroll to **Normal Operation**.
 - b. Press **POWER** to enter Normal Mode and begin the warmup sequence.

Changing the Alarm Latching Setting

Enabled (factory setting): The instrument remains in alarm condition until the alarm condition passes and **POWER** is pressed.

Disabled: The instrument automatically resets an alarm when the alarm condition passes.

1. While in Setup Mode, press **AIR** or **RANGE** to scroll to **Alarm Settings**.
2. Press **POWER** to select the menu item. The **Alarm Settings** menu appears.
3. Press **AIR** or **RANGE** to scroll to **Alarm Latching**.
4. Press **POWER** to select the menu item. The **Alarm Latching** menu appears with the cursor next to the current setting.

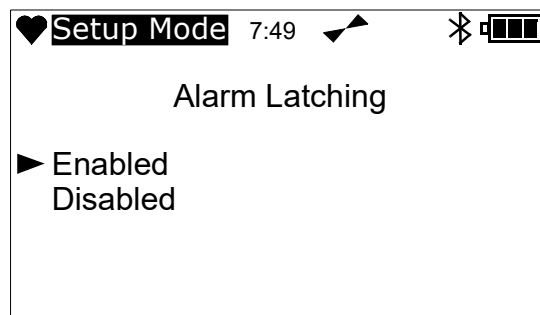

5. Press **AIR** or **RANGE** to scroll to the desired setting.
6. Press **POWER** to save the setting and return to the Alarm Settings menu.
7. To return to the Setup Mode menu:
 - a. Press **AIR** or **RANGE** to scroll to the **Escape** menu item.
 - b. Press **POWER** to select the menu item.
8. To exit Setup Mode:
 - a. Press **AIR** or **RANGE** to scroll to **Normal Operation**.
 - b. Press **POWER** to enter Normal Mode and begin the warmup sequence.

Turning the Buzzer Silence Setting On or Off

On (factory setting): Pressing and releasing any button silences the buzzer when the EAGLE 3 is in alarm. The LEDs continue to flash and the display continues to show the alarm.

- When the gas concentration falls below the alarm level, pressing and releasing **POWER** clears all alarm indicators for that alarm.
- To enter Display Mode during an alarm condition, press **DISPLAY**. The buzzer will be silenced, but the LEDs will continue to flash.
- If you return to Normal Mode and there is still an alarm condition, the LEDs will continue to flash and the buzzer will remain off. Once the condition clears, press **POWER** to clear the alarm indicators.

Off: The buzzer cannot be silenced. If an alarm condition occurs, and you enter Display Mode, the buzzer will not be silenced and the LEDs will continue to flash. Upon returning to Normal Mode, if there is still an alarm condition, you must wait until it clears before you can press **POWER** to clear the alarm indicators.

1. While in Setup Mode, press **AIR** or **RANGE** to scroll to **Alarm Settings**.
2. Press **POWER** to select the menu item. The **Alarm Settings** menu appears.
3. Press **AIR** or **RANGE** to scroll to **Buzzer Silence**.
4. Press **POWER** to select the menu item. The **Buzzer Silence** menu appears with the cursor next to the current setting.

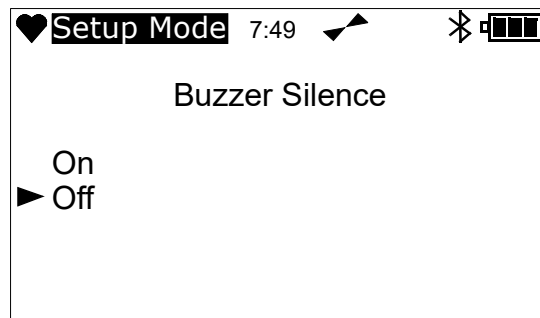

5. Press **AIR** or **RANGE** to scroll to the desired setting.
6. Press **POWER** to save the setting and return to the Alarm Settings menu.
7. To return to the Setup Mode menu:
 - a. Press **AIR** or **RANGE** to scroll to the **Escape** menu item.
 - b. Press **POWER** to select the menu item.
8. To exit Setup Mode:
 - a. Press **AIR** or **RANGE** to scroll to **Normal Operation**.
 - b. Press **POWER** to enter Normal Mode and begin the warmup sequence.

Turning the Sensor Life Alert On or Off

Enabled: The instrument indicates that a sensor is nearing expiration in the following ways:

- Gas name flashes during normal operation.
- Sensor life warning screen (LEDs flash, buzzer sounds) during calibration. Press **POWER** to acknowledge.

Disabled (factory setting): The instrument does not indicate when a sensor is nearing its expiration.

1. While in Setup Mode, press **AIR** or **RANGE** to scroll to **Alarm Settings**.
2. Press **POWER** to select the menu item. The **Alarm Settings** menu appears.
3. Press **AIR** or **RANGE** to scroll to **Sensor Life Alert**.
4. Press **POWER** to select the menu item. The **Sensor Life Alert** menu appears with the cursor next to the current setting.

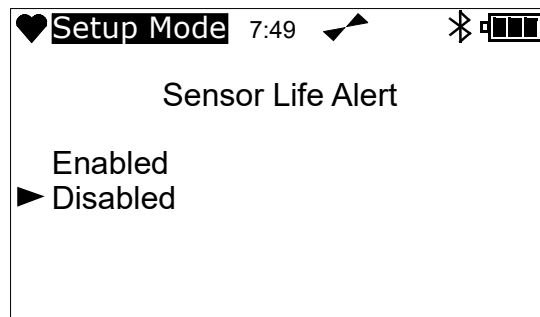

5. Press **AIR** or **RANGE** to scroll to the desired setting.
6. Press **POWER** to save the setting and return to the Alarm Settings menu.
7. To return to the Setup Mode menu:
 - a. Press **AIR** or **RANGE** to scroll to the **Escape** menu item.
 - b. Press **POWER** to select the menu item.
8. To exit Setup Mode:
 - a. Press **AIR** or **RANGE** to scroll to **Normal Operation**.
 - b. Press **POWER** to enter Normal Mode and begin the warmup sequence.

Saving the User Alarm Settings

Use this menu to save the current alarm settings as the instruments default alarm settings.

1. While in Setup Mode, press **AIR** or **RANGE** to scroll to **Alarm Settings**.
2. Press **POWER** to select the menu item. The **Alarm Settings** menu appears.
3. Press **AIR** or **RANGE** to scroll to **Save User Alarm**.
4. Press **POWER** to select the menu item. The following prompt appears.

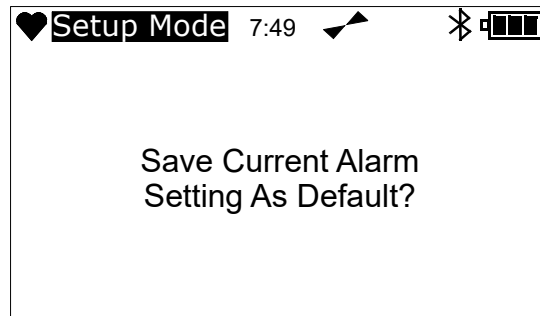

5. Press **POWER** or **AIR** to proceed to the confirmation screen.
To return to the Alarm Settings menu without restoring the user alarm settings, press **DISPLAY**.

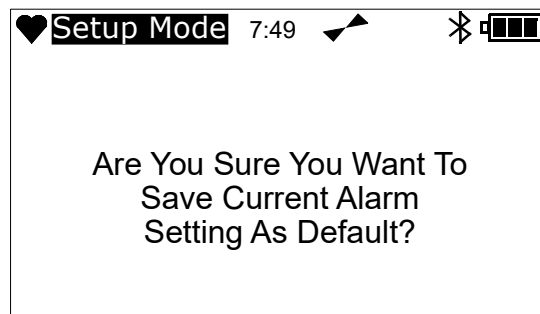

6. Press **POWER** or **AIR** to save the alarm points setting as the default alarm settings and return to the Alarm Settings menu.
To return to the Alarm Settings menu without saving the current user alarm points, press **DISPLAY**.
7. To return to the Setup Mode menu:
 - a. Press **AIR** or **RANGE** to scroll to the **Escape** menu item.
 - b. Press **POWER** to select the menu item.
8. To exit Setup Mode:
 - a. Press **AIR** or **RANGE** to scroll to **Normal Operation**.
 - b. Press **POWER** to enter Normal Mode and begin the warmup sequence.

Restoring the User Alarm Settings

Use this menu to restore the current alarm points to the user alarm settings saved in the **Save User Alarm** menu item (if performed).

1. While in Setup Mode, press **AIR** or **RANGE** to scroll to **Alarm Settings**.
2. Press **POWER** to select the menu item. The **Alarm Settings** menu appears.
3. Press **AIR** or **RANGE** to scroll to **Restore User Alarm**.
4. Press **POWER** to select the menu item. The following prompt appears.

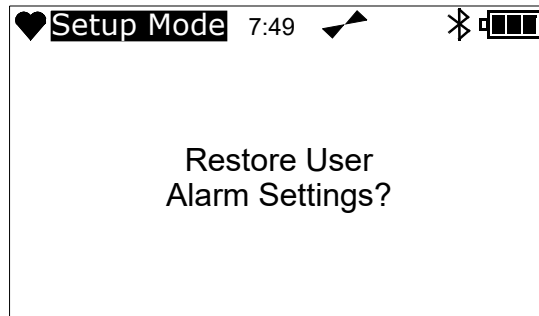

5. Press **POWER** to proceed to the confirmation screen.
To return to the Alarm Settings menu without restoring the user alarm settings, press **DISPLAY**.

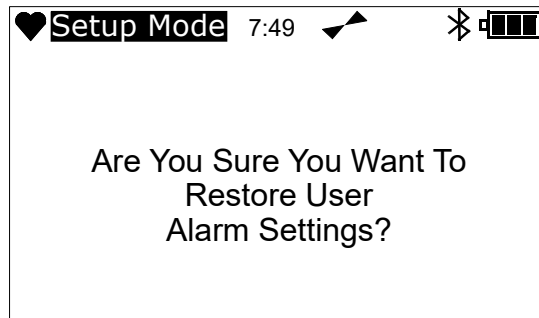

6. Press **POWER** or **AIR** to restore the alarm settings to the currently saved user alarm settings and return to the Alarm Settings menu.
To return to the Alarm Settings menu without restoring the user alarm settings, press **DISPLAY**.
7. To return to the Setup Mode menu:
 - a. Press **AIR** or **RANGE** to scroll to the **Escape** menu item.
 - b. Press **POWER** to select the menu item.
8. To exit Setup Mode:
 - a. Press **AIR** or **RANGE** to scroll to **Normal Operation**.
 - b. Press **POWER** to enter Normal Mode and begin the warmup sequence.

Restoring the 4 Gas Alarm Settings

Use this menu to restore alarm settings for the following four gases: CH₄, O₂, CO, and H₂S. See Table 1 for all four gases' default alarm points.

1. While in Setup Mode, press **AIR** or **RANGE** to scroll to **Alarm Settings**.
2. Press **POWER** to select the menu item. The **Alarm Settings** menu appears.
3. Press **AIR** or **RANGE** to scroll to **Restore 4 Gas Alarm**.
4. Press **POWER** to select the menu item. The following prompt appears.

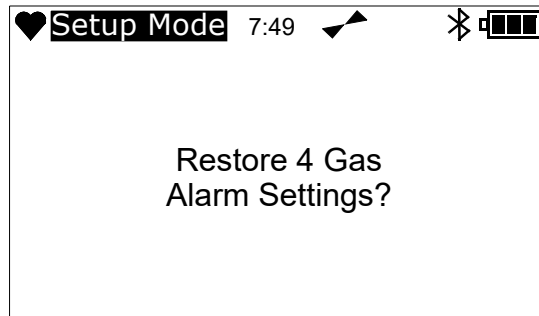

5. Press **POWER** to proceed to the confirmation screen.
To return to the Alarm Settings menu without restoring the four gas default alarm settings, press **DISPLAY**.

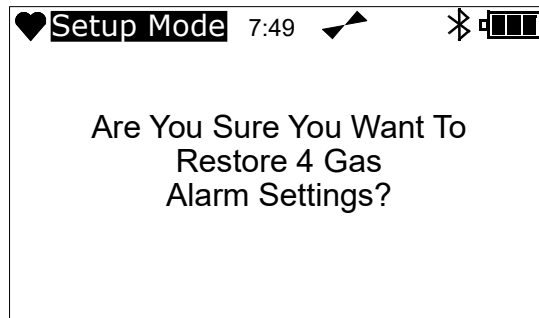

6. Press **POWER** to restore the alarm points to the four gas alarm settings and return to the Alarm Settings menu.
To return to the Alarm Settings menu without restoring the four gas alarm settings, press **DISPLAY**.
7. To return to the Setup Mode menu:
 - a. Press **AIR** or **RANGE** to scroll to the **Escape** menu item.
 - b. Press **POWER** to select the menu item.
8. To exit Setup Mode:
 - a. Press **AIR** or **RANGE** to scroll to **Normal Operation**.
 - b. Press **POWER** to enter Normal Mode and begin the warmup sequence.

Restoring the Factory Alarm Settings

1. While in Setup Mode, press **AIR** or **RANGE** to scroll to **Alarm Settings**.
2. Press **POWER** to select the menu item. The **Alarm Settings** menu appears.
3. Press **AIR** or **RANGE** to scroll to **Restore Fact. Alarm**.
4. Press **POWER** to select the menu item. The following prompt appears.

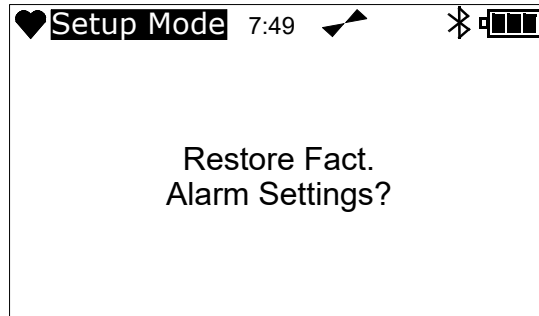

5. Press **POWER** to proceed to the confirmation screen.
To return to the Alarm Settings menu without restoring the factory alarm settings, press **DISPLAY**.

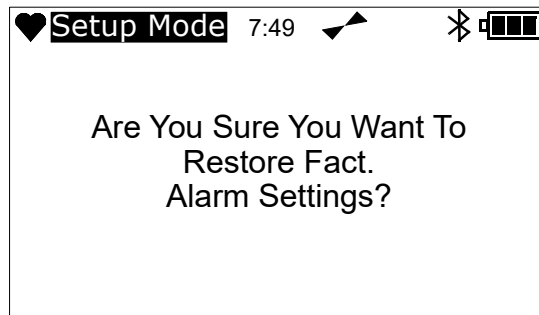

6. Press **POWER** to restore the current alarm settings to the factory alarm settings and return to the Alarm Settings menu.
To return to the Alarm Settings menu without restoring the factory alarm settings, press **DISPLAY**.
7. To return to the Setup Mode menu:
 - a. Press **AIR** or **RANGE** to scroll to the **Escape** menu item.
 - b. Press **POWER** to select the menu item.
8. To exit Setup Mode:
 - a. Press **AIR** or **RANGE** to scroll to **Normal Operation**.
 - b. Press **POWER** to enter Normal Mode and begin the warmup sequence.

Turning the User and Station ID On or Off

On: The ID Screen displays during start up and the **Select User ID?** screen and **Select Station ID?** screens appear in Display Mode. To select a new user ID, see page 69. To select a new station ID, see page 70.

Off (factory setting): The ID Screen does not display during start up and the **Select User ID?** screen and **Select Station ID?** screen do not appear in Display Mode.

1. While in Setup Mode, press **AIR** or **RANGE** to scroll to **User and Station ID**.

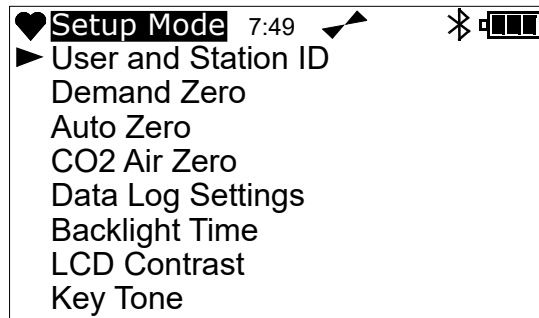

2. Press **POWER** to select the menu item. The **User and Station ID** screen appears with the cursor next to the current setting.

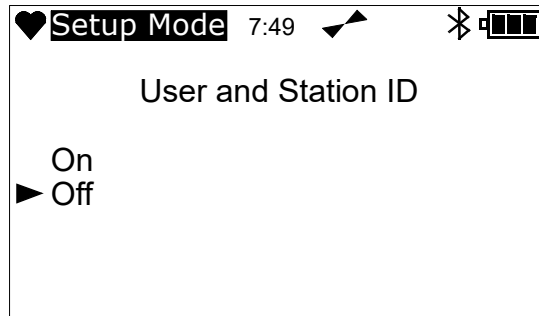

3. Press **AIR** or **RANGE** to scroll to the desired setting.
4. Press **POWER** to save the setting and return to the Setup Mode menu.
5. To exit Setup Mode:
 - a. Press **AIR** or **RANGE** to scroll to **Normal Operation**.
 - b. Press **POWER** to enter Normal Mode and begin the warmup sequence.

Turning Demand Zero On or Off (Demand Zero)

On (factory setting): Fresh air adjustments can be performed while in Normal Mode by pressing AIR.

Off: Fresh air adjustments cannot be performed while in Normal Mode.

1. While in Setup Mode, press **AIR** or **RANGE** to scroll to **Demand Zero**.

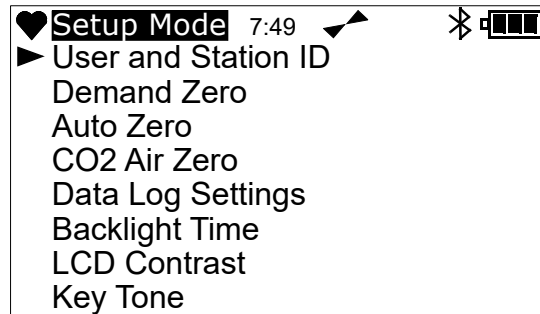

2. Press **POWER** to select the menu item. The **Demand Zero** screen appears with the cursor next to the current setting.

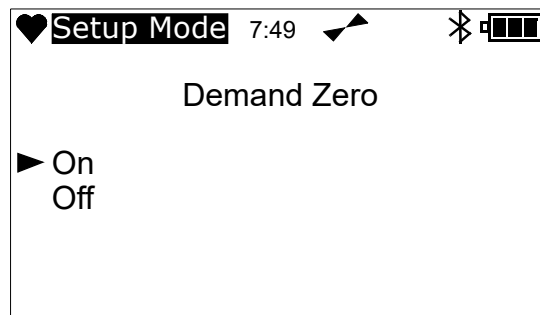

3. Press **AIR** or **RANGE** to scroll to the desired setting.
4. Press **POWER** to save the setting and return to the Setup Mode menu.
5. To exit Setup Mode:
 - a. Press **AIR** or **RANGE** to scroll to **Normal Operation**.
 - b. Press **POWER** to enter Normal Mode and begin the warmup sequence.

Turning Auto Zero On or Off (Auto Zero)

On: The EAGLE 3 asks if you want to perform a fresh air adjustment at the end of the warmup sequence.

Off (factory setting): The EAGLE 3 does not ask if you want to perform a fresh air adjustment at the end of the warmup sequence.

WARNING: *If the automatic fresh air feature is turned on, you must start up the EAGLE 3 in a known fresh air environment, an environment free of toxic or combustible gases and of normal oxygen content (20.9%). If this feature is on and the EAGLE 3 is started up in the presence of a target gas, the readings and alarms will not be accurate or reliable.*

1. While in Setup Mode, press **AIR** or **RANGE** to scroll to **Auto Zero**.

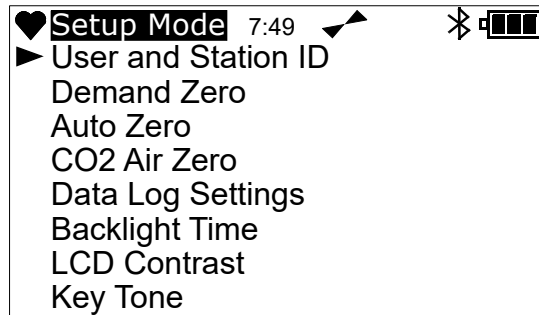

2. Press **POWER** to select the menu item. The **Auto Zero** screen appears with the cursor next to the current setting.

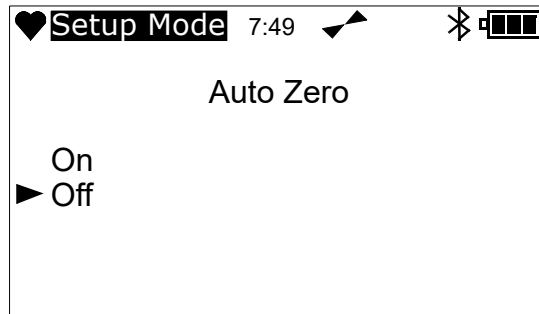

3. Press **AIR** or **RANGE** to scroll to the desired setting.
4. Press **POWER** to save the setting and return to the Setup Mode menu.
5. To exit Setup Mode:
 - a. Press **AIR** or **RANGE** to scroll to **Normal Operation**.
 - b. Press **POWER** to enter Normal Mode and begin the warmup sequence.

Turning CO₂ Air Zero On or Off

This menu item only appears if a CO₂ sensor is installed.

ON: CO₂ channel is set to 400 ppm (0.04% volume) during a demand zero, auto zero, or **Air Calibration**.

OFF (factory setting): CO₂ channel is not adjusted during a demand zero, auto zero, or **Air Calibration**.

1. While in Setup Mode, press **AIR** or **RANGE** to scroll to **CO₂ Air Zero**.

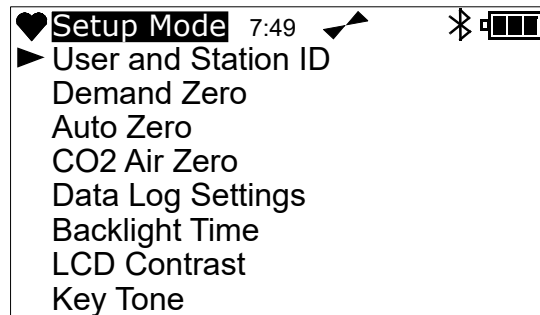

2. Press **POWER** to select the menu item. The **CO₂ Air Zero** screen appears with the cursor next to the current setting.

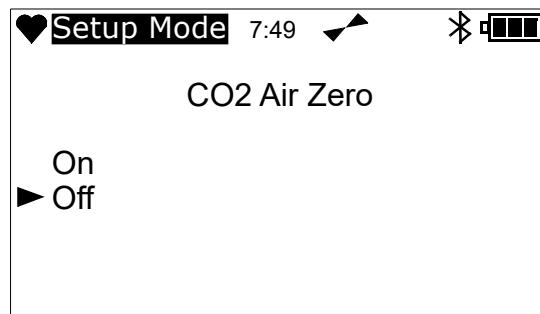

3. Press **AIR** or **RANGE** to scroll to the desired setting.
4. Press **POWER** to save the setting and return to the Setup Mode menu.
5. To exit Setup Mode:
 - a. Press **AIR** or **RANGE** to scroll to **Normal Operation**.
 - b. Press **POWER** to enter Normal Mode and begin the warmup sequence.

Adjusting the Data Log Settings

Selecting the Data Log Interval

This setting controls how often the EAGLE 3 saves readings to the data logger. The following interval times can be selected: 10 minutes, 5 minutes, 3 minutes, 1 minute, **30 seconds** (factory setting), 20 seconds, 10 seconds, 5 seconds, 4 seconds, 3 seconds, 2 seconds, and 1 second.

1. While in Setup Mode, press **AIR** or **RANGE** to scroll to **Data Log Settings**.

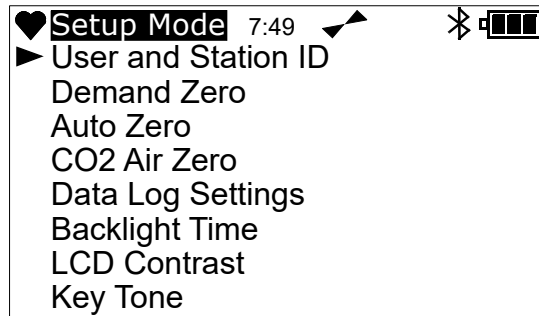

2. Press **POWER** to select the menu item. The Data Log Settings menu appears.

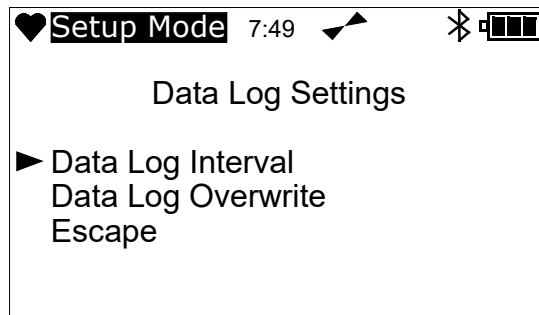

3. Press **AIR** or **RANGE** to scroll to the **Data Log Interval** menu item.
4. Press **POWER** to select the menu item. The **Data Log Interval** screen appears with the cursor next to the current setting.

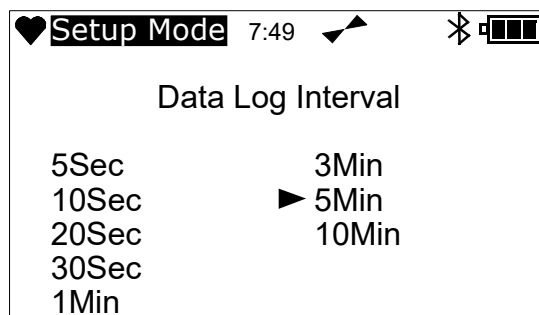

5. Press **AIR** or **RANGE** to scroll to the desired setting.
6. Press **POWER** to save the setting and return to the Data Log Settings menu.

7. To return to the Setup Mode menu:
 - a. Press **AIR** or **RANGE** to scroll to the **Escape** menu item.
 - b. Press **POWER** to select the menu item.
8. To exit Setup Mode:
 - a. Press **AIR** or **RANGE** to scroll to **Normal Operation**.
 - b. Press **POWER** to enter Normal Mode and begin the warmup sequence.

Turning Data Log Overwrite On or Off

On (factory setting): When the EAGLE 3's data log memory is full, it overwrites the oldest data logs with the most recent data logs.

Off: The EAGLE 3 stops saving data to the data logger when the data logger memory is full.

1. While in Setup Mode, press **AIR** or **RANGE** to scroll to **Data Log Settings**.
2. Press **POWER** to select the menu item. The Data Log Settings menu appears.

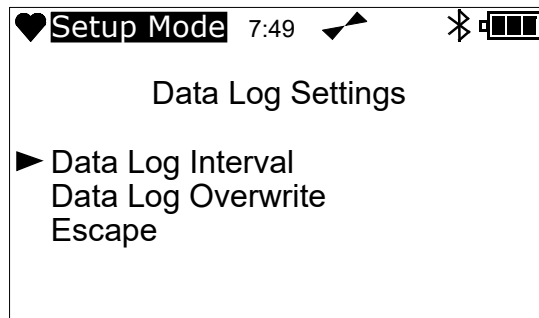

3. Press **AIR** or **RANGE** to scroll to the **Data Log Overwrite** menu item.
4. Press **POWER** to select the menu item. The **Data Log Overwrite** screen appears with the cursor next to the current setting.

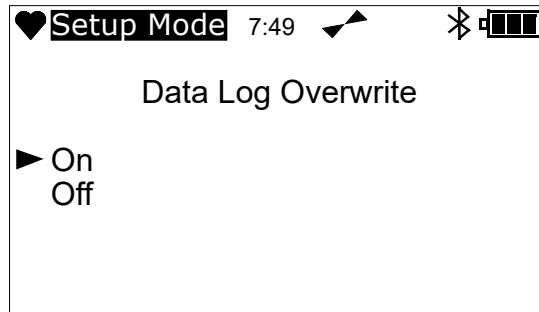

5. Press **AIR** or **RANGE** to scroll to the desired setting.
6. Press **POWER** to save the setting and return to Data Log Settings menu.
7. To return to the Setup Mode menu:
 - a. Press **AIR** or **RANGE** to scroll to the **Escape** menu item.
 - b. Press **POWER** to select the menu item.

8. To exit Setup Mode:
 - a. Press **AIR** or **RANGE** to scroll to **Normal Operation**.
 - b. Press **POWER** to enter Normal Mode and begin the warmup sequence.

Selecting the Backlight Time

This setting defines how long the LCD backlight stays on when you press any button. The minimum setting is 0 seconds; the maximum setting is 10 minutes. The factory setting is **30 seconds**.

1. While in Setup Mode, press **AIR** or **RANGE** to scroll to **Backlight Time**.

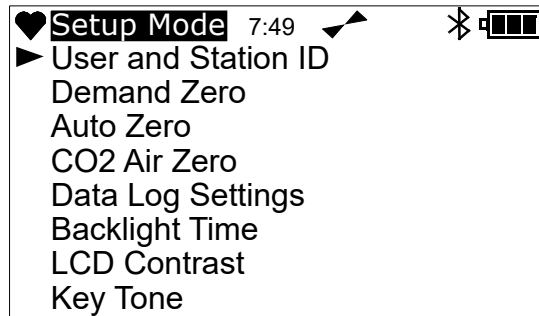

2. Press **POWER** to select the menu item. The **Backlight Time** screen appears with the cursor next to the current setting.

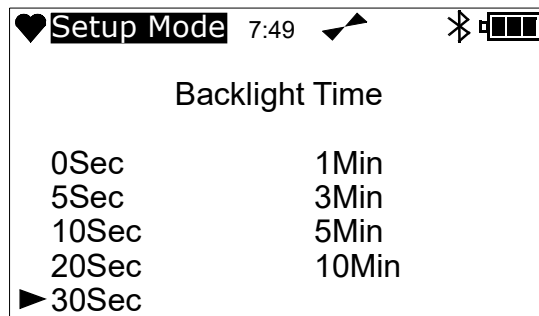

3. Press **AIR** or **RANGE** to scroll to the desired setting.
4. Press **POWER** to save the setting and return to Setup Mode menu.
5. To exit Setup Mode:
 - a. Press **AIR** or **RANGE** to scroll to **Normal Operation**.
 - b. Press **POWER** to enter Normal Mode and begin the warmup sequence.

Adjusting the LCD Contrast

Use this setting to adjust the LCD contrast. Select the setting so the characters on the display are easy to see. Increasing the contrast darkens the characters and LCD background.

The LCD contrast can be set from **1 - 50**. The factory setting is **20**.

1. While in Setup Mode, press **AIR** or **RANGE** to scroll to **LCD Contrast**.

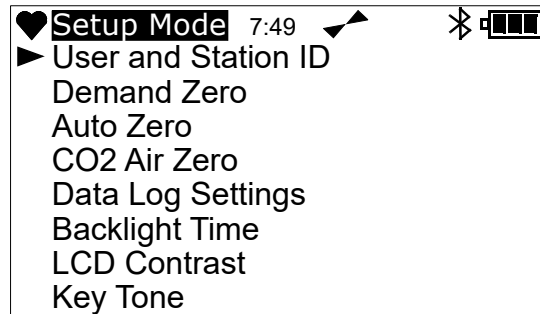

2. Press **POWER** to select the menu item. The **LCD Contrast** screen appears with the current contrast value flashing.

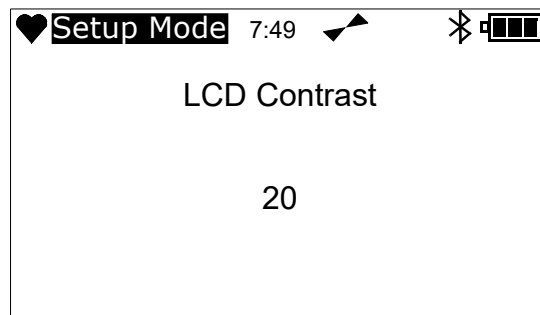

3. Press **AIR** or **RANGE** to adjust the setting so that the characters on the LCD are easily visible.
4. Press **POWER** to save the desired setting and return to Setup Mode.
5. To exit Setup Mode:
 - a. Press **AIR** or **RANGE** to scroll to **Normal Operation**.
 - b. Press **POWER** to enter Normal Mode and begin the warmup sequence.

Turning the Key Tone On/Off

On (factory setting): The instrument beeps when a button is pressed.

Off: The instrument does not beep when a button is pressed.

1. While in Setup Mode, press **AIR** or **RANGE** to scroll to **Key Tone**.

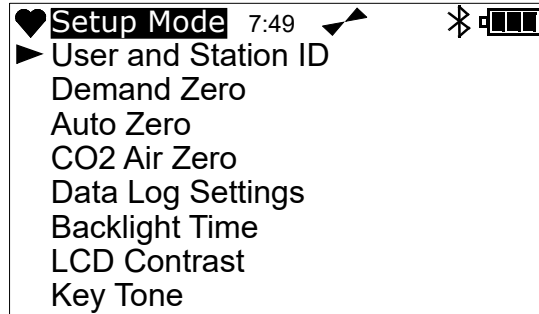

2. Press **POWER** to select the menu item. The **Key Tone** screen appears with the cursor next to the current setting.

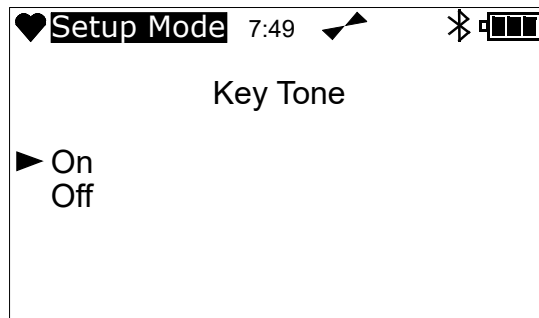

3. Press **AIR** or **RANGE** to scroll to the desired setting.
4. Press **POWER** to save the setting and return to Setup Mode menu.
5. To exit Setup Mode:
 - a. Press **AIR** or **RANGE** to scroll to **Normal Operation**.
 - b. Press **POWER** to enter Normal Mode and begin the warmup sequence.

Calibration Settings

Turning the Calibration Reminder On or Off

Use this menu to turn the Calibration Reminder feature **On** (factory setting) or **Off**. When this feature is enabled, the EAGLE 3 will indicate at start up if it is due for calibration. The type of indicator will depend on the **Calibration Past Due Act** setting (see page 148).

1. While in Setup Mode, press **AIR** or **RANGE** to scroll to **Calibration Settings**.

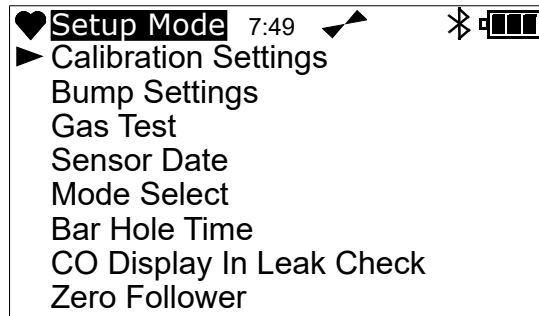

2. Press **POWER** to select the menu item. The **Calibration Settings** menu appears.

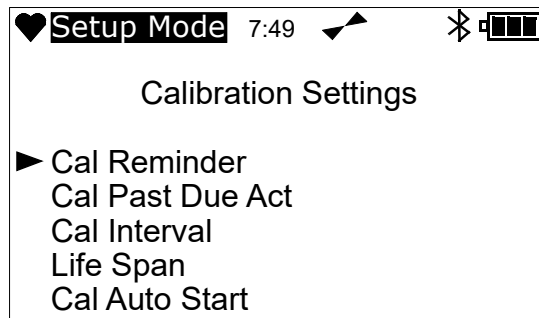

3. Press **AIR** or **RANGE** to scroll to the **Calibration Reminder** menu item.
4. Press **POWER** to select the menu item. The **Calibration Reminder** menu appears with the cursor next to the current setting.

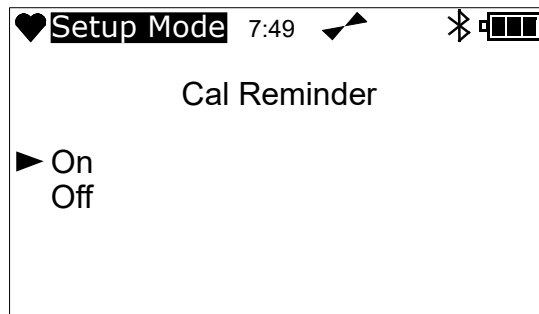

5. Press **AIR** or **RANGE** to scroll to the desired setting.
6. Press **POWER** to save the setting and return to Setup Mode menu.

7. To return to the Setup Mode menu:
 - a. Press **AIR** or **RANGE** to scroll to the **Escape** menu item.
 - b. Press **POWER** to select the menu item.
8. To exit Setup Mode:
 - a. Press **AIR** or **RANGE** to scroll to **Normal Operation**.
 - b. Press **POWER** to enter Normal Mode and begin the warmup sequence.

Selecting the Calibration Past Due Action Setting

Use this menu to select the Calibration Past Due Action for when **Calibration Reminder** is set to **On** and a calibration is past due. The following options are detailed below: **Confirm to Use**, **Cannot Use**, and **No Effect**.

- **Confirm to Use:** If the unit is due for a calibration, the EAGLE 3 displays a prompt to continue with the warm up sequence or perform a calibration. To acknowledge the reminder, skip the calibration, and resume warmup, press **DISPLAY**.
 - **Cannot Use:** If the unit is due for a calibration, the buzzer will pulse twice a second and the EAGLE 3 displays a prompt to begin a calibration. Press **AIR** to proceed. If **AIR** is not pressed after five seconds, the unit enters Calibration Mode. See page 87 for performing a calibration.
 - **No Effect:** If the unit is due for a calibration, the buzzer will pulse twice a second and the EAGLE 3 displays a reminder to calibration the instrument and the option to resume with the warm up sequence or perform a calibration. After a few seconds, the unit resumes the warmup sequence.
1. While in Setup Mode, press **AIR** or **RANGE** to scroll to **Calibration Settings**.
 2. Press **POWER** to select the menu item. The **Calibration Settings** menu appears.
 3. Press **AIR** or **RANGE** to scroll to the **Calibration Past Due Act** menu item.
 4. Press **POWER** to select the menu item. The **Calibration Past Due Act** menu appears with the cursor next to the current setting.

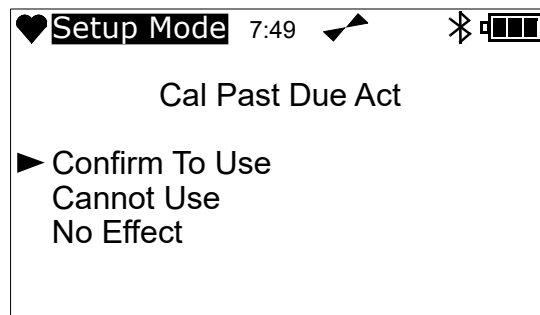

5. Press **AIR** or **RANGE** to scroll to the desired setting.
6. Press **POWER** to save the setting and return to the Calibration Settings menu.

7. To return to the Setup Mode menu:
 - a. Press **AIR** or **RANGE** to scroll to the **Escape** menu item.
 - b. Press **POWER** to select the menu item.
8. To exit Setup Mode:
 - a. Press **AIR** or **RANGE** to scroll to **Normal Operation**.
 - b. Press **POWER** to enter Normal Mode and begin the warmup sequence.

Adjusting the Calibration Interval

Use this menu to adjust the time between calibrations. The available intervals is **0 - 365 days**. The factory setting is **90 Days**.

1. While in Setup Mode, press **AIR** or **RANGE** to scroll to **Calibration Settings**.
2. Press **POWER** to select the menu item. The **Calibration Settings** menu appears.
3. Press **AIR** or **RANGE** to scroll to the **Cal Interval** menu item.
4. Press **POWER** to select the menu item. The **Cal Interval** menu appears with the current interval displayed.

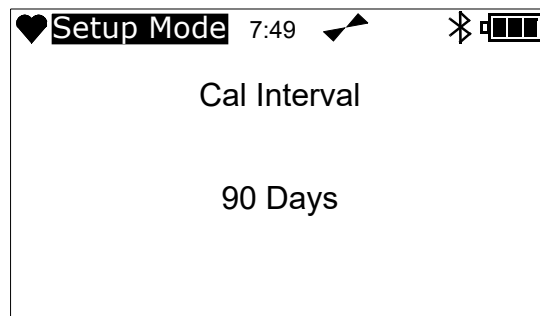

5. Press **AIR** or **RANGE** until the desired number of days is displayed.
6. Press **POWER** to save the setting and return to the **Calibration Settings** menu.
7. To return to the Setup Mode menu:
 - a. Press **AIR** or **RANGE** to scroll to the **Escape** menu item.
 - b. Press **POWER** to select the menu item.
8. To exit Setup Mode:
 - a. Press **AIR** or **RANGE** to scroll to **Normal Operation**.
 - b. Press **POWER** to enter Normal Mode and begin the warmup sequence.

Turning Life Span On or Off

Use this menu to turn the Life Span feature **On** (factory setting) and **Off**. When this feature is enabled, the EAGLE 3 will display the span adjustment range for a sensor in the calibration results screen. The span adjustment shows how low and how high the reading could have been adjusted.

1. While in Setup Mode, press **AIR** or **RANGE** to scroll to **Calibration Settings**.
2. Press **POWER** to select the menu item. The **Calibration Settings** menu appears.
3. Press **AIR** or **RANGE** to scroll to the **Life Span** menu item.
4. Press **POWER** to select the menu item. The **Life Span** screen appears with the cursor next to the current setting.

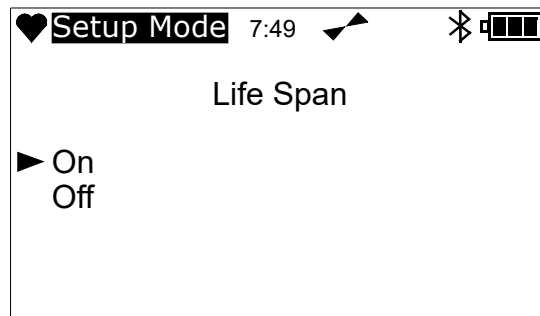

5. Press **AIR** or **RANGE** to move the cursor next to the desired setting.
6. Press **POWER** to save the setting and return to the **Calibration Settings** menu.
7. To return to the Setup Mode menu:
 - a. Press **AIR** or **RANGE** to scroll to the **Escape** menu item.
 - b. Press **POWER** to select the menu item.
8. To exit Setup Mode:
 - a. Press **AIR** or **RANGE** to scroll to **Normal Operation**.
 - b. Press **POWER** to enter Normal Mode and begin the warmup sequence.

Turning Calibration Auto Start On or Off

Use this menu to select whether the instrument automatically begins the warmup sequence if it passes calibration. The factory setting is **On**.

1. While in Setup Mode, press **AIR** or **RANGE** to scroll to **Calibration Settings**.
2. Press **POWER** to select the menu item. The **Calibration Settings** menu appears.
3. Press **AIR** or **RANGE** to scroll to the **Cal Auto Start** menu item.

4. Press **POWER** to select the menu item. The **Cal Auto Start** screen appears with the cursor next to the current setting.

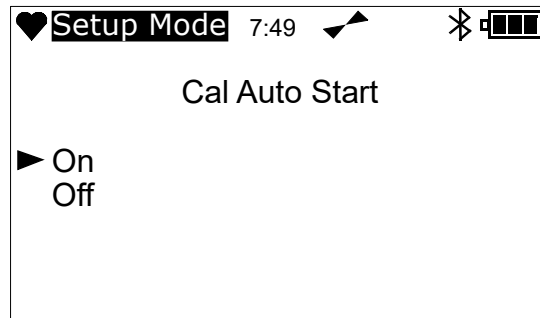

5. Press **AIR** or **RANGE** to move the cursor next to the desired setting.
6. Press **POWER** to save the setting and return to the **Calibration Settings** menu.
7. To return to the Setup Mode menu:
 - a. Press **AIR** or **RANGE** to scroll to the **Escape** menu item.
 - b. Press **POWER** to select the menu item.
8. To exit Setup Mode:
 - a. Press **AIR** or **RANGE** to scroll to **Normal Operation**.
 - b. Press **POWER** to enter Normal Mode and begin the warmup sequence.

Bump Settings

Turning Bump Reminder On or Off

Use this menu to turn the Bump Reminder feature on and off (factory setting). When this feature is enabled, the EAGLE 3 will indicate at start up if it is due for a bump test. The type of indicator will depend on the **Bump Past Due Act** setting (see page 153).

1. While in Setup Mode, press **AIR** or **RANGE** to scroll to **Bump Settings**.

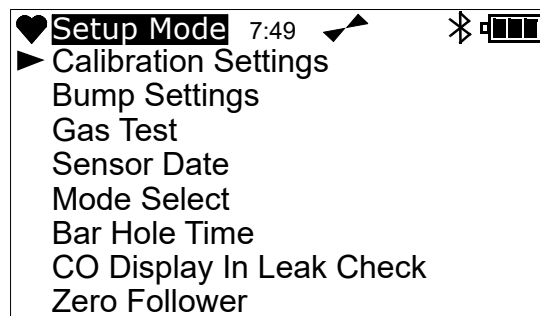

2. Press **POWER** to select the menu item. The Bump Settings screen appears.

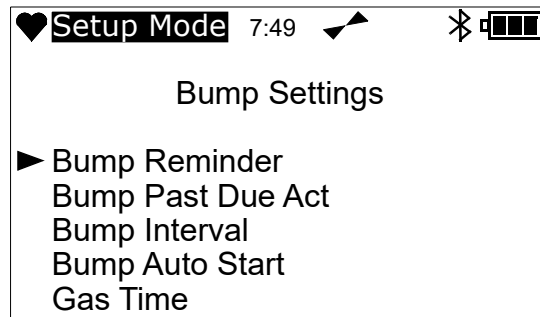

3. Press **AIR** or **RANGE** to scroll to the **Bump Reminder** menu item.
4. Press **POWER** to select the menu item. The **Bump Reminder** screen appears with the cursor next to the current setting.

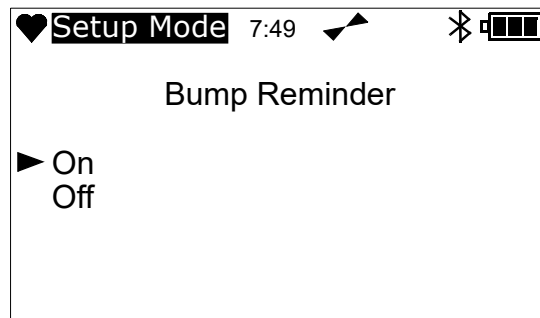

5. Press **AIR** or **RANGE** to move the cursor next to the desired setting.
6. Press **POWER** to save the setting and return to the Bump Settings menu.
7. To return to the Setup Mode menu, press **AIR** or **RANGE** to scroll to the **Escape** menu item. Press **POWER** to select the menu item.
8. To exit Setup Mode:
 - a. Press **AIR** or **RANGE** to scroll to **Normal Operation**.
 - b. Press **POWER** to enter Normal Mode and begin the warmup sequence.

Selecting the Bump Past Due Action

Use this menu to select the Bump Past Due Action for when **Bump Test Reminder** is set to **On** and a bump test is past due. The following options are detailed below: **Confirm to Use**, **Cannot Use**, and **No Effect**.

- **Confirm to Use:** If the unit is due for a bump test, the EAGLE 3 displays a prompt to continue with the warm up sequence or perform a bump test. To acknowledge the reminder, skip the bump test, and resume warmup, press **DISPLAY**.
- **Cannot Use:** If the unit is due for a bump test, the buzzer will pulse twice a second and the EAGLE 3 displays a prompt to begin a bump test. Press **AIR** to proceed. If **AIR** is not pressed after five seconds, the unit enters Calibration Mode. See page 80 for performing a bump test.
- **No Effect:** If the unit is due for a bump test, the buzzer will pulse twice a second and the EAGLE 3 displays a reminder to bump test the instrument and the option to resume with the warm up sequence or perform a bump test. After a few seconds, the unit resumes the warmup sequence.

1. While in Setup Mode, press **AIR** or **RANGE** to scroll to **Bump Settings**.
2. Press **POWER** to select the menu item. The Bump Settings menu appears.

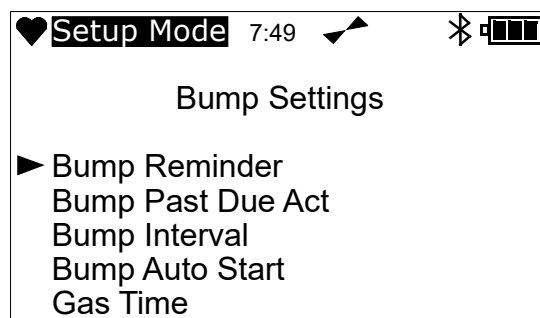

3. Press **AIR** or **RANGE** to scroll to the **Bump Past Due Act** menu item.
4. Press **POWER** to select the menu item. The **Bump Past Due Act** screen appears with the cursor next to the current setting.

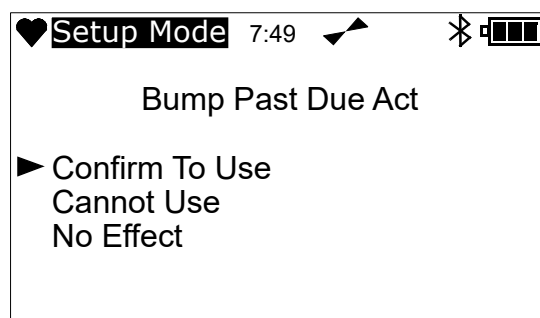

5. Press **AIR** or **RANGE** to scroll to the desired setting.
6. Press **POWER** to save the setting and return to the Bump Settings menu.

7. To return to the Setup Mode menu:
 - a. Press **AIR** or **RANGE** to scroll to the **Escape** menu item.
 - b. Press **POWER** to select the menu item.
8. To exit Setup Mode:
 - a. Press **AIR** or **RANGE** to scroll to **Normal Operation**.
 - b. Press **POWER** to enter Normal Mode and begin the warmup sequence.

Adjusting the Bump Test Interval

Use this menu to adjust how often a bump test should be performed. The time can be set in 1 day increments. The available intervals are from **0 - 60 Days**. The factory setting is **30 Days**.

1. While in Setup Mode, press **AIR** or **RANGE** to scroll to **Bump Settings**.
2. Press **POWER** to select the menu item. The Bump Settings menu appears.

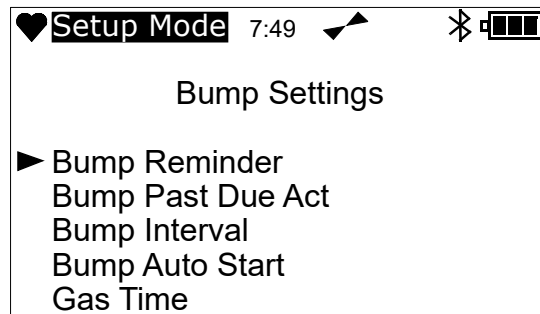

3. Press **AIR** or **RANGE** to scroll to the **Bump Interval** menu item.
4. Press **POWER** to select the menu item. The **Bump Interval** screen appears with the current interval setting displayed.

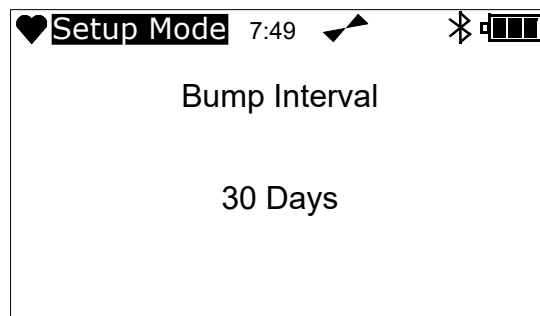

5. Press **AIR** or **RANGE** until the desired number of days is displayed.

NOTE: The **AIR** or **RANGE** buttons can be held down to increase the scroll speed.

6. Press **POWER** to save the setting and return to the Bump Settings menu.
7. To return to the Setup Mode menu:
 - a. Press **AIR** or **RANGE** to scroll to the **Escape** menu item.
 - b. Press **POWER** to select the menu item.

8. To exit Setup Mode:
 - a. Press **AIR** or **RANGE** to scroll to **Normal Operation**.
 - b. Press **POWER** to enter Normal Mode and begin the warmup sequence.

Turning Bump Auto Start On or Off

Use this menu to select whether the instrument automatically begins the warmup sequence after passing a bump test. The factory setting is **On**.

1. While in Setup Mode, press **AIR** or **RANGE** to scroll to **Bump Settings**.
2. Press **POWER** to select the menu item. The Bump Settings menu appears.

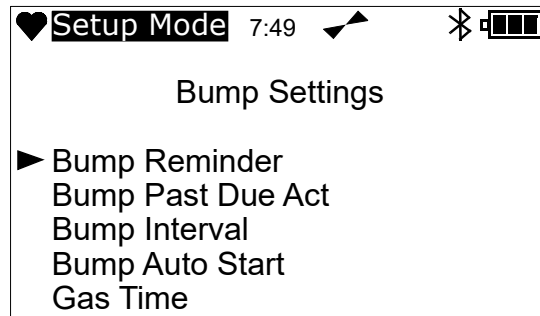

3. Press **AIR** or **RANGE** to scroll to the **Bump Auto Start** menu item.
4. Press **POWER** to select the menu item. The **Bump Auto Start** screen appears with the cursor next to the current setting.

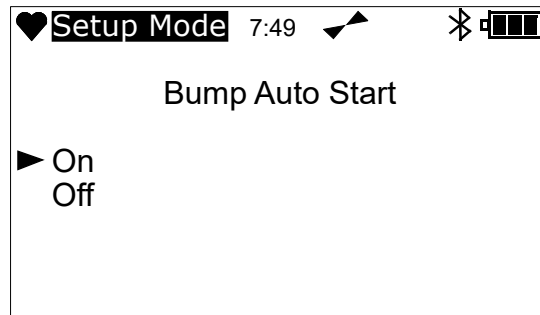

5. Press **AIR** or **RANGE** to scroll to the desired setting.
6. Press **POWER** to save the setting and return to the Bump Settings menu.
7. To return to the Setup Mode menu:
 - a. Press **AIR** or **RANGE** to scroll to the **Escape** menu item.
 - b. Press **POWER** to select the menu item.
8. To exit Setup Mode:
 - a. Press **AIR** or **RANGE** to scroll to **Normal Operation**.
 - b. Press **POWER** to enter Normal Mode and begin the warmup sequence.

Selecting the Gas Time

Use this menu to select the length of time the EAGLE 3 draws calibration gas during a bump test.
Options: **30 seconds** (factory setting), 45 seconds, 60 seconds, and 90 seconds

1. While in Setup Mode, press **AIR** or **RANGE** to scroll to **Bump Settings**.
2. Press **POWER** to select the menu item. The Bump Settings menu appears.

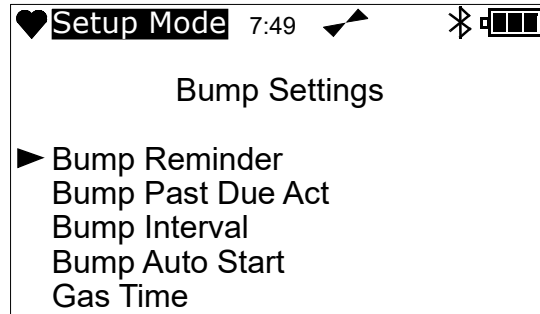

3. Press **AIR** or **RANGE** to scroll to the **GasTime** menu item.
4. Press **POWER** to select the menu item. The **GasTime** screen appears with the cursor next to the current setting.

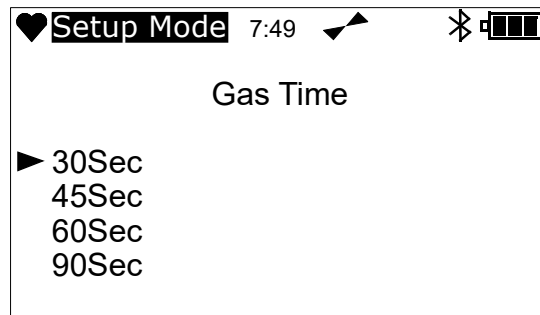

5. Press **AIR** or **RANGE** to scroll to the desired setting.
6. Press **POWER** to save the setting and return to the Bump Settings menu.
7. To return to the Setup Mode menu:
 - a. Press **AIR** or **RANGE** to scroll to the **Escape** menu item.
 - b. Press **POWER** to select the menu item.
8. To exit Setup Mode:
 - a. Press **AIR** or **RANGE** to scroll to **Normal Operation**.
 - b. Press **POWER** to enter Normal Mode and begin the warmup sequence.

Adjusting the Tolerance

Use this menu to adjust how close the gas reading has to be to the calibration gas value to pass the bump test. For example, if the tolerance is set to 50%, and the %LEL calibration gas concentration is 50% LEL, then the bump test gas reading for the LEL channel on the EAGLE 3 must be 50% LEL \pm 25% LEL.

Options: 10, 20, 30, 40, **50%** (factory setting)

1. While in Setup Mode, press **AIR** or **RANGE** to scroll to **Bump Settings**.
2. Press **POWER** to select the menu item. The Bump Settings menu appears.

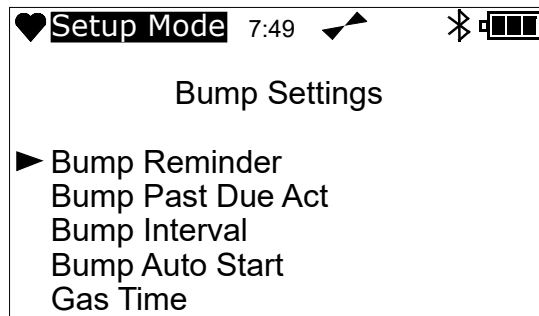

3. Press **AIR** or **RANGE** to scroll to the **Tolerance** menu item.
4. Press **POWER** to select the menu item. The **Tolerance** screen appears with the cursor next to the current setting.

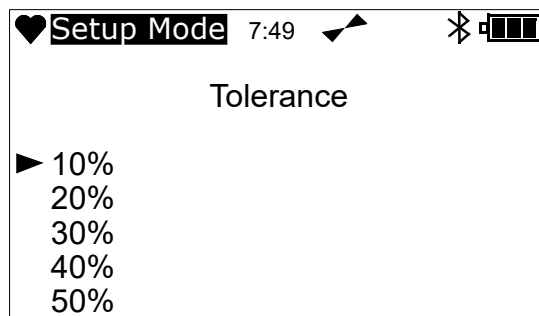

5. Press **AIR** or **RANGE** to scroll to the desired setting.
6. Press **POWER** to save the setting and return to the Bump Settings menu.
7. To return to the Setup Mode menu:
 - a. Press **AIR** or **RANGE** to scroll to the **Escape** menu item.
 - b. Press **POWER** to select the menu item.
8. To exit Setup Mode:
 - a. Press **AIR** or **RANGE** to scroll to **Normal Operation**.
 - b. Press **POWER** to enter Normal Mode and begin the warmup sequence.

Selecting the Calibration Time

Use this menu to select the total time that the instrument is exposed to calibration gas when a bump test fails and **Auto Cal** is set to **On**. The bump test time is deducted from the calibration time. For example, if the **Cal Time** is set to 90 seconds, the **GasTime** is set to 30 seconds, and the bump test fails, the EAGLE 3 will only be exposed to gas for an additional 60 seconds. The available values are **90 seconds** (factory setting) and **120 seconds**.

1. While in Setup Mode, press **AIR** or **RANGE** to scroll to **Bump Settings**.
2. Press **POWER** to select the menu item. The Bump Settings menu appears.

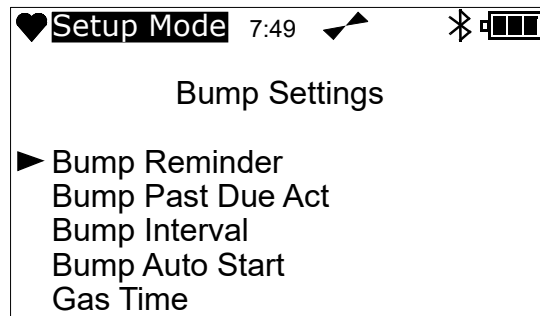

3. Press **AIR** or **RANGE** to scroll to the **Cal Time** menu item.
4. Press **POWER** to select the menu item. The **Cal Time** screen appears with the cursor next to the current setting.

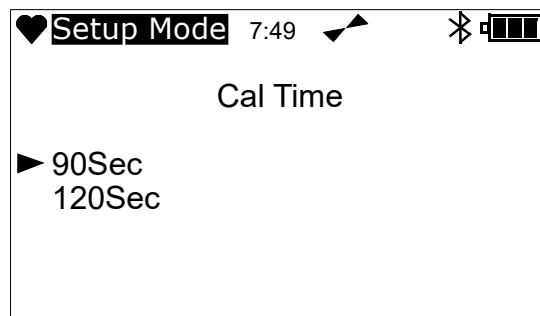

5. Press **AIR** or **RANGE** to turn the setting on or off.
6. Press **POWER** to save the setting and return to the Bump Settings menu.
7. To return to the Setup Mode menu:
 - a. Press **AIR** or **RANGE** to scroll to the **Escape** menu item.
 - b. Press **POWER** to select the menu item.
8. To exit Setup Mode:
 - a. Press **AIR** or **RANGE** to scroll to **Normal Operation**.
 - b. Press **POWER** to enter Normal Mode and begin the warmup sequence.

Turning Auto Calibration On or Off

Use this menu to control whether or not the instrument automatically starts a calibration after a failed bump test. Factory setting is **On**.

1. While in Setup Mode, press **AIR** or **RANGE** to scroll to **Bump Settings**.
2. Press **POWER** to select the menu item. The Bump Settings menu appears.

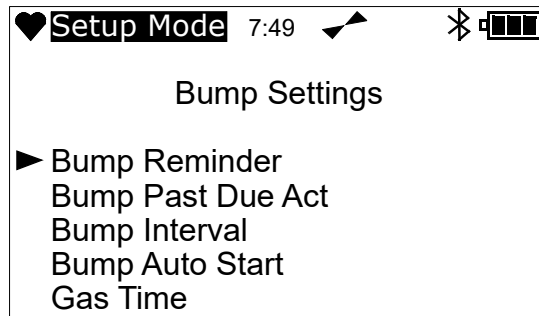

3. Press **AIR** or **RANGE** to scroll to the **Auto Cal** menu item.
4. Press **POWER** to select the menu item. The **Auto Cal** screen appears with the cursor next to the current setting.

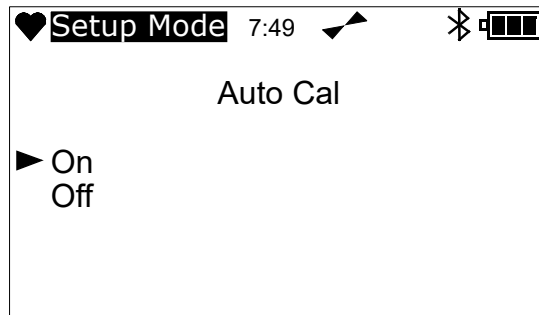

5. Press **AIR** or **RANGE** to turn the setting on or off.
6. Press **POWER** to save the setting and return to the Bump Settings menu.
7. To return to the Setup Mode menu:
 - a. Press **AIR** or **RANGE** to scroll to the **Escape** menu item.
 - b. Press **POWER** to select the menu item.
8. To exit Setup Mode:
 - a. Press **AIR** or **RANGE** to scroll to **Normal Operation**.
 - b. Press **POWER** to enter Normal Mode and begin the warmup sequence.

Performing a Gas Test

Use this menu item to confirm that the EAGLE 3 is responding to gas without recording a bump test or an alarm condition.

1. While in Setup Mode, press **AIR** or **RANGE** to scroll to **Gas Test**.

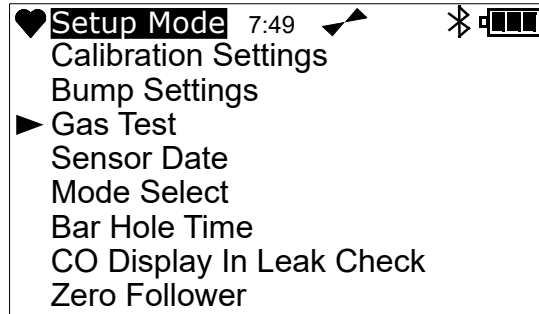

2. Press **POWER** to begin alarm testing.
3. Install the demand flow regulator onto the calibration cylinder.
4. Connect the sample tubing to the demand flow regulator.
5. Install the probe on the EAGLE 3 inlet fitting. Make sure the probe is complete with internal O-ring and membrane and that the two halves of the probe are tightened firmly together to avoid leaks that can affect the calibration. See Figure 18 on page 100 for an illustration of the internal parts of the probe.
6. The channel readings will be displayed and updated as the test proceeds. The buzzer will sound if it has been enabled.

♥ Setup Mo 7:49 [Signal] [Bluetooth] [Battery]			
CH4 %LEL	O2 %	CO ppm	
0	20.9	0	
H2S ppm	NH3 ppm		
0.0	0.0		
Gas Test		Buzzer	

7. Once the readings have stabilized or have reached the desired levels, remove the calibration tubing from the probe.
8. To return to Setup Mode, press **POWER**.
9. To exit Setup Mode:
 - a. Press **AIR** or **RANGE** to scroll to **Normal Operation**.
 - b. Press **POWER** to enter Normal Mode and begin the warmup sequence.

Setting the Sensor Replacement Date (Sensor Date)

Use this menu item to enter and save the sensor replacement date for each sensor.

1. While in Setup Mode, press **AIR** or **RANGE** to scroll to **Sensor Date**.

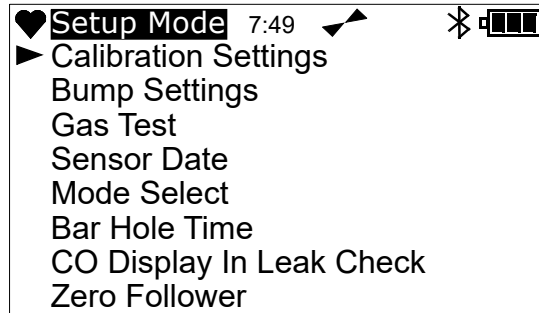

2. Press **POWER**. The **Sensor Date** screen appears with the first channel and a date placeholder.

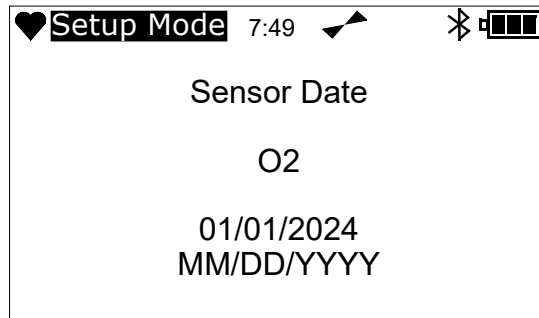

3. Press **AIR** or **RANGE** until the year matches the year of the sensor's replacement date.

NOTE: The **AIR** or **RANGE** buttons can be held down to increase the scroll speed.

4. Press **POWER** to save the year and move to the month.
5. Repeat Step 2 through Step 4 to enter the month and day.
6. To exit Setup Mode:
 - a. Press **AIR** or **RANGE** to scroll to **Normal Operation**.
 - b. Press **POWER** to enter Normal Mode and begin the warmup sequence.

Selecting the Mode Setting (Mode Select)

Use this menu to configure the **Mode Select** screen and the available options. The options are detailed below.

See page 248 and page 257 for discussions of Bar Hole Mode and Leak Check Mode, respectively.

- **Off (factory setting):** The Mode Select Screen does not appear when the unit is turned on and the unit goes into Normal Mode after the start up sequence. **Off** is the factory setting unless the instrument is ordered for bar hole measurement or leak checking use.
 - **Leak Check:** The Mode Select Screen appears when the unit is turned on. The available options are Normal Mode and Leak Check Mode.
 - **Bar Hole:** The Mode Select Screen appears when the unit is turned on. The available options are Normal Mode and Bar Hole Mode.
 - **Leak & Bar Hole:** The Mode Select Screen appears when the unit is turned on. The available options are Normal Mode, Leak Check Mode, and Bar Hole Mode.
 - **Inert:** The Mode Select Screen appears when the unit is turned on. The available options are Normal Mode, Leak Check Mode, and Bar Hole Mode.
1. While in Setup Mode, press **AIR** or **RANGE** to scroll to **Mode Select**.

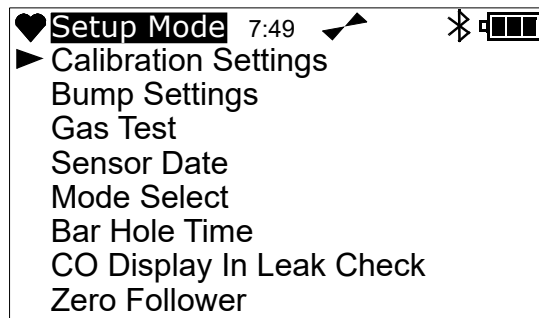

2. Press **POWER** to select the menu item. The **Mode Select** screen appears with the cursor next to the current setting.
3. Press **AIR** or **RANGE** to scroll to the desired mode.
4. Press **POWER** to save the setting and return to the Setup Mode menu.
5. To exit Setup Mode:
 - a. Press **AIR** or **RANGE** to scroll to **Normal Operation**.
 - b. Press **POWER** to enter Normal Mode and begin the warmup sequence.

Selecting the Bar Hole Measurement Time

Use this menu to select the length of time the unit will sample when a bar hole measurement is initiated in Bar Hole Mode. It can be set to **30** (factory setting), 45, or 60 seconds.

1. While in Setup Mode, press **AIR** or **RANGE** to scroll to **Bar Hole Time**.

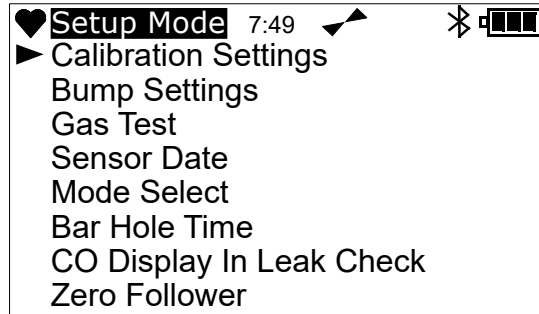

2. Press **POWER** to select the menu item. The **Bar Hole Time** screen appears with the cursor next to the current setting.

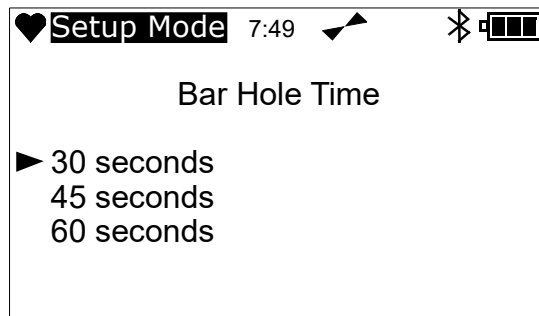

3. Press **AIR** or **RANGE** to scroll to the desired setting.
4. Press **POWER** to save the setting and return to the Setup Mode menu.
5. To exit Setup Mode:
 - a. Press **AIR** or **RANGE** to scroll to **Normal Operation**.
 - b. Press **POWER** to enter Normal Mode and begin the warmup sequence.

Turning CO Display In Leak Check On or Off

On: The CO channel will be displayed in Leak Check Mode, but there will be no CO alarms. If any snap logs are taken while **CO Display In Leak Check** is set to **On**, the CO reading is saved but will not be displayed during the snap log and will not appear while reviewing the snap log data on the instrument. However, the CO reading(s) can be viewed using the EAGLE 3 Datalogging Program.

Off (factory setting): The CO channel is not displayed in Leak Check Mode. This setting has no effect on Normal Mode.

1. While in Setup Mode, press **AIR** or **RANGE** to scroll to **CO Display In Leak Check**.

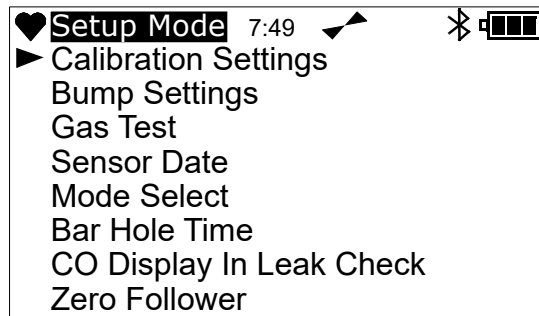

2. Press **POWER** to select the menu item. The **CO Display In Leak Check** screen appears with the cursor next to the current setting.

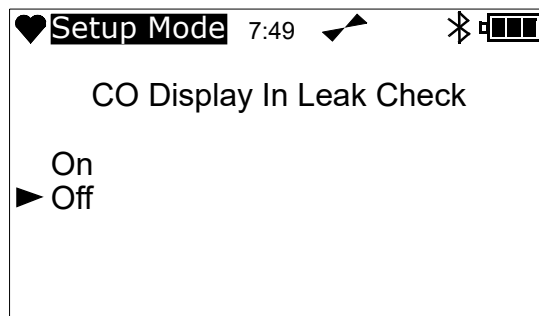

3. Press **AIR** or **RANGE** to scroll to the desired setting.
4. Press **POWER** to save the setting and return to the Setup Mode menu.
5. To exit Setup Mode:
 - a. Press **AIR** or **RANGE** to scroll to **Normal Operation**.
 - b. Press **POWER** to enter Normal Mode and begin the warmup sequence.

Turning Zero Follower On or Off

The **Zero Follower** setting is not intended for field adjustment. The default setting for most target gases is **ON**. The default setting for carbon dioxide channels and some configurations of F-sensor toxic gas channels is **OFF**.

NOTE: The O₂ and PID channels do not support this feature.

1. While in Setup Mode, press **AIR** or **RANGE** to scroll to **Zero Follower**.

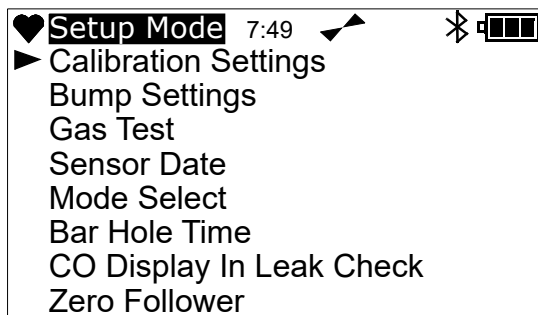

- Press **POWER** to select the menu item. The channel selection screen appears with only the first channel displayed.

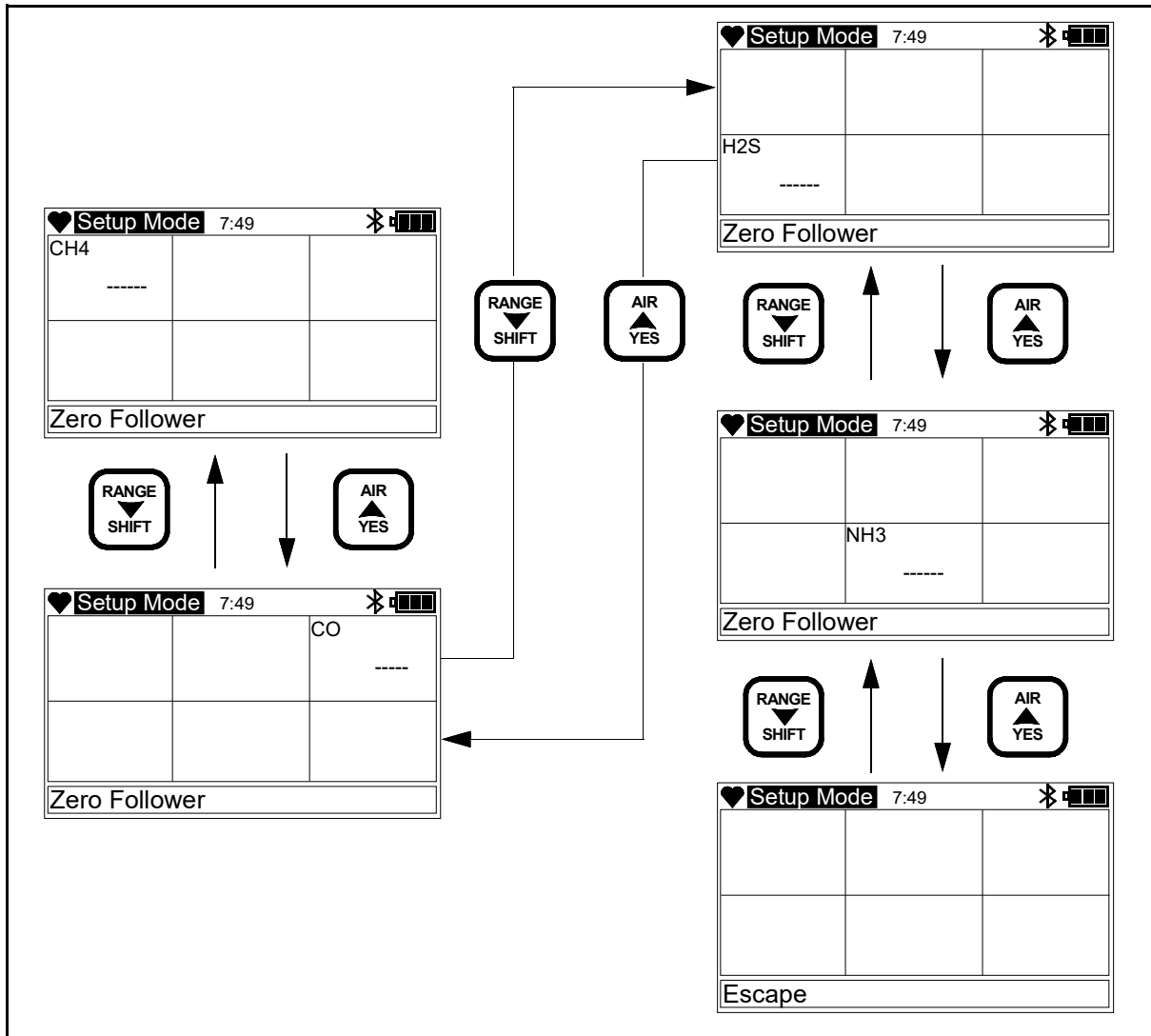

- Press **AIR** or **RANGE** to scroll to the desired channel.
- Press **POWER** to select the desired channel. The current **Zero Follower** setting for that channel begins flashing.

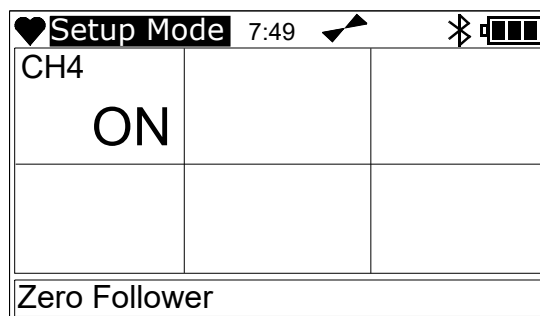

- Press **AIR** or **RANGE** to scroll to the desired setting.

6. Press **POWER** to save the setting.
7. To return to the Setup Mode menu, press **RANGE** until the **Escape** screen appears. Press **POWER** to select the menu item.
8. To exit Setup Mode:
 - a. Press **AIR** or **RANGE** to scroll to **Normal Operation**.
 - b. Press **POWER** to enter Normal Mode and begin the warmup sequence.

Turning Zero Suppression On or Off

The **Zero Suppression** setting is not intended for field adjustment. The default setting for each sensor is **On**. The following table lists the suppression value for each channel.

Sensor	Zero Suppression Value
Combustible Gas	2% LEL
O ₂	0.5% volume
H ₂ S	0.3 ppm
Cl ₂	0.18 ppm
ClF ₃	0.018 ppm
CO	2 ppm
CO ₂	0 ppm
GeH ₄	0.045 ppm
HCN	0.5 ppm
NH ₃	10 ppm
NO	6 ppm
NO ₂	0.90 ppm
O ₃	0.035 ppm
PH ₃	0.06 ppm
Si ₂ H ₆	0.9 ppm
SO ₂ (0 - 6.00 ppm)	0.35 ppm
SO ₂ (0 - 100 ppm)	0.4 ppm

1. While in Setup Mode, press **AIR** or **RANGE** to scroll to **Zero Suppression**.

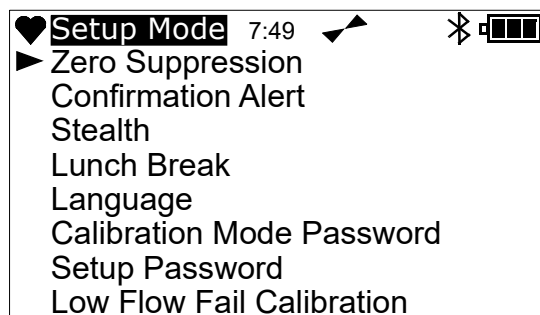

2. Press **POWER** to select the menu item. The channel selection screen appears with only the first channel displayed.

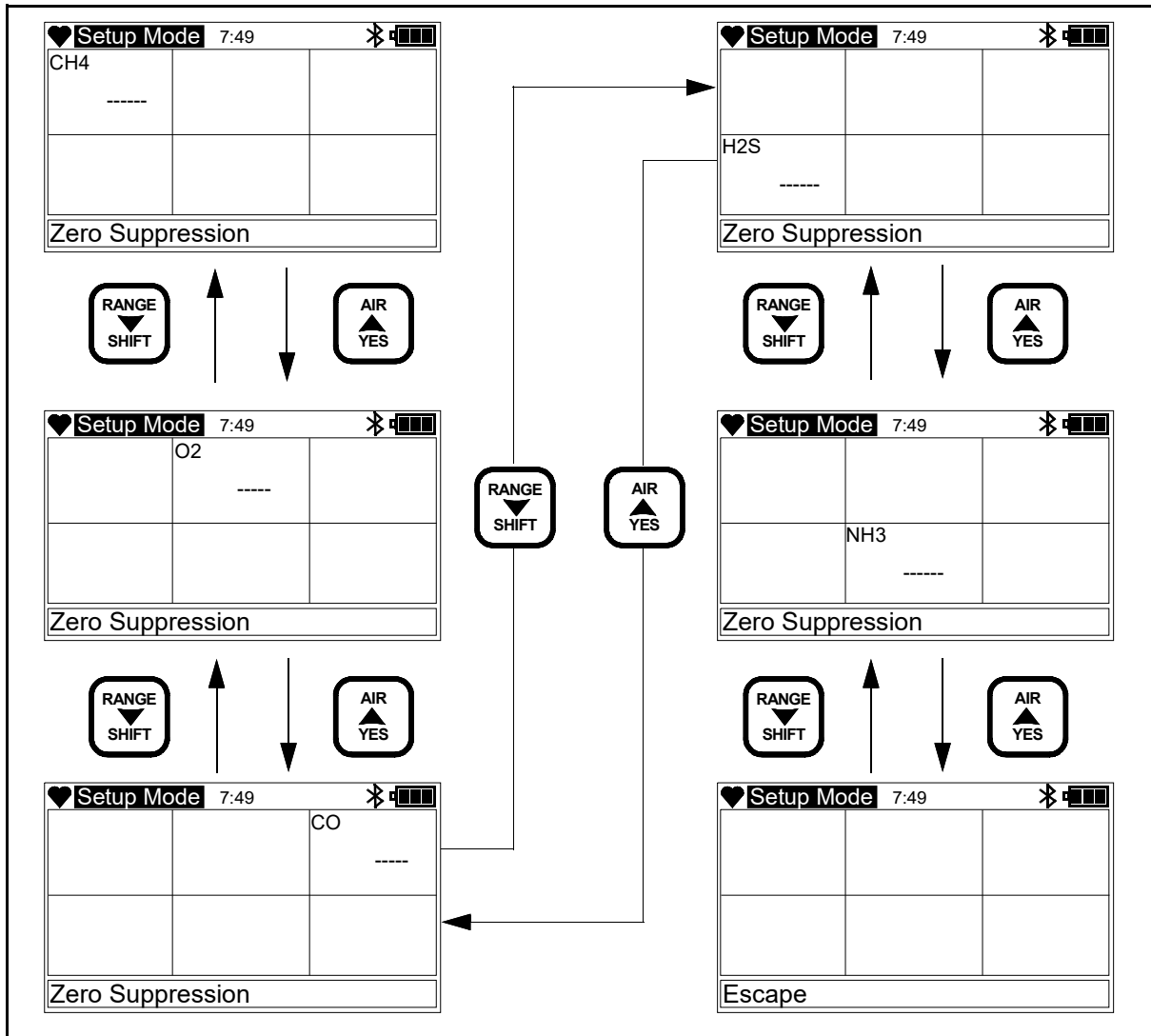

3. To view a different channel, press **RANGE** until the desired channel appears.
4. To change a channel's zero follower setting, press **POWER**. The current **Zero Suppression** setting for that channel begins flashing.

5. Press **AIR** or **RANGE** to switch the **Zero Suppression** setting from **On** to **Off**. Press **POWER** to save the setting.

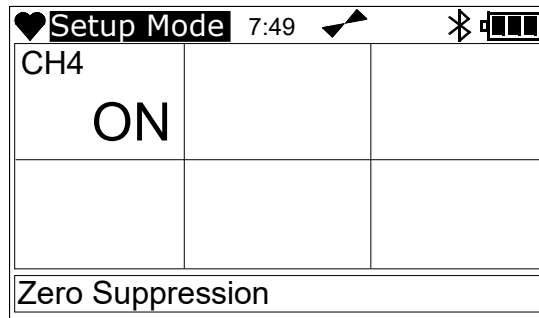

6. To return to the Setup Mode menu, press **AIR** or **RANGE** until the **Escape** screen appears. Press **POWER** to select the menu item.
7. To exit Setup Mode:
 - a. Press **AIR** or **RANGE** to scroll to **Normal Operation**.
 - b. Press **POWER** to enter Normal Mode and begin the warmup sequence.

Adjusting the Confirmation Alert Settings

Selecting the Beep Select Setting

Use this menu to select the confirmation alert setting. The options are detailed below.

- **Off** (factory setting): The EAGLE 3 does not sound a confirmation alert.
- **LED**: The EAGLE 3 flashes the LED arrays as often as defined by the **Beep Interval** parameter to verify that it is operating.
- **Buzzer**: The EAGLE 3 beeps as often as defined by the **Beep Interval** parameter to verify that it is operating.
- **LED And Buzzer**: The EAGLE 3 beeps and flashes the LED arrays as often as defined by the **Beep Interval** parameter to verify that the unit is operating.
- **Bump/Cal**: If a bump test or a calibration is due and **Bump/Cal Past Due Act** is set to **Confirm to Use** or **No Effect**, the EAGLE 3's LEDs flash as often as defined by the **Beep Interval** parameter to indicate a non-compliance. Once a successful bump test or calibration (depending on which is due) is done, the LEDs stop flashing.
- **Alarm Alert**: If the instrument goes into any gas alarm, the LEDs flash as often as defined by the **Beep Interval** parameter to indicate a non-compliance. Once a successful bump test or calibration is done, the LEDs stop flashing.
- **Bump/Cal/Alarm**: The LEDs flash to indicate a non-compliance if any of the following happens.
 - **Bump Past Due Act** is set to **Confirm to Use** or **No Effect** and a bump test is due (cleared by successful bump test).

- **Cal Past Due Act** is set to **Confirm to Use** or **No Effect** and a calibration is due (cleared by successful calibration).
- The instrument goes into any gas alarm (cleared by successful bump test or calibration).

1. While in Setup Mode, press **AIR** or **RANGE** to scroll to **Confirmation Alert**.

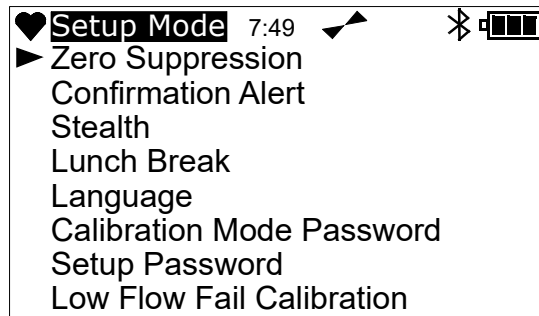

2. Press **POWER** to select the menu item. The Confirmation Alert menu appears.

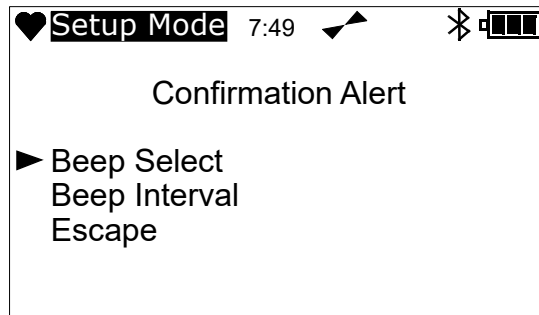

3. Press **AIR** or **RANGE** to scroll to **Beep Select**.

4. Press **POWER** to select the menu item. The **Beep Select** screen appears with the cursor next to the current setting.

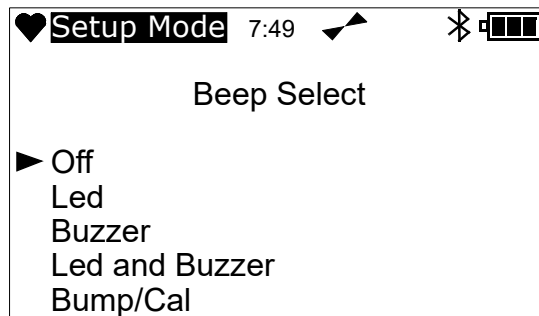

5. Press **AIR** or **RANGE** to scroll to the desired setting.

6. Press **POWER** to save the setting and return to the **Confirmation Alert** menu.

7. To return to the Confirmation Alert menu:

- Press **AIR** or **RANGE** to scroll to the **Escape** menu item.
- Press **POWER** to select the menu item.

8. To exit Setup Mode:
 - a. Press **AIR** or **RANGE** to scroll to **Normal Operation**.
 - b. Press **POWER** to enter Normal Mode and begin the warmup sequence.

Selecting the Beep Interval Setting

Use this menu to select one of the following beep intervals: 5 seconds, 10 seconds, 20 seconds, 30 seconds, 1 minute, 3 minutes, **5 minutes** (factory setting), 10 minutes, 20 minutes, and 30 minutes.

1. While in Setup Mode, press **AIR** or **RANGE** to scroll to **Confirmation Alert**.

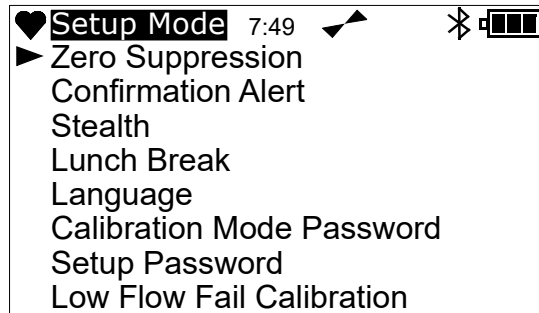

2. Press **POWER** to select the menu item. The Confirmation Alert screen appears.

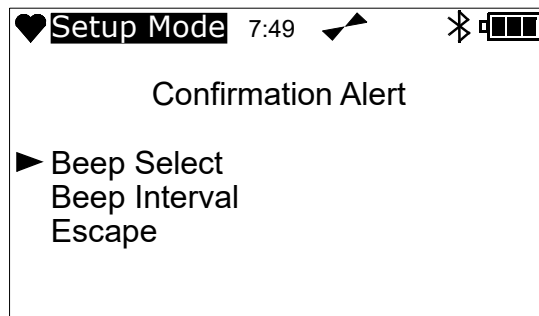

3. Press **AIR** or **RANGE** to scroll to **Beep Interval**.
4. Press **POWER** to select the menu item. The **Beep Interval** screen appears with the cursor next to the current setting.

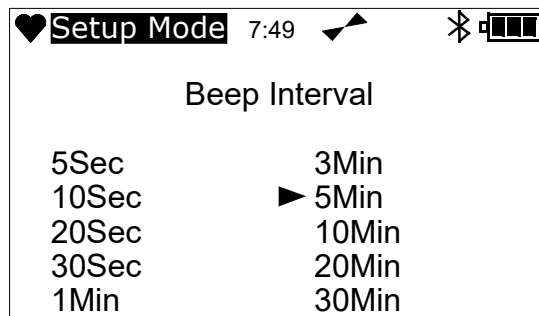

5. Press **AIR** or **RANGE** to scroll to the desired setting.
6. Press **POWER** to save the setting and return to the **Confirmation Alert** menu.

7. To return to the Confirmation Alert menu:
 - a. Press **AIR** or **RANGE** to scroll to the **Escape** menu item.
 - b. Press **POWER** to select the menu item.
8. To exit Setup Mode:
 - a. Press **AIR** or **RANGE** to scroll to **Normal Operation**.
 - b. Press **POWER** to enter Normal Mode and begin the warmup sequence.

Turning Stealth On or Off

On: The instrument's backlight, LEDs, and buzzer are disabled regardless of any alarm condition or the **Backlight Time** setting. An **S** appears at the top of the LCD to indicate when the unit's Stealth feature is active.

Off (factory setting): The instrument's backlight and LEDs operate normally.

1. While in Setup Mode, press **AIR** or **RANGE** to scroll to the **Stealth** menu item.

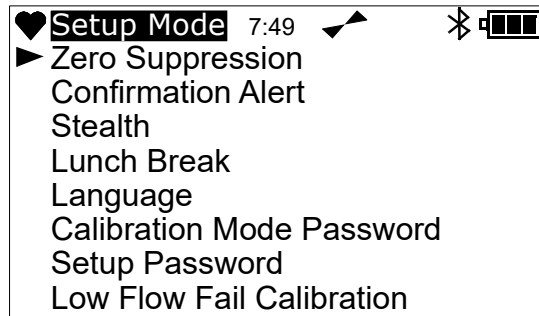

2. Press **POWER** to select the menu item. The **Stealth** screen appears with the cursor next to the current setting.

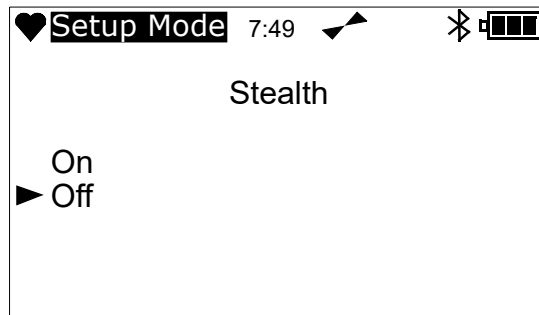

3. Press **AIR** or **RANGE** to move the cursor to the desired setting.
4. Press **POWER** to save the desired setting and return to Setup Mode.
5. To exit Setup Mode:
 - a. Press **AIR** or **RANGE** to scroll to **Normal Operation**.
 - b. Press **POWER** to enter Normal Mode and begin the warmup sequence.

Turning Lunch Break On or Off

On: The Resume Measurements Screen displays during warmup. From this screen, you can choose to continue accumulating TWA and PEAK readings and the time in operation from the last time the EAGLE 3 was used or start collecting new readings and reset the time in operation.

Off (factory setting): The EAGLE 3 automatically starts new TWA and PEAK reading collection and resets the time in operation at warmup.

1. While in Setup Mode, press **AIR** or **RANGE** to scroll to the **Lunch Break** menu item.

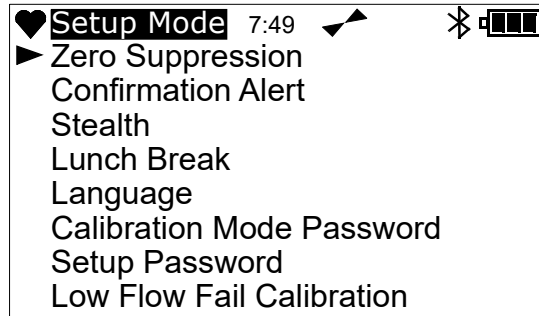

2. Press **POWER** to select the menu item. The **Lunch Break Screen** appears with the cursor next to the current setting.

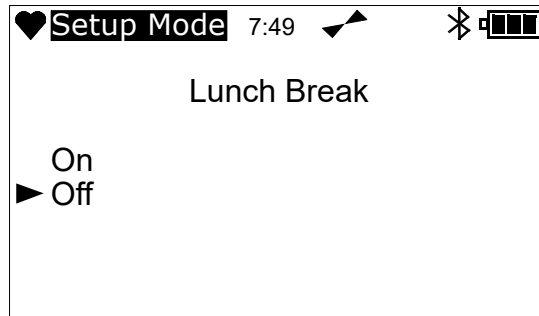

3. Press **AIR** or **RANGE** to move the cursor to the desired setting.
4. Press **POWER** to save the desired setting and return to Setup Mode.
5. To exit Setup Mode:
 - a. Press **AIR** or **RANGE** to scroll to **Normal Operation**.
 - b. Press **POWER** to enter Normal Mode and begin the warmup sequence.

Selecting the Language Setting

Use this menu to view and select the language for the EAGLE 3's interface. Currently, **English** (factory setting) is the only language option available.

NOTE: If a language other than English is selected, a prompt will appear during warmup to change the language back to English if desired.

1. While in Setup Mode, press **AIR** or **RANGE** to scroll to the **Language** menu item.

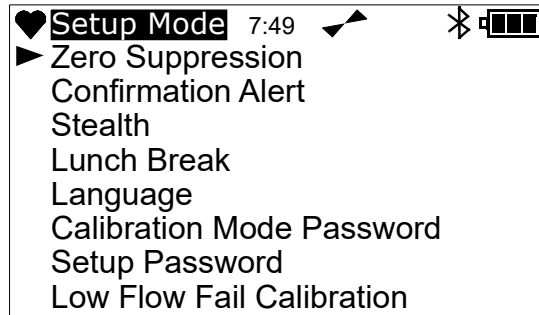

2. Press **POWER** to select the menu item. The **Language** screen appears with the cursor next to the current setting.

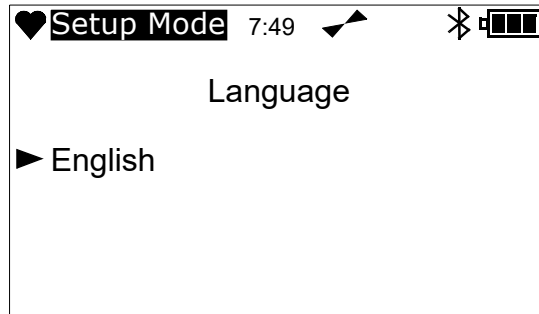

3. Press **AIR** or **RANGE** to scroll to the desired setting.
4. Press **POWER** to save the desired setting and return to Setup Mode.
5. To exit Setup Mode:
 - a. Press **AIR** or **RANGE** to scroll to **Normal Operation**.
 - b. Press **POWER** to enter Normal Mode and begin the warmup sequence.

Setting the Calibration Mode Password

On: The EAGLE 3 prompts you for a password when you enter Calibration Mode.

NOTE: If a calibration is past due, **Calibration Reminder** is set to **On**, and **Calibration Past Due Act** is set to **Must Calibrate**, a password will not be required to perform a calibration during warmup.

Off (factory setting): No password is required to enter Calibration Mode.

1. While in Setup Mode, press **AIR** or **RANGE** to scroll to **Calibration Mode Password**.

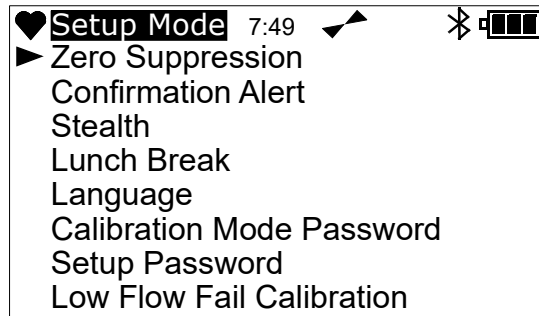

2. Press **POWER** to select the menu item. The **Calibration Mode Password** screen appears with the cursor next to the current setting.

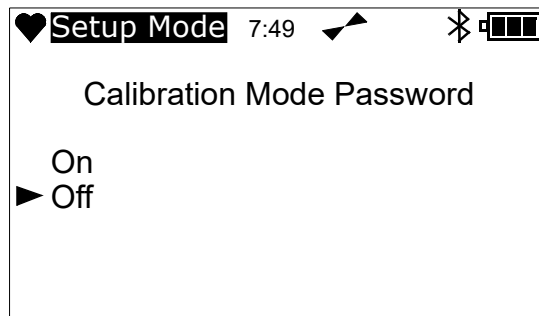

3. Press **AIR** or **RANGE** to scroll to the desired setting.
4. Press **POWER** to save the desired setting and proceed to the Enter Password screen. The **Calibration Mode Password** screen appears, displaying the current password (factory set to **0000**) with the first number flashing.

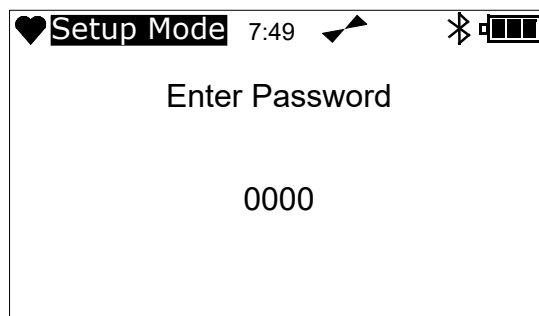

5. Press **AIR** or **RANGE** to increase or decrease the first number.
6. Press **POWER** to save the current number and advance to the next number.
7. Repeat Step 5 to select the remaining numbers. After entering the last number, the password is saved and the instrument returns to the Setup Mode.
8. To exit Setup Mode:
 - a. Press **AIR** or **RANGE** to scroll to **Normal Operation**.
 - b. Press **POWER** to enter Normal Mode and begin the warmup sequence.

Setting the Setup Password

Use the Setup Password menu to enable and save a password or to disable the setting.

On: A password will be required to enter Setup Mode.

Off (factory setting): No password is required to enter Setup Mode.

1. While in Setup Mode, press **AIR** or **RANGE** to scroll to **Setup Password**.

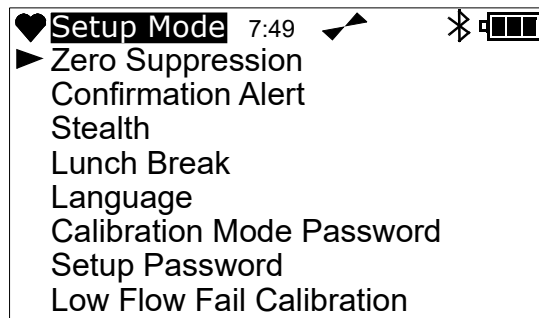

2. Press **POWER** to select the menu item. The **Setup Password** screen appears with the cursor next to the current setting.



3. Press **POWER** to save the desired setting and proceed to the Setup Password screen.

- The **Setup Password** screen appears, displaying the current password (factory set to **0000**) with the first number flashing. Press **AIR** or **RANGE** to increase or decrease the first number. Press **POWER** to save the current number and advance to the next number.

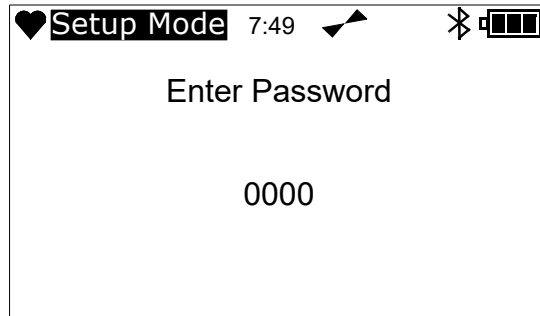

- Repeat Step 4 to select the remaining numbers. After entering the last number, the password is saved and the instrument returns to the Setup Mode.
- To exit Setup Mode:
 - Press **AIR** or **RANGE** to scroll to **Normal Operation**.
 - Press **POWER** to enter Normal Mode and begin the warmup sequence.

Performing a Low Flow Fail Calibration

Use **Low Flow Fail Calibration** if the instrument repeatedly goes into low flow alarm and all other recommendations in the Troubleshooting section have been attempted.

- While in Setup Mode, press **AIR** or **RANGE** to scroll to **Low Flow Fail Calibration**.

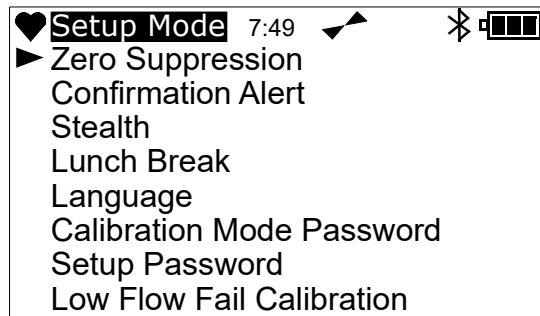

- Press **POWER** to select the menu item. The following prompt appears.

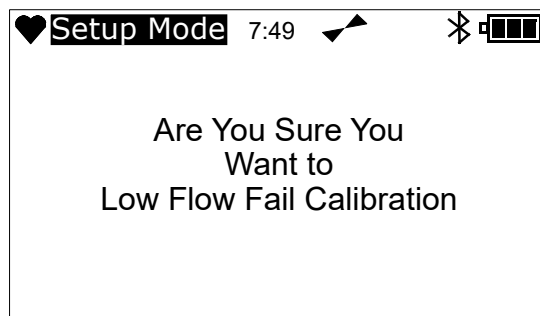

3. Press **POWER** to begin the pump stabilization.

To return to the Setup Mode menu without performing a Low Flow Fail Calibration, press **DISPLAY**.

4. The pumps will turn off to stabilize and the following sequence will be displayed.

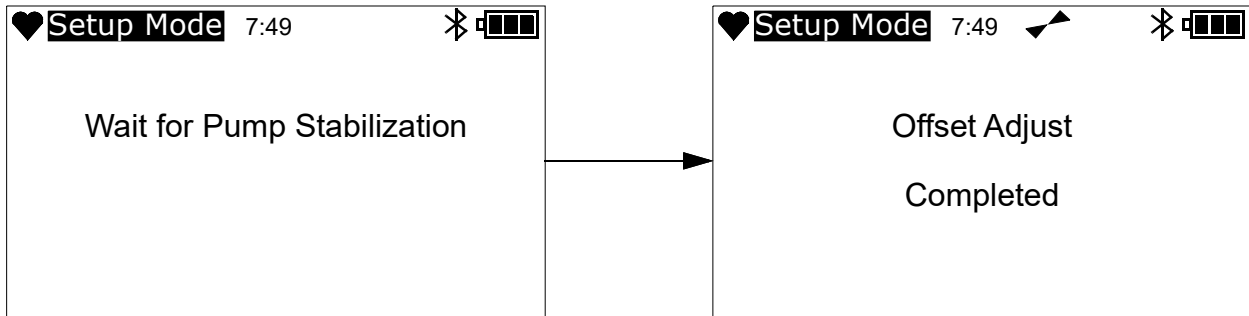

5. Once the offset adjustment is complete, the pump starts up again. Connect a flowmeter with a valve to the inlet of the instrument and adjust it to 1.06 SCFH for Transformer versions or 0.95 SCFH for all other versions. This will be the low flow setpoint. You do not need to adjust anything at the instrument.

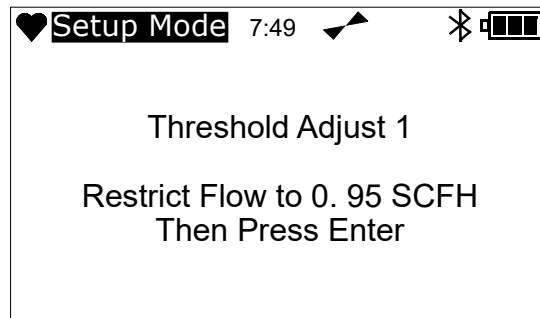

6. Press **POWER** to confirm the calibration and return to Setup Mode. Disconnect the flowmeter from the EAGLE 3.
7. To exit Setup Mode:
 - a. Press **AIR** or **RANGE** to scroll to **Normal Operation**.
 - b. Press **POWER** to enter Normal Mode and begin the warmup sequence.

Viewing the Software Version

Use this menu item to view the main PCB's software version, the loaded PID gas list, and any sensor board version.

1. While in Setup Mode, press **AIR** or **RANGE** to scroll to **Software Version**.

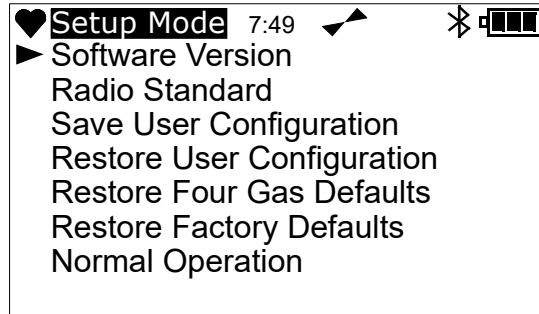

2. Press **POWER** to select the menu item. The **Main Board Version** screen appears.

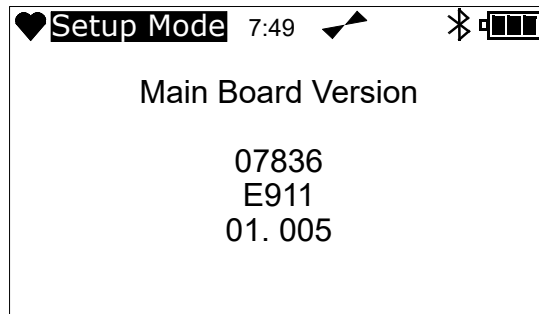

3. Press **POWER** to cycle to the next version screen.
4. Press **DISPLAY** to return to the Setup Mode menu.
5. To exit Setup Mode:
 - a. Press **AIR** or **RANGE** to scroll to **Normal Operation**.
 - b. Press **POWER** to enter Normal Mode and begin the warmup sequence.

Viewing the Radio Standard

Use this menu to view the Radio Standard.

1. While in Setup Mode, press **AIR** or **RANGE** to scroll to **Radio Standard**.

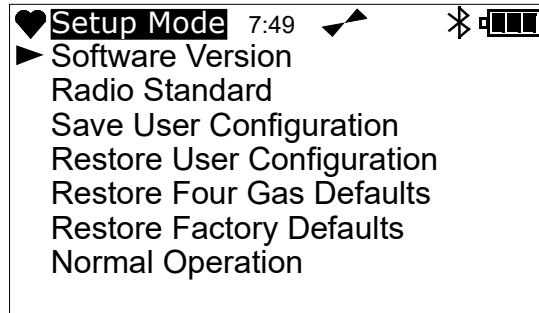

2. Press **POWER** to select the menu item. The **Radio Standard** screen appears.

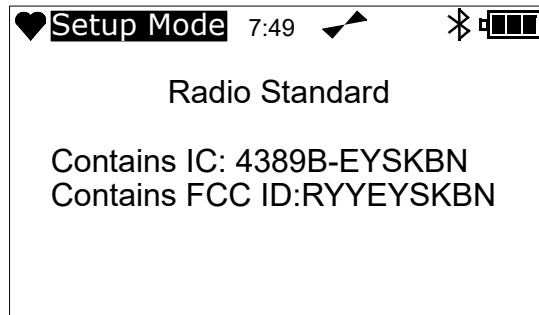

3. Press **POWER** to return to the Setup Mode menu.
4. To exit Setup Mode:
 - a. Press **AIR** or **RANGE** to scroll to **Normal Operation**.
 - b. Press **POWER** to enter Normal Mode and begin the warmup sequence.

Saving User Configuration

Use this menu to save the current configuration as the default user configuration. Saving a new configuration will overwrite any previously saved user configuration.

Saved user configurations can be restored using the **Restore User Configuration** function described in the next section.

1. While in Setup Mode, press **AIR** or **RANGE** to scroll to **Save User Configuration**.

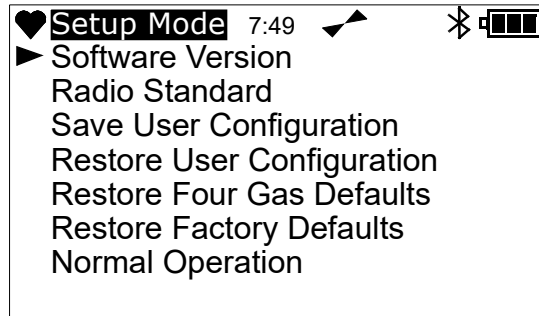

2. Press **POWER** to select the menu item. The following screen appears.

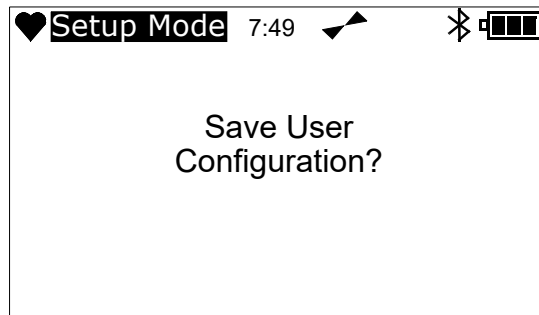

3. Press **POWER** or **AIR** to proceed to the confirmation screen.

To return to the Setup Mode menu without saving the current configuration as the default user configuration, press **DISPLAY**.

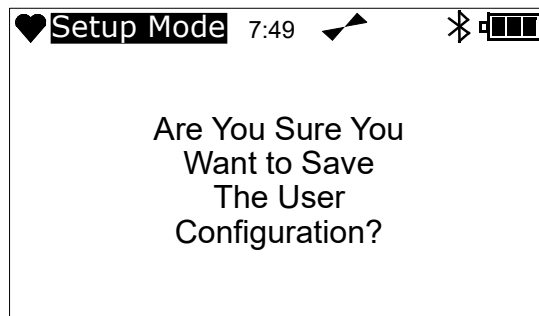

4. Press **POWER** or **AIR** to save user configuration and return to the Setup Mode menu.

To return to the Setup Mode menu without saving the user configuration, press **DISPLAY**.

5. To exit Setup Mode:
 - a. Press **AIR** or **RANGE** to scroll to **Normal Operation**.
 - b. Press **POWER** to enter Normal Mode and begin the warmup sequence.

Restoring User Configuration

Use this menu to restore the current settings to the saved user configuration (saved in the previous menu item, **Save User Configuration**).

1. While in Setup Mode, press **AIR** or **RANGE** to scroll to **Restore User Configuration**.

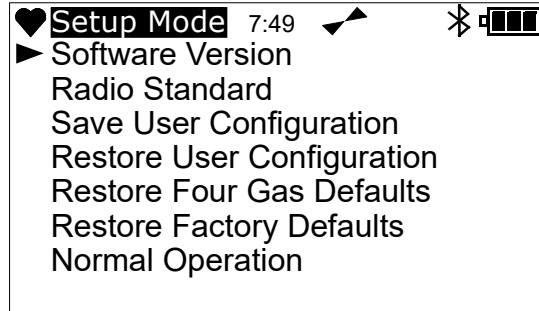

2. Press **POWER** to select the menu item. The following screen appears.

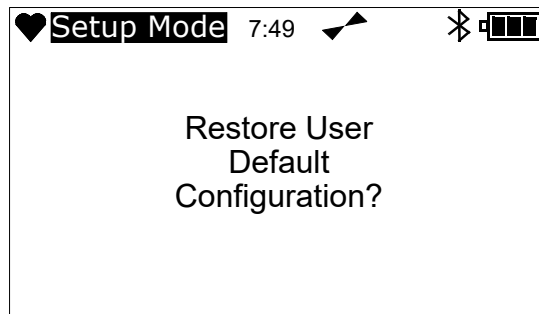

3. Press **POWER** or **YES** to proceed to the confirmation screen.

To return to the Setup Mode menu without restoring the four gas default alarm settings, press **DISPLAY**.

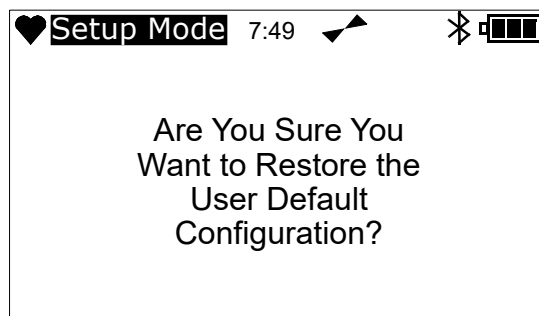

4. Press **POWER** or **YES** to restore the current configuration to the saved user configuration and return to the Setup Mode menu.
To return to the Setup Mode menu without restoring the current configuration, press **DISPLAY**.
5. To exit Setup Mode:
 - a. Press **AIR** or **RANGE** to scroll to **Normal Operation**.
 - b. Press **POWER** to enter Normal Mode and begin the warmup sequence.

Restoring Four Gas Defaults

Use this menu to restore the current settings to the four gas default configuration. This reverts all channel settings, alarm points, and other target-gas specific parameters to their four gas default settings.

WARNING: *When the EAGLE 3 is restored to its default configuration, the zero and span values for each channel are reset. All active channels must be recalibrated if the EAGLE 3 is restored to its default configuration.*

1. While in Setup Mode, press **AIR** or **RANGE** to scroll to **Restore Four Gas Defaults**.

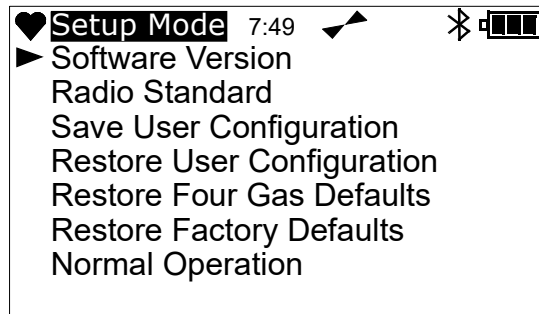

2. Press **POWER** to select the menu item. The following screen appears.

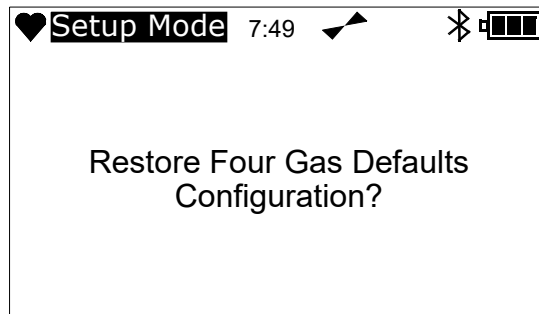

3. Press **POWER** or **YES** to proceed to the confirmation screen.

To return to the Setup Mode menu without restoring the current configuration, press **DISPLAY**.

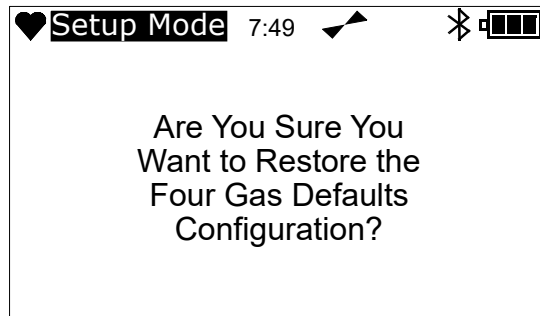

4. Press **POWER** or **YES** to restore the current configuration to the four gas default configuration and return to the Setup Mode menu.

To return to the Setup Mode menu without restoring the current configuration, press **DISPLAY**.

5. To exit Setup Mode:

- a. Press **AIR** or **RANGE** to scroll to **Normal Operation**.
- b. Press **POWER** to enter Normal Mode and begin the warmup sequence.

Restoring Factory Defaults

Each of the EAGLE 3 setup parameters, such as the auto calibration values or parameters in Setup Mode, has a factory default setting. The **Restore Factory Defaults** menu item in Setup Mode can be used to return all setup parameters to their default settings. Restoring all setup parameters to their default settings can be useful if selected settings produce unintended issues and returning the EAGLE 3 to its original configuration would help with troubleshooting.

The standard default gas configuration is LEL/O₂/H₂S/CO. If any channels have been turned off or added to the EAGLE 3, the unit must be re-setup to the desired gas combination after it is restored to its default configuration.

WARNING: *When the EAGLE 3 is restored to its default configuration, the zero and span values for each channel are reset. All active channels must be recalibrated if the EAGLE 3 is restored to its default configuration.*

1. While in Setup Mode, press **AIR** or **RANGE** to scroll to **Restore Factory Defaults**.

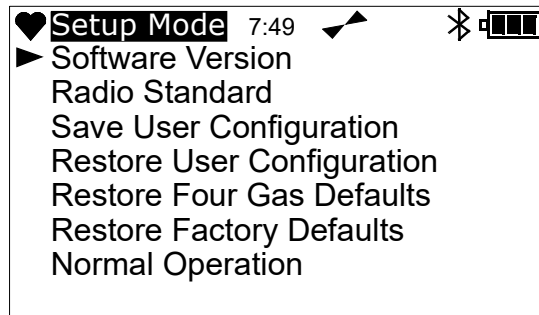

2. Press **POWER** to select the menu item. The following screen appears.

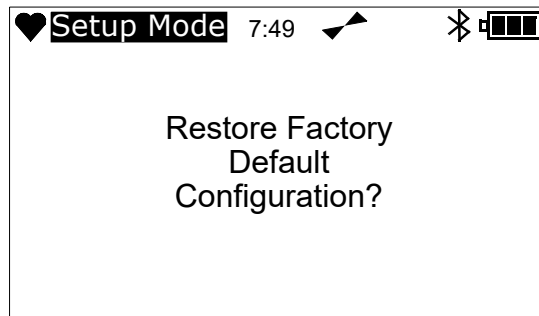

3. Press **POWER** or **YES** to proceed to the confirmation screen.

To return to the Setup Mode menu without restoring the factory defaults, press **DISPLAY**.

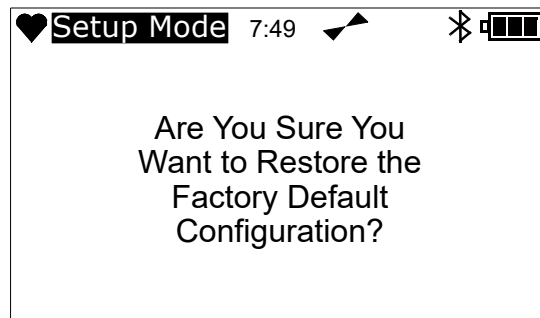

4. Press **POWER** or **YES** to restore the current configuration to the factory configuration and return to the Setup Mode menu.

To return to the Setup Mode menu without restoring the current configuration, press **DISPLAY**.

5. To exit Setup Mode:

- a. Press **AIR** or **RANGE** to scroll to **Normal Operation**.
- b. Press **POWER** to enter Normal Mode and begin the warmup sequence.

Exiting Setup Mode (Normal Operation)

1. While in Setup Mode, press **AIR** or **RANGE** to scroll to **Normal Operation**.

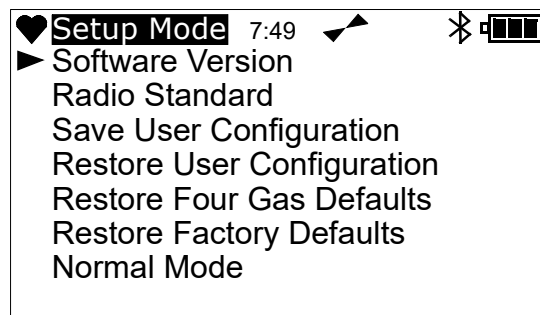

2. Press **POWER** to enter **Normal Operation** and begin the warmup sequence.

Appendix B: Calibrating with a Sample Bag

Overview

The EAGLE 3 can be calibrated with a gas bag calibration kit instead of a demand flow regulator kit. This appendix describes how to use a sample bag calibration kit to calibrate the EAGLE 3. A parts list at the end of this appendix lists spare parts for the calibration kit.

Calibration Supplies and Equipment

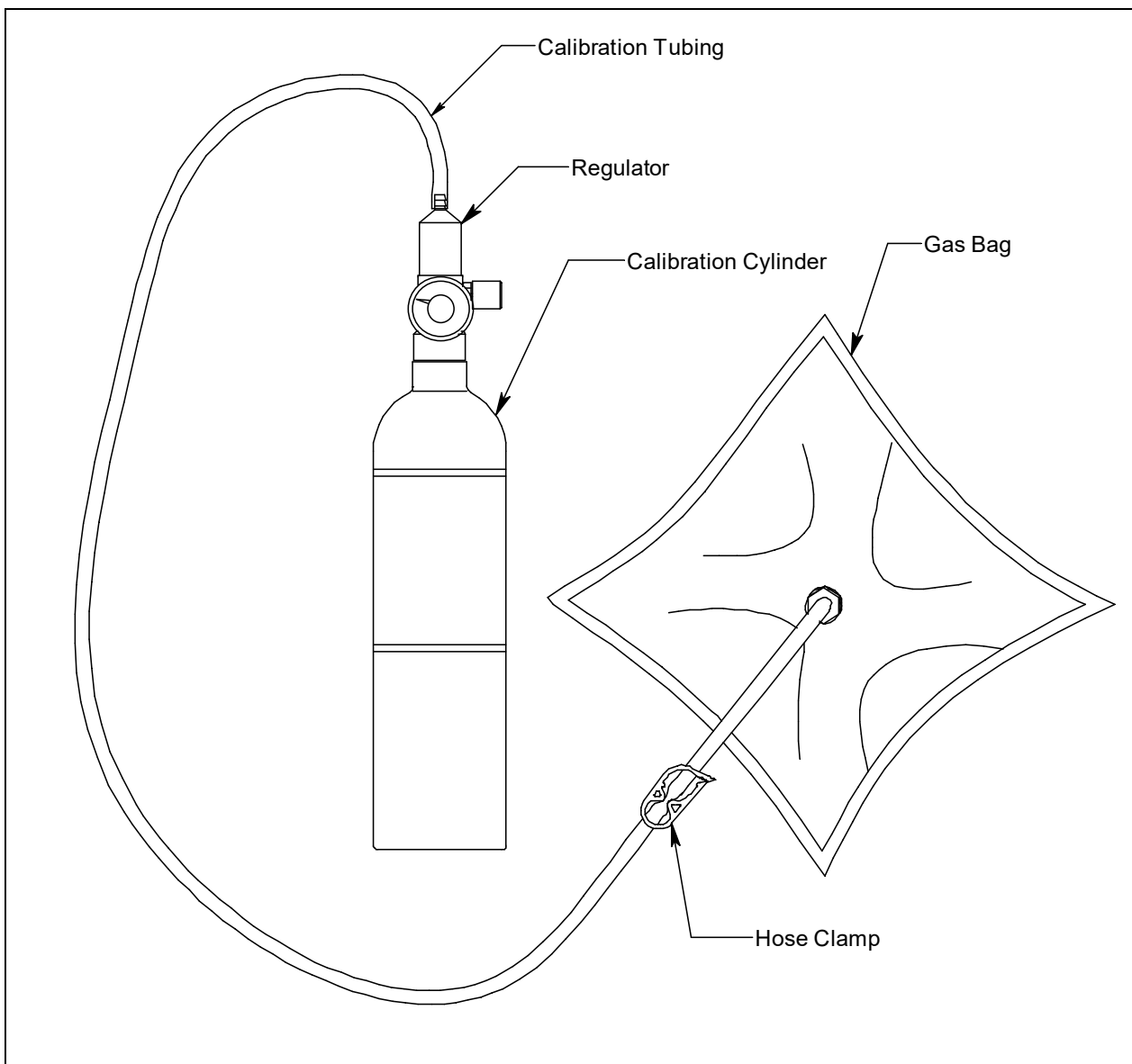

Figure 22: Gas Bag Calibration Kit

To calibrate the EAGLE 3, you will need:

- Known calibrating samples of the gases being detected. The combustible and toxic gas samples should have concentrations between 10 and 50% of the full scale value. For example, if you are calibrating the catalytic combustible gas channel, your calibration cylinder should have a combustible gas concentration between 10% LEL and 50% LEL. An oxygen-free source, such as 100% nitrogen is recommended for setting the oxygen zero.

NOTE: The catalytic combustible channel can be set up for and calibrated to a number of different combustible gases. See “Configuring the Gases (Configure Gases)” on page 123 for instructions. Be sure that you are using an appropriate calibration cylinder for the target gas of the catalytic combustible channel.

CAUTION: *When using auto calibration with the standard 4-gas EAGLE 3, although the EAGLE 3 can be calibrated with an oxygen concentration of up to 19.5%, RKI Instruments, Inc. recommends that the multi-gas cylinder have an oxygen concentration in the range of 10% - 16% oxygen.*

- A gas collection bag with hose clamp
- A 6 LPM fixed-flow regulator or a dispensing valve

WARNING: *RKI Instruments, Inc. recommends that you dedicate a regulator for use with chlorine (Cl₂) gas and that you do not use that dedicated regulator for any other gases, particularly hydrogen sulfide (H₂S).*

- Calibration tubing

Follow the instructions in “Performing a Calibration” on page 87 for calibrating the instrument. When the instructions call for applying gas to the instrument, perform the following steps:

1. Slide the tubing clamp onto the tubing and connect the tubing to the sample bag’s inlet fitting. Leave the clamp unclamped for now.
2. Install the probe on the EAGLE 3 inlet fitting. Make sure the probe is complete with internal O-ring and membrane and that the two halves of the probe are tightened firmly together to avoid leaks that can affect the calibration. See Figure 18 on page 100 for an illustration of the internal parts of the probe.
3. Connect the gas bag tubing to the regulator’s or dispensing valve’s hose barb fitting.
4. Fill the gas collection bag by screwing the fixed flow regulator or dispensing valve onto the calibration cylinder and turning the knob counterclockwise.
5. Allow the gas to dispense until the gas collection bag is a little over half full.
6. Turn the knob clockwise to stop the gas flow, clamp down the hose clamp and remove the regulator or dispensing valve from the cylinder.
7. Disconnect the tubing from the regulator or dispensing valve.

8. Open the hose clamp on the gas bag tubing.
9. Connect the tubing from the gas bag to the rigid tube on the probe.

Sample Bag Calibration Parts List

Table 18: Sample Bag Calibration Parts List

Part Number	Description
06-1248RK-03	Calibration kit tubing, 3 foot length
81-0090RK-01	Calibration cylinder, 3-gas mix, LEL/Oxygen/CO, 34 liter steel
81-0154RK-04	Calibration cylinder, 4-gas mix, LEL/Oxygen/CO/H ₂ S, 34 liter aluminum
81-1001RK	Dispensing valve, for 17/34 liter steel cylinders (cylinders with external threads)
81-1051RK-60	Regulator with gauge and knob, 6 LPM, for 34 liter aluminum/58 liter/103 liter cylinders (cylinders with internal threads)
81-1126RK	Gas bag with clamp and hose barb, 9" x 9", 2 liter
81-5302RK-LV	Calibration kit, for LEL/Oxy/CO unit, w/gas bag, 34 Liter
81-5401RK-LV	Calibration kit, for LEL/Oxy/H ₂ S/CO unit, w/gas bag, 34 Liter

Appendix C: PID Sensors

Overview

The PID (photo ionization detector) sensors are used for applications where high sensitivity is needed to monitor ppm levels of VOCs (volatile organic compounds). This appendix describes the EAGLE 3's PID sensors and includes instructions to use an EAGLE 3 that has a PID sensor installed. It also includes instructions to maintain and replace a PID sensor.

Table 19: PID Sensor Specifications

Target Gas	Sensor Type	Detection Range	Reading Increment	Alarm 1 Factory Setting	Alarm 2 Factory Setting
VOCs (Isobutylene Calibration Standard)	Low Range	0 - 40.000 ppm	0.001 ppm	5.000 ppm	10.000 ppm
	High Range	0 - 4000 ppm	1 ppm	400 ppm	1000 ppm

Description

Two types of PID sensors can be used with the EAGLE 3, a low range (high sensitivity) sensor and a high range (low sensitivity) sensor. The PID sensor is installed in a single sensor flow chamber which is located in the area next to the standard 4-sensor flow chamber. This area can accommodate up to three single sensor flow chambers. Figure 23 below illustrates a typical PID sensor location. The PID flow chamber may also be installed in one of the other two sensor chamber locations depending on the particular version of the EAGLE 3. Some PID instrument configurations do not include the LEL sensor chamber.

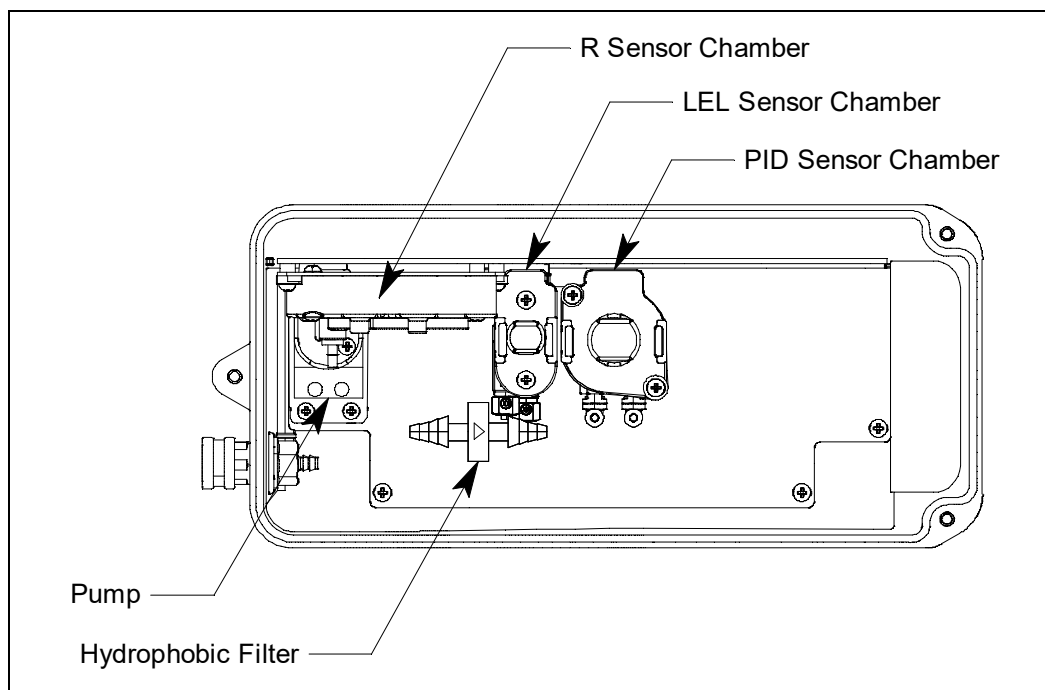

Figure 23: Typical PID Sensor Location

PID Sensor

The PID sensor is a cylindrical sensor with a diffusion opening on the front and 3 pins on the back. The pins plug into the F sensor base, which in turn plugs into the adapter PCB seated in the sensor retainer. The sensor retainer is secured to the flow block with 2 screws.

PID Probe

Several of the gases that can be monitored with a PID are easily absorbed in the EAGLE 3's standard sample hose and standard probe. One example of this is styrene. Because of this, RKI Instruments, Inc. recommends that you install the probe directly to the inlet fitting when monitoring for gas with the PID sensor.

VOC Zero Filter

A VOC zero filter is included as standard with EAGLE 3s that include a low range PID sensor.

The VOC zero filter scrubs out low levels of VOC gases using charcoal. Use the VOC zero filter when performing an air adjust on a PID sensor in an area that may have a low-level VOC background.

The filter comes with a tubing stub and plug on each end. Both plugs must be removed before using the filter and must be reinstalled for storage. The filter does not have a preferred flow direction.

When used with a CO₂ scrubber, the VOC zero filter gets connected to the probe and the CO₂ scrubber gets connected to the VOC zero filter. See “Performing a Demand Zero for Carbon Dioxide Sensors” on page 228 for more instructions.

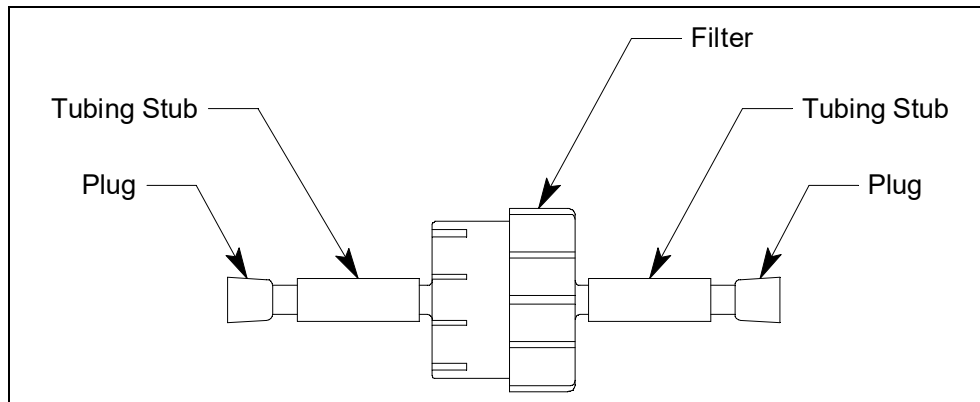

Figure 24: VOC Zero Filter

Start Up and Normal Operation

For instructions to warmup and use an EAGLE 3 that includes a PID sensor, reference “Start Up” on page 30, “Normal Mode Operation” on page 43, and “Alarms” on page 52. Follow these instructions keeping the following special considerations in mind:

- If it is necessary to use a sample hose for any reason, you must use the Teflon-lined hose that is supplied with the PID instrument. A 5 foot hose is supplied as standard. 10, 15, and 20 foot hoses are also available. 20 feet is the maximum hose length available for the Teflon-lined hose. See page 211 for ordering information.
- If your EAGLE 3 is a multigas unit that is used for monitoring of combustible gases in the % LEL range, the PID channel will indicate an upscale reading if one of a variety of combustible gases is present. If % LEL concentrations of one of these combustible gases is present, the PID channel may indicate an overscale reading.
- If concentrations of methane greater than 10% LEL are present in the monitoring environment, the PID channel's reading will be suppressed.
- The PID sensor will also respond to H₂S, so if H₂S is present, the PID channel may indicate an upscale reading depending on the concentration present.

The standard calibration for a PID channel is to isobutylene. A PID channel can be factory setup for and calibrated to other gases. Consult with RKI Instruments, Inc. for other available PID configurations and to specify the desired PID configuration when a unit is ordered.

It is possible to temporarily configure a PID channel for a target gas other than the factory setting in Display Mode. See the next section, PID Relative Response Feature, for instructions to use this feature.

Performing a Demand Zero for Low Range PID Sensors

1. If you suspect any low-level VOC background in the area, you must install the VOC zero filter before performing a demand zero.
 - a. Remove the plug from each end of the VOC zero filter.
 - b. Attach the VOC zero filter to the probe. The filter does not have a preferred flow direction.
 - c. If your instrument also has a 0-10,000 ppm or 0-5 %vol CO₂ sensor, remove the black caps from the CO₂ scrubber and connect its fitting to the VOC zero filter.

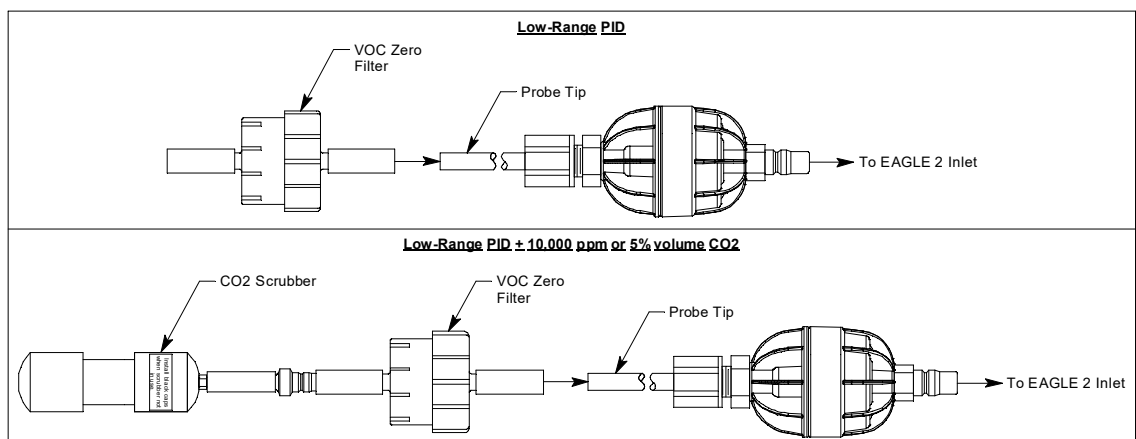

- d. Let the instrument draw through the filter(s) for 1 minute.
2. Press and hold the AIR ▲YES button. The LCD prompts you to continue holding the AIR ▲YES button and the buzzer will pulse.

3. Continue to hold the AIR ▲YES button until the LCD prompts you to release it.
4. If you used a CO₂ scrubber, remove it from the VOC filter and reinstall the black caps.
5. Remove the VOC zero filter from the probe and reinstall the plugs.

PID Relative Response Feature

The relative response feature enables you to change the PID sensor's response to gas on the fly so that the PID channel is roughly calibrated to an alternate gas. This is done by temporarily changing the gas configuration of the PID channel. You can select from a list of gases with responses relative to the configured gas, normally isobutylene, is programmed into the EAGLE 3's memory. For example, if the PID channel is setup for and calibrated to isobutylene (IBL), you can select isopropyl alcohol (IPA) from a gas list accessible from the PID Relative Response Screen in Display Mode so that the PID channel responds to gas as if it were calibrated to isopropyl alcohol. The EAGLE 3 will clear the gas configuration change when it is turned off and will return to the programmed configuration when it is turned on again.

The gas list for the relative response feature includes several pre-defined gases. Because of normal variation between sensors, these relative response factors are typical factors. If you use this feature, the response to the selected gas will not be as accurate as it would be if you configured and calibrated the PID channel to the target gas.

For maximum accuracy, configure and calibrate the EAGLE 3's PID channel to the desired target gas.

PID Sensor Relative Response Screen in Display Mode

To use the relative response feature for the PID sensor, enter Display Mode and select the desired gas as described below:

1. With the EAGLE 3 in Normal Mode, press the **DISPLAY** button repeatedly until you arrive at the PID Sensor Relative Response Screen.

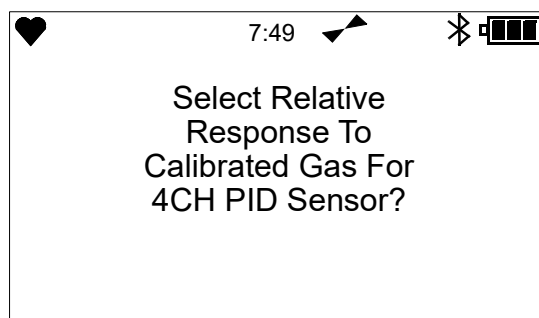

2. With the PID Sensor Relative Response Screen displayed, press **AIR**.

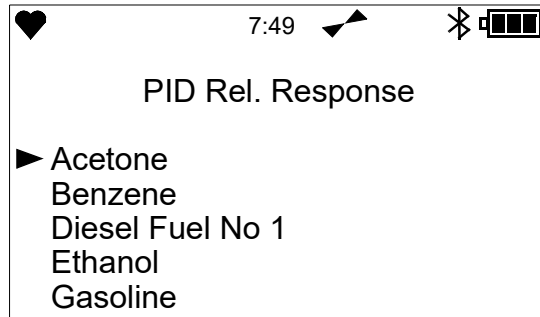

There are multiple screens of gases. The following is the complete list of factory defined gases along with their detection ranges, low alarm, high alarm, STEL, and TWA settings. Table 20 is a list of the low range values and Table 21 is a list of the high range values.

Table 20: Low Range Relative Response Gas List

Target Gas	Detection Range (ppm)	Alarm 1 Factory Setting (ppm)	Alarm 2 Factory Setting (ppm)	STEL (ppm)	TWA (ppm)
Acetone	0 - 24.00	5.00	7.50	OFF	OFF
Benzene	0 - 20.00	0.50	2.50	2.50	0.50
Diesel Fuel NO 1	0 - 32.00	2.00	3.00	OFF	OFF
Ethanol	0 - 320.00	10.0	15.0	OFF	OFF
Gasoline	0 - 40.00	3.00	5.00	OFF	OFF
Isobutylene	0 - 40.00	4.30	6.00	OFF	OFF
Isopropanol	0 - 160.00	2.0	4.0	OFF	OFF
JP-5 Fuel	0 - 24.00	1.40	2.10	OFF	OFF
Methyl Ethyl Ketone	0 - 32.00	2.00	3.00	OFF	OFF
Toluene	0 - 20.00	0.50	1.50	OFF	OFF
N-Hexane	0 - 160.00	5.0	10.0	OFF	OFF
Propylene	0 - 40.00	5.00	7.50	OFF	OFF
Styrene	0 - 16.00	0.20	0.40	OFF	OFF
Tetrachloro-ethylene	0 - 24.00	0.24	1.00	OFF	OFF
Trichloro-ethylene	0 - 24.00	0.50	1.00	OFF	OFF
Vinyl Chloride	0 - 80.00	1.0	5.0	5.0	1.0
PID	0 - 40.00	OFF	OFF	OFF	OFF

Table 21: High Range Relative Response Gas List

Target Gas	Detection Range (ppm)	Alarm 1 Factory Setting (ppm)	Alarm 2 Factory Setting (ppm)	STEL (ppm)	TWA (ppm)
Acetone	0 - 800	500	750	750	500
Benzene	0 - 800	50	250	OFF	OFF
Diesel Fuel NO 1	0 - 1200	200	300	OFF	200
Ethanol	0 - 12000	1000	1500	OFF	1000
Gasoline	0 - 1600	300	500	500	300
Isobutylene	0 - 1600	400	600	60	42
Isopropanol	0 - 4000	200	400	400	200
JP-5 Fuel	0 - 800	140	210	OFF	14
Methyl Ethyl Ketone	0 - 1200	200	300	300	200
Toluene	0 - 800	50	150	150	50
N-Hexane	0 - 4000	500	1000	1000	500
Propylene	0 - 2000	500	750	OFF	500
Styrene	0 - 400	20	40	40	20
Tetrachloro-ethylene	0 - 800	25	100	100	25
Trichloro-ethylene	0 - 800	50	100	100	50
Vinyl Chloride	0 - 3200	100	500	OFF	OFF
PID	0 - 4000	OFF	OFF	OFF	OFF

The last choice in each list, PID, can be defined by the user and loaded in the EAGLE 3 using the EAGLE 3 Maintenance Data Loader Program. See the EAGLE 3 Maintenance Data Loader Program Operator's Manual.

- Use the **AIR** or **RANGE** button to move the cursor next to the desired gas.
- Press **POWER**. The PID channel will be configured to the selected gas and the EAGLE 3 will proceed to the STEL Screen. This configuration will be in force until either a different gas is selected in Display Mode or the unit is turned off.

PID Calibration

See "Chapter 5: Calibration Mode" on page 79 for calibration instructions. A 5-gas mix can be used to calibrate an instrument that includes the standard 4 gases and a high-range 10.6 eV PID sensor.

Maintenance

The PID sensor includes user-serviceable parts. They are the lamp and the electrode stack. The following sections include troubleshooting instructions as well as procedures for cleaning the lamp, replacing the lamp, replacing the electrode stack, and replacing the PID sensor.

CAUTION: *After the EAGLE 3 case is opened, check that all pump tubing is securely connected and there are no kinks in the lines before securing the top case.*

Troubleshooting

The troubleshooting table describes symptoms, probable causes, and recommended action for problems you may encounter with the PID sensor.

Symptoms	Probable Causes	Recommended Action
<ul style="list-style-type: none">The PID sensor fails to calibrate.	<ul style="list-style-type: none">The auto calibration values may not match the cylinder gas concentration (auto calibration only).The sample gas is not reaching the sensor because of a bad connection.The calibration cylinder may be out of gas or is outdated.The lamp may need to be cleaned.The electrode stack may need to be replaced.	<ol style="list-style-type: none">Make sure the EAGLE 3 has been properly set up for calibration.Check all calibration tubing for leaks or for any bad connections.Verify that the calibration cylinder contains an adequate supply of sample.Clean the lamp.Replace the electrode stack.If the difficulties continue, contact RKI Instruments, Inc. for further instruction.

Cleaning the PID Sensor's Lamp

Clean the lamp if you notice a significant drop in sensitivity from one scheduled calibration to another or if you are not able to calibrate the PID channel. See the page 211 for lamp cleaning kit ordering information. The lamp cleaning kit includes the following items:

- an electrode stack removal tool
- a small vial of aluminum oxide powder
- 40 cotton swabs
- 10 finger cots

Perform the following procedure to clean the PID lamp:

- Verify that the EAGLE 3 is off.
- Place the EAGLE 3 upside down on a flat surface or hold it upside down.
- Unscrew the three case screws until they disengage from the top case. They are captive screws so they will not fall off of the bottom case.

4. Turn the EAGLE 3 right side up and carefully lift the top case away from the bottom case. Be careful not to lift it so far that it pulls on the main PCB with the cable that connects the top case to the main PCB.
5. Lay the top case down next to the bottom case to allow access to the flow system.
6. Locate the PID sensor retainer. Figure 23 on page 191 shows a PID sensor in a typical location.
7. Unscrew the 2 screws that hold the sensor retainer to the flow block.

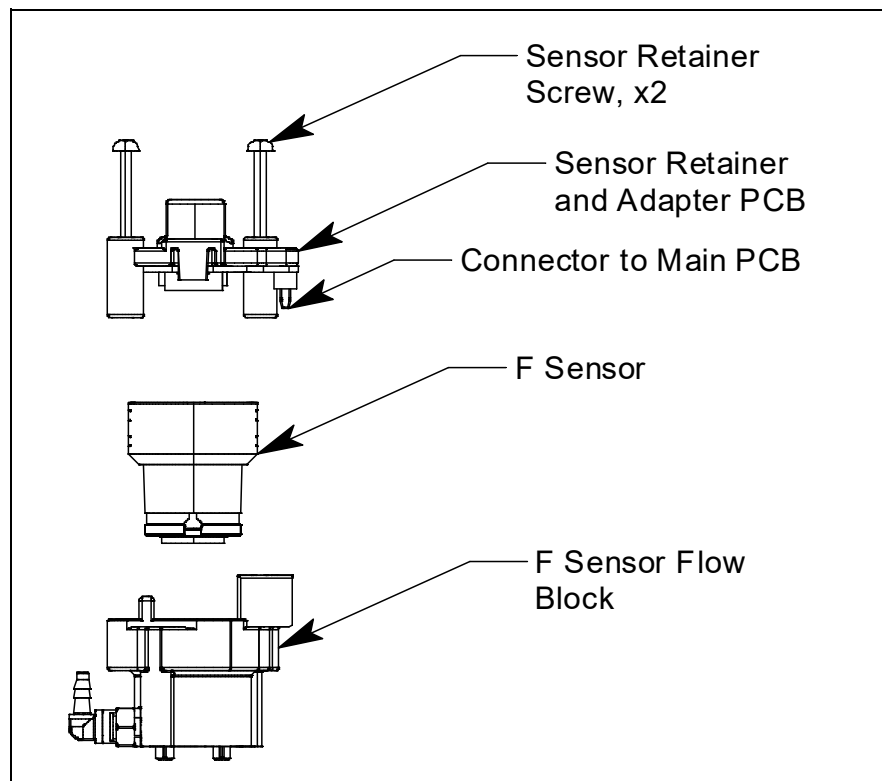

Figure 25: Removing a Sensor

8. Gently pull the sensor retainer away from the flow block. The sensor should come out with the sensor retainer.
9. Unplug the PID sensor from the F sensor base.
10. Place the PID sensor face down on a flat clean working surface, with the three pins facing up.

NOTE: Do not touch the lamp window with your fingers as this may contaminate the window with finger oil. At this point it is recommended that the finger cots be used on the fingers handling the lamp. Finger cots are included with the lamp cleaning kit.

11. Hold the PID sensor steady on the working surface with one hand and using the other hand, locate the tabs on the electrode stack removal tool and insert them into the slots on the side of the PID sensor near the face.

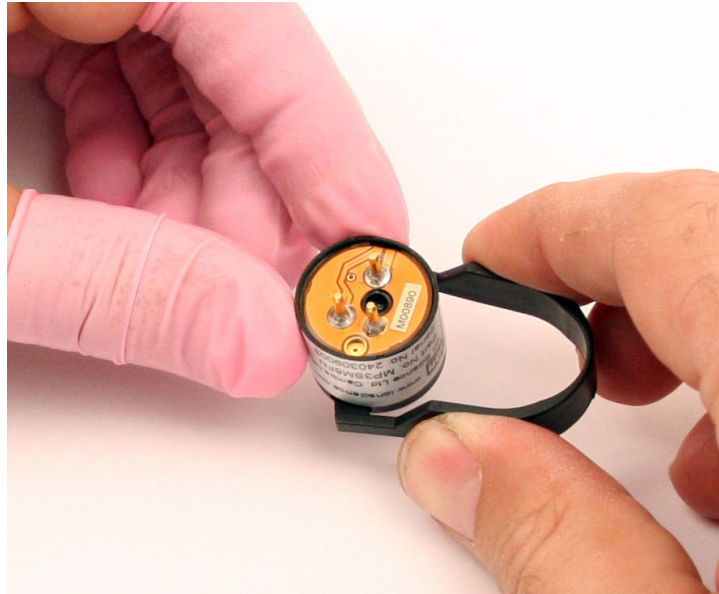

Figure 26: Using Removal Tool

12. Squeeze the removal tool to push the tabs into the sensor slots until the electrode stack and lamp are released.
13. Carefully lift the PID sensor body away from the electrode stack and lamp. Take care not to touch the lamp window, the flat end of the lamp, with your fingers. If the lamp remains lodged in the sensor body, carefully remove it with tweezers.

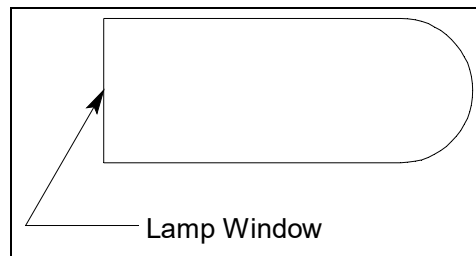

Figure 27: Lamp Window Location

14. If the spring in the lamp cavity comes out, place it back into the lamp cavity.
15. Hold the lamp in one hand being careful not to touch the lamp window with your fingers.
16. With the other hand collect a small amount of aluminum oxide powder on a cotton swab.

17. Use this cotton swab to polish the PID lamp window. Use a circular motion, applying light pressure to clean the lamp window. Do not touch the lamp window with your fingers.

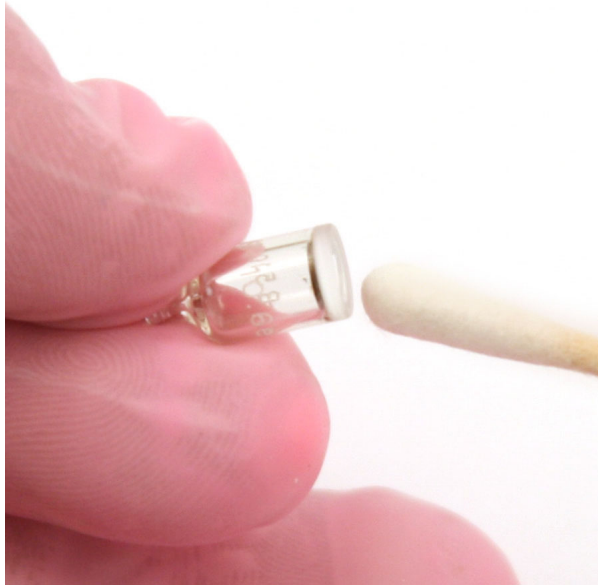

Figure 28: Polishing the Electrode Lamp Window

18. Continue polishing until you can hear a squeaking sound made by the cotton swab moving over the window surface. This usually occurs after about 15 seconds of polishing.
19. Remove the residual powder from the lamp window with a clean cotton swab. Take care not to touch the tip of the cotton swab that is used to clean the lamp as this may contaminate it with finger oil.
20. Ensure the lamp is completely dry and any visible signs of contamination are removed before reinstalling.
21. Hold the electrode stack between the thumb and forefinger of one hand and place the window end of the lamp inside the O-ring seal in the electrode stack with the other hand as shown below.

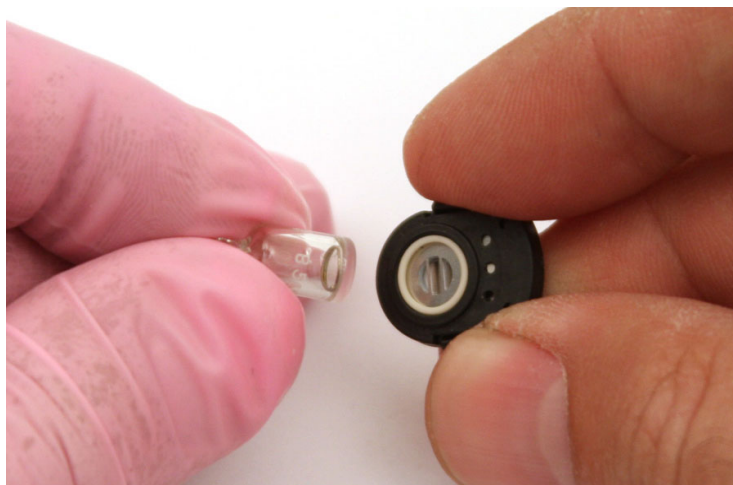

Figure 29: Reinstalling the Electrode Lamp

22. Twisting the lamp slightly during insertion will help to ensure the lamp window is snug against the stack's front electrode. The lamp should be supported by the O-ring.
23. Continuing to hold the electrode stack between your forefinger and thumb, carefully insert the lamp into the lamp cavity in the sensor ensuring that the lamp remains in position.
24. Press in the electrode stack firmly to ensure that the stack wing clips are engaged and the faces of the stack and sensor body are flush.
25. Carefully line up the PID sensor's 3 pins with the sockets in the F sensor base and push the PID sensor into the F sensor base.
26. If the F sensor base came off of the adapter PCB, push the F sensor base onto the adapter PCB, making sure that the connectors on the adapter PCB and F sensor base are lined up.
27. Insert the sensor and retainer into the PID flow chamber, ensuring the retainer is aligned with the two standoffs and the sensor adapter PCB is aligned with the main PCB connector.
28. Screw the two sensor retainer screws by alternately tightening them to push the sensor into its chamber and the sensor adapter PCB into the main PCB connector evenly.
29. Confirm that the main PCB is seated in its slots and that its bottom edge is resting on the bottom of the bottom case. If the main PCB is not seated properly, it may be damaged when the top case is re-installed.
30. Ensure that all internal tubing is connected without any pinched lines.
31. Make sure that the top case gasket is fully seated in its groove and carefully put the top case back on the bottom case. If you have any difficulty mating the top and bottom cases, inspect the placement of the main PCB and the placement of the top case gasket.
32. Turn the EAGLE 3 upside down and tighten the three case screws to secure the top case to the bottom case. Screws should be tightened to a torque of at least 30 N/cm.
33. Calibrate the PID channel as described on page 196.

Replacing the PID Sensor's Lamp

If cleaning the PID lamp does not resolve any calibration problems you may be having, the lamp may need to be replaced.

NOTE: Do not touch the new lamp window (the flat end) with your fingers as this may contaminate the window with finger oil.

1. Verify that the EAGLE 3 is off.
2. Place the EAGLE 3 upside down on a flat surface or hold it upside down.
3. Unscrew the three case screws until they disengage from the top case. They are captive screws so they will not fall off of the bottom case.

4. Turn the EAGLE 3 right side up and carefully lift the top case away from the bottom case. Be careful not to lift it so far that it pulls on the main PCB with the cable that connects the top case to the main PCB.
5. Lay the top case down next to the bottom case to allow access to the flow system.
6. Locate the PID sensor retainer. Figure 23 on page 191 shows a PID sensor in a typical location.
7. Unscrew the 2 screws that hold the sensor retainer to the flow block.

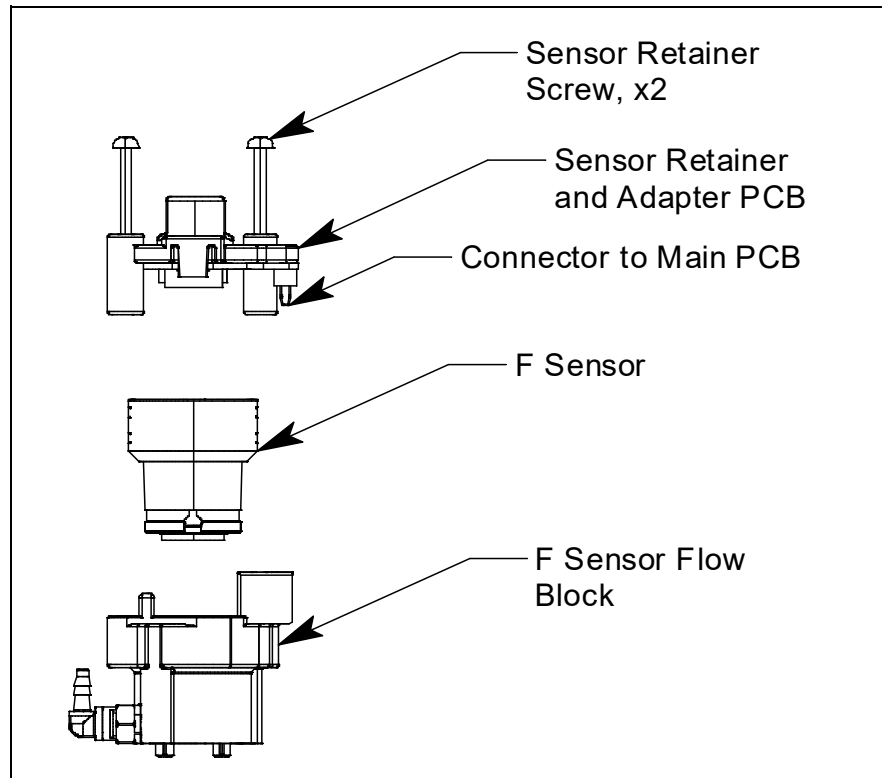

Figure 30: Removing a Sensor

8. Gently pull the sensor retainer away from the flow block. The sensor should come out with the sensor retainer.
9. Unplug the PID sensor from the F sensor base.
10. Place the PID sensor face down on a flat clean working surface, with the three pins facing up.

11. Hold the PID sensor steady on the working surface with one hand and using the other hand, locate the tabs on the electrode stack removal tool and insert them into the slots on the side of the PID sensor near the face.

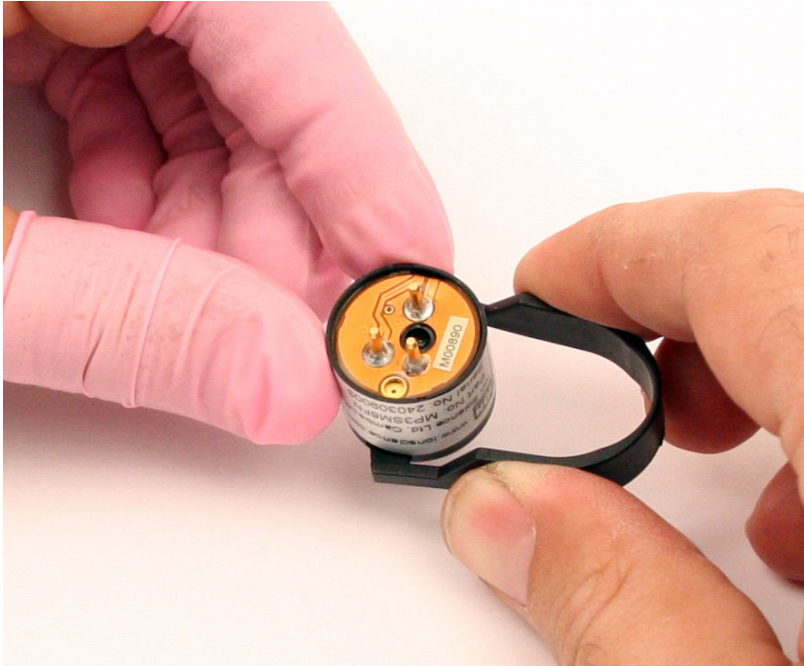

Figure 31: Using Removal Tool

12. Squeeze the removal tool to push the tabs into the sensor slots until the electrode stack and lamp are released.
13. Carefully lift the PID sensor body away from the electrode stack and lamp. If the lamp remains lodged in the sensor body, carefully remove it with tweezers.
14. If the spring in the lamp cavity comes out, place it back into the lamp cavity.
15. Discard the old PID lamp.

NOTE: At this point it is recommended that the finger cots be used on the fingers handling the lamp. Finger cots are included with the lamp cleaning kit.

16. Hold the electrode stack between the thumb and forefinger of one hand and place the window end of the new lamp inside the O-ring seal in the electrode stack with the other hand as shown below. Take care not to touch the lamp window.

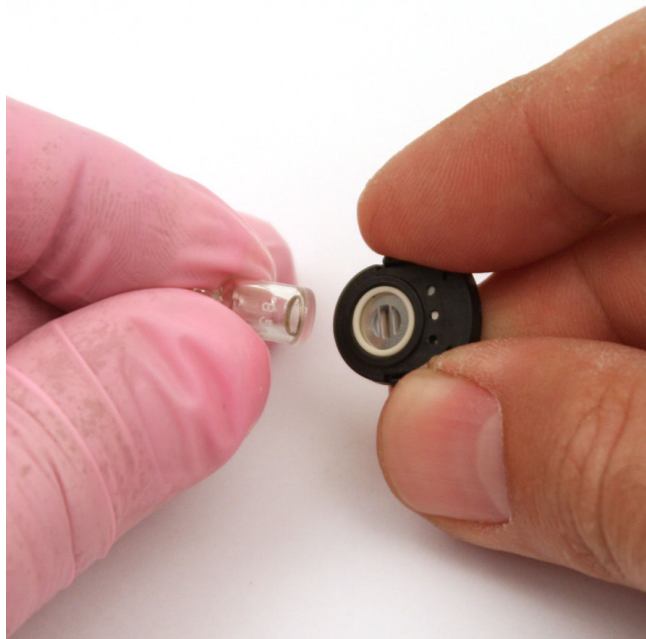

Figure 32: Reinstalling the Electrode Lamp

17. Twisting the lamp slightly during insertion will help to ensure the lamp window is snug against the stack's front electrode. The lamp should be supported by the O-ring.
18. Continuing to hold the electrode stack between your forefinger and thumb, carefully insert the lamp into the lamp cavity in the sensor ensuring that the lamp remains in position.
19. Press in the electrode stack firmly to ensure that the stack wing clips are engaged and the faces of the stack and sensor body are flush.
20. Carefully line up the PID sensor's 3 pins with the sockets in the F sensor base and push the PID sensor into the F sensor base.
21. If the F sensor base came off of the adapter PCB, push the F sensor base onto the adapter PCB, making sure that the connectors on the adapter PCB and F sensor base are lined up.
22. Insert the sensor and retainer into the PID flow chamber, ensuring the retainer is aligned with the two standoffs and the sensor adapter PCB is aligned with the main PCB connector.
23. Screw the two sensor retainer screws by alternately tightening them to push the sensor into its chamber and the sensor adapter PCB into the main PCB connector evenly.
24. Confirm that the main PCB is seated in its slots and that its bottom edge is resting on the bottom of the bottom case. If the main PCB is not seated properly, it may be damaged when the top case is re-installed.
25. Ensure that all internal tubing is connected without any pinched lines.

26. Make sure that the top case gasket is fully seated in its groove and carefully put the top case back on the bottom case. If you have any difficulty mating the top and bottom cases, inspect the placement of the main PCB and the placement of the top case gasket.
27. Turn the EAGLE 3 upside down and tighten the three case screws to secure the top case to the bottom case. Screws should be tightened to a torque of at least 30 N/cm.
28. Calibrate the PID channel as described on page 196.

Replacing the Electrode Stack

The electrode stack can last for the life of the PID sensor if the EAGLE 3 is used in a very clean, controlled environment. When used in a heavily contaminated or dirty environment, the electrode stack may only last a month. A contaminated electrode stack will cause a drop in sensitivity which can cause problems calibrating the PID channel. The electrode stack should be replaced if the PID sensor shows signs of contamination even after cleaning or replacing the lamp.

NOTE: Do not touch the new lamp window (the flat end) with your fingers as this may contaminate the window with finger oil.

1. Verify that the EAGLE 3 is off.
2. Place the EAGLE 3 upside down on a flat surface or hold it upside down.
3. Unscrew the three case screws until they disengage from the top case. They are captive screws so they will not fall off of the bottom case.
4. Turn the EAGLE 3 right side up and carefully lift the top case away from the bottom case. Be careful not to lift it so far that it pulls on the main PCB with the cable that connects the top case to the main PCB.
5. Lay the top case down next to the bottom case to allow access to the flow system.
6. Locate the PID sensor retainer. Figure 23 on page 191 shows a PID sensor in a typical location.

7. Unscrew the 2 screws that hold the sensor retainer to the flow block.

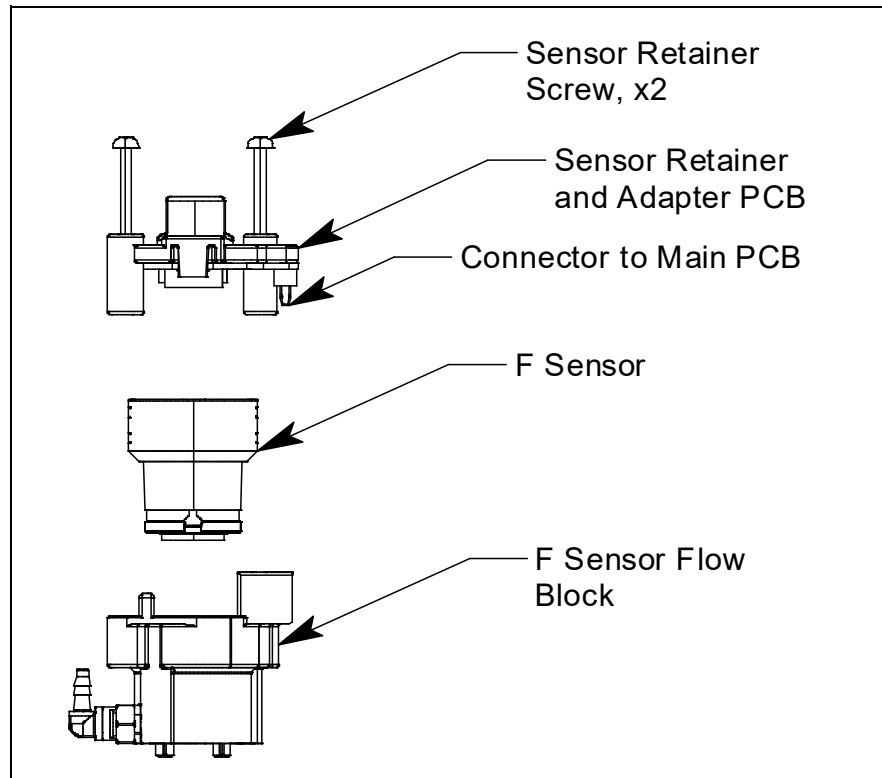

Figure 33: Removing a Sensor

8. Gently pull the sensor retainer away from the flow block. The sensor should come out with the sensor retainer.
9. Unplug the PID sensor from the F sensor base.
10. Place the PID sensor face down on a flat clean working surface, with the three pins facing up.

NOTE: At this point it is recommended that the finger cots be used on the fingers handling the lamp. Finger cots are included with the lamp cleaning kit.

11. Hold the PID sensor steady on the working surface with one hand and using the other hand, locate the tabs on the electrode stack removal tool and insert them into the slots on the side of the PID sensor near the face.

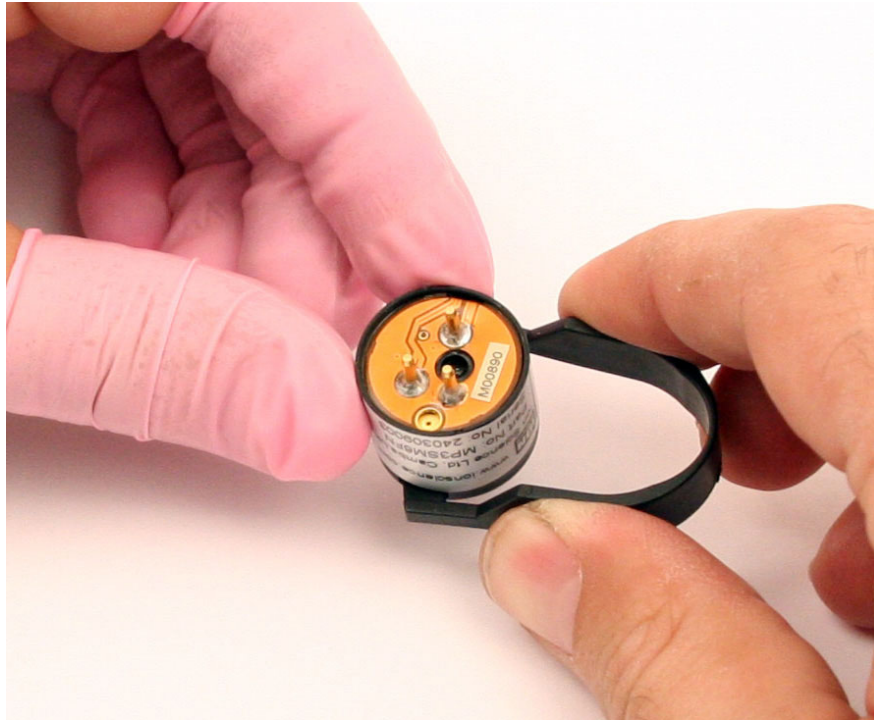

Figure 34: Using Removal Tool

12. Squeeze the removal tool to push the tabs into the sensor slots until the electrode stack and lamp are released.
13. Carefully lift the PID sensor body away from the electrode stack and lamp. If the lamp remains lodged in the sensor body, carefully remove it with tweezers.
14. If the spring in the lamp cavity comes out, place it back into the lamp cavity.
15. Discard the old electrode stack.
16. Hold the new electrode stack between the thumb and forefinger of one hand and place the window end of the lamp inside the O-ring seal in the new electrode stack with the other hand as shown below. Take care not to touch the lamp window.

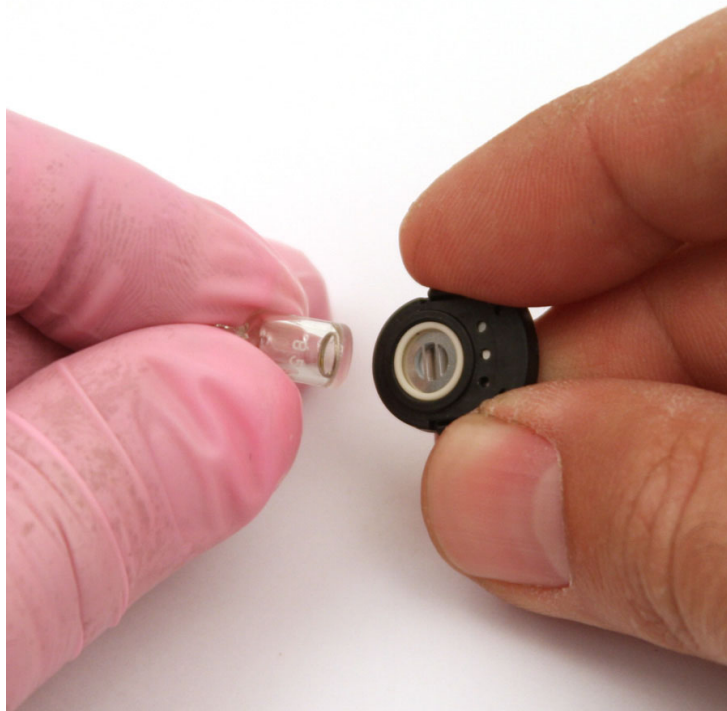

Figure 35: Reinstalling Electrode Lamp

17. Twisting the lamp slightly during insertion will help to ensure the lamp window is snug against the stack's front electrode. The lamp should be supported by the O-ring.
18. Continuing to hold the electrode stack between your forefinger and thumb, carefully insert the lamp into the lamp cavity in the sensor ensuring that the lamp remains in position.
19. Press in the electrode stack firmly to ensure that the stack wing clips are engaged and the faces of the stack and sensor body are flush.
20. Carefully line up the PID sensor's 3 pins with the sockets in the F sensor base and push the PID sensor into the F sensor base.
21. If the F sensor base came off of the adapter PCB, push the F sensor base onto the adapter PCB, making sure that the connectors on the adapter PCB and F sensor base are lined up.
22. Insert the sensor and retainer into the PID flow chamber, ensuring the retainer is aligned with the two standoffs and the sensor adapter PCB is aligned with the main PCB connector.
23. Screw the two sensor retainer screws by alternately tightening them to push the sensor into its chamber and the sensor adapter PCB into the main PCB connector evenly.
24. Confirm that the main PCB is seated in its slots and that its bottom edge is resting on the bottom of the bottom case. If the main PCB is not seated properly, it may be damaged when the top case is re-installed.
25. Ensure that all internal tubing is connected without any pinched lines.

26. Make sure that the top case gasket is fully seated in its groove and carefully put the top case back on the bottom case. If you have any difficulty mating the top and bottom cases, inspect the placement of the main PCB and the placement of the top case gasket.
27. Turn the EAGLE 3 upside down and tighten the three case screws to secure the top case to the bottom case. Screws should be tightened to a torque of at least 30 N/cm.
28. Calibrate the PID channel as described on page 196.

Replacing the PID Sensor

1. Verify that the EAGLE 3 is off.
2. Place the EAGLE 3 upside down on a flat surface or hold it upside down.
3. Unscrew the three case screws until they disengage from the top case. They are captive screws so they will not fall off of the bottom case.
4. Turn the EAGLE 3 right side up and carefully lift the top case away from the bottom case. Be careful not to lift it so far that it pulls on the main PCB with the cable that connects the top case to the main PCB.
5. Lay the top case down next to the bottom case to allow access to the flow system.
6. Locate the PID sensor and retainer. Figure 23 on page 191 shows a PID sensor in a typical location.

7. Unscrew and remove the two screws that hold down the sensor retainer.

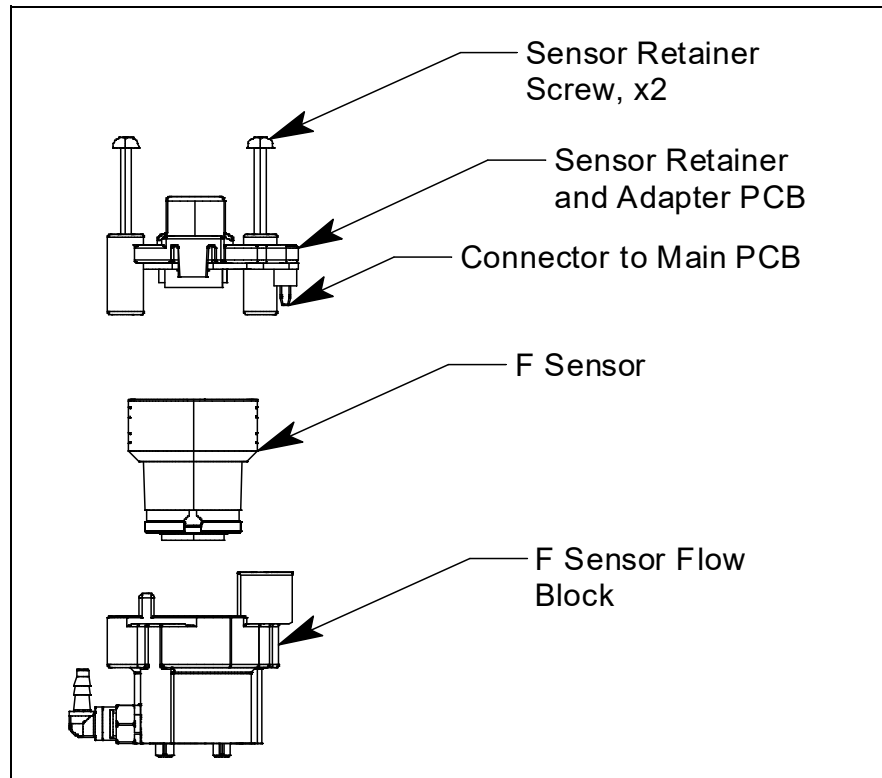

Figure 36: Replacing a Sensor

8. Grasp the retainer and sensor firmly and hold down the side of the case with the main PCB, then pull the sensor and retainer out of the flow chamber. Unplug the old PID sensor from the F sensor base that connects to the sensor adapter PCB.
9. Plug the new PID sensor into the F sensor base.
10. Insert the sensor and retainer into the PID flow chamber, ensuring the retainer is aligned with the two standoffs and the sensor adapter PCB is aligned with the main PCB connector.
11. Screw the two sensor retainer screws by alternately tightening them to push the sensor into its chamber and the sensor adapter PCB into the main PCB connector evenly.
12. Confirm that the main PCB is seated in its slots and that its bottom edge is resting on the bottom of the bottom case. If the main PCB is not seated properly, it may be damaged when the top case is re-installed.
13. Ensure that all internal tubing is connected without any pinched lines.
14. Make sure that the top case gasket is fully seated in its groove and carefully put the top case back on the bottom case. If you have any difficulty mating the top and bottom cases, inspect the placement of the main PCB and the placement of the top case gasket.
15. Turn the EAGLE 3 upside down and tighten the three case screws to secure the top case to the bottom case. Screws should be tightened to a torque of at least 30 N/cm.

16. Calibrate the PID channel as described on page 196.

PID EAGLE 3 Parts List

Part Number	Description
33-0560RK	Electrode stack, 0 - 40 ppm, 2 pack
33-0562	Electrode stack, 0 - 4,000 ppm, HPPM type
33-6092	VOC zero filter, for zeroing low range PID sensors
51-1503	Replacement lamp, 10.6 eV low range and 10.6 eV high range
61-0302	Replacement PID sensor, 0 - 40 ppm VOC (does not include F sensor base)
61-0303	Replacement PID sensor, 0 - 4,000 ppm VOC (does not include F sensor base)
80-0605RK	Teflon-lined sample hose, 5 feet
80-0610RK	Teflon-lined sample hose, 10 feet
80-0615RK	Teflon-lined sample hose, 15 feet
80-0620RK	Teflon-lined sample hose, 20 feet
81-0103RK-01	Calibration cylinder, isobutylene, 100 ppm in air, 34 liter steel
81-0103RK-03	Calibration cylinder, isobutylene, 100 ppm in air, 103 liter
81-0103RK-04	Calibration cylinder, isobutylene, 100 ppm in air, 34 liter aluminum
81-0104RK-01	Calibration cylinder, isobutylene, 10 ppm in air, 34 liter steel
81-0104RK-03	Calibration cylinder, isobutylene, 10 ppm in air, 103 liter
81-0104RK-04	Calibration cylinder, isobutylene, 10 ppm in air, 34 liter aluminum
81-0143RK-02	Calibration cylinder, 5-gas (Proprietary blend of IBL, CH ₄ , O ₂ , H ₂ S, CO), 58-liter aluminum
81-0143RK-04	Calibration cylinder, 5-gas (Proprietary blend of IBL, CH ₄ , O ₂ , H ₂ S, CO), 34-liter aluminum
81-1054RK	Regulator, demand-flow type (for 58- and 103-liter aluminum or steel, and 34-liter aluminum cylinder)
81-1055RK	Regulator, demand-flow type (for 17- and 34-liter steel cylinder)
82-0003RK	Electrode stack removal tool
82-0300RK	Lamp cleaning kit with electrode stack removal tool
PIF-BASE-TEN6-L	F-sensor base for low range PID sensor
PIF-BASE-TEN6-H	F-sensor base for high range PID sensor

Appendix D: ESF Toxic Sensors

Overview

The ESF sensors are used to monitor levels of a variety of toxic gases. This appendix describes the EAGLE 3's ESF sensors and includes instructions to use an EAGLE 3 that has one or more ESF sensors installed. It also includes instructions to replace an ESF sensor.

NOTE: Instruments that have ESF toxic sensors installed need a Teflon-lined hose for proper operation.

For the HCl, HBr, HF, F₂, O₃, and ClF₃ sensors, dedicated nipples must be used instead of the standard probe due to absorption issues.

Table 22: ESF Detection Specifications

Target Gas	Detection Range	Increment	Alarm 1 Factory Setting	Alarm 2 Factory Setting	STEL (ppm)	TWA (ppm)
Ammonia (NH ₃)	0 - 75.0 ppm	0.5 ppm	25.0 ppm	50.0 ppm	35 ppm	25 ppm
Chlorine (Cl ₂)	0 - 3.00 ppm	0.02 ppm	1.00 ppm	2.00 ppm	OFF	OFF
Chlorine Trifluoride (ClF ₃)	0 - 0.300 ppm	0.002 ppm	0.100 ppm	0.200 ppm	OFF	OFF
Disilane (Si ₂ H ₆)	0 - 15.0 ppm	0.1 ppm	5.0 ppm	10.0 ppm	OFF	OFF
Fluorine (F ₂)	0 - 3.00 ppm	0.02 ppm	1.00 ppm	2.00 ppm	OFF	OFF
Germane (GeH ₄)	0 - 0.800 ppm	0.005 ppm	0.200 ppm	0.400 ppm	OFF	0.200 ppm
Hydrogen Bromide (HBr)	0 - 6.00 ppm	0.05 ppm	2.00 ppm	4.00 ppm	OFF	OFF
Hydrogen Chloride (HCl)	0 - 6.00 ppm	0.05 ppm	2.00 ppm	4.00 ppm	OFF	OFF
Hydrogen Cyanide (HCN)	0 - 15.0 ppm	0.1 ppm	5.0 ppm	10.0 ppm	4.7 ppm	OFF
Hydrogen Fluoride (HF)	0 - 1.5 ppm	0.01 ppm	0.50 ppm	1.00 ppm	OFF	0.5
Hydrogen Sulfide (H ₂ S)*	0 - 1000 ppm**	1 ppm	1000 ppm	1000 ppm	OFF	OFF
Nitrogen Oxide (NO)	0 - 100 ppm	1 ppm	25 ppm	50 ppm	OFF	25 ppm
Nitrogen Dioxide (NO ₂)	0 - 15.0 ppm	0.1 ppm	5.0 ppm	10.0 ppm	OFF	OFF
Ozone (O ₃)	0 - 0.600 ppm	0.05 ppm	0.100 ppm	0.200 ppm	OFF	0.100 ppm
Phosphine (PH ₃)	0 - 1.00 ppm	0.01 ppm	0.30 ppm	0.60 ppm	OFF	OFF
Silane (SiH ₄)	0 - 15.0 ppm	0.1 ppm	5.0 ppm	10.0 ppm	OFF	5.0 ppm
Sulfur Dioxide (SO ₂)	0 - 6.00 ppm	0.05 ppm	2.00 ppm	4.00 ppm	OFF	OFF
	0 - 100.0 ppm	0.1 ppm	2.0 ppm	5.0 ppm	5.0 ppm	2.0 ppm

Table 22: ESF Detection Specifications

* Alarm points 1 and 2 are effectively disabled for this range.

** No dilution required to get this range.

Table 23: General Sensor Specifications (ESF Series)

Detection Principle	Electrochemical	
Zero Suppression	All sensors <i>not</i> listed below	6% of full scale
	H ₂ S (high-range)	2% of full scale
	Sulfur Dioxide (SO ₂)	<ul style="list-style-type: none"> • +/- 0.35 ppm for 0 - 6 ppm range • +/- 0.4% of full scale for 0 - 100 ppm range
Accuracy	All sensors <i>not</i> listed below	+/- 30%
	Hydrogen Sulfide (H ₂ S)	+/- 20%
	Sulfur Dioxide (SO ₂)	<ul style="list-style-type: none"> • +/- 0.3 ppm for 0 - 6 ppm range • +/- 5 ppm for 0 - 100 ppm range
Response Time	All sensors <i>not</i> listed below	≤ 60 seconds (T62.5)
	Hydrogen Sulfide (H ₂ S), high-range	≤ 30 seconds (T90)
	<ul style="list-style-type: none"> • Disilane (Si₂H₆) • Germane (GeH₄) • Hydrogen Cyanide (HCN) • Nitrogen Dioxide (NO₂) • Nitrogen Oxide (NO) • Phosphine (PH₃) • Silane (SiH₄) • Sulfur Dioxide (SO₂) 	≤ 30 seconds (T62.5)
Operating Temperature(s)	All sensors <i>not</i> listed below	-20°C to 50°C
	<ul style="list-style-type: none"> • Hydrogen Bromide (HBr) • Hydrogen Chloride (HCl) • Fluorine (F₂) • Hydrogen Fluoride (HF) • Chlorine Trifluoride (ClF₃) 	0°C to 40°C
	Chlorine (Cl ₂)	0°C to 50°C
	Ozone (O ₃)	10°C to 40°C

Description

The ESF is a smart sensor that stores sensor parameters including the target gas, detection range, alarm points, and calibration settings in its memory. Please be sure to perform gas adjustment after installing the product. For all ESF compatible models, gas adjustment is required after installation.

NOTE: Due to the way they operate, electrochemical type sensors may exhibit positive or negative sensitivity to gases other than the detection target gas. In environments where interference gases are present, the reading may differ from the actual concentration of the detection target gas present. Note that false alarms or **M OVER** alarms may be triggered, especially at high concentrations.

In addition, you can change an existing ESF channel from one type of ESF sensor to another and the EAGLE 3 will automatically load all the sensor parameters and configure the ESF channel for the new sensor without the need to enter **Configure Channels** or **Configure Gases** in Setup Mode. See page 216 for instructions to replace or change an ESF sensor.

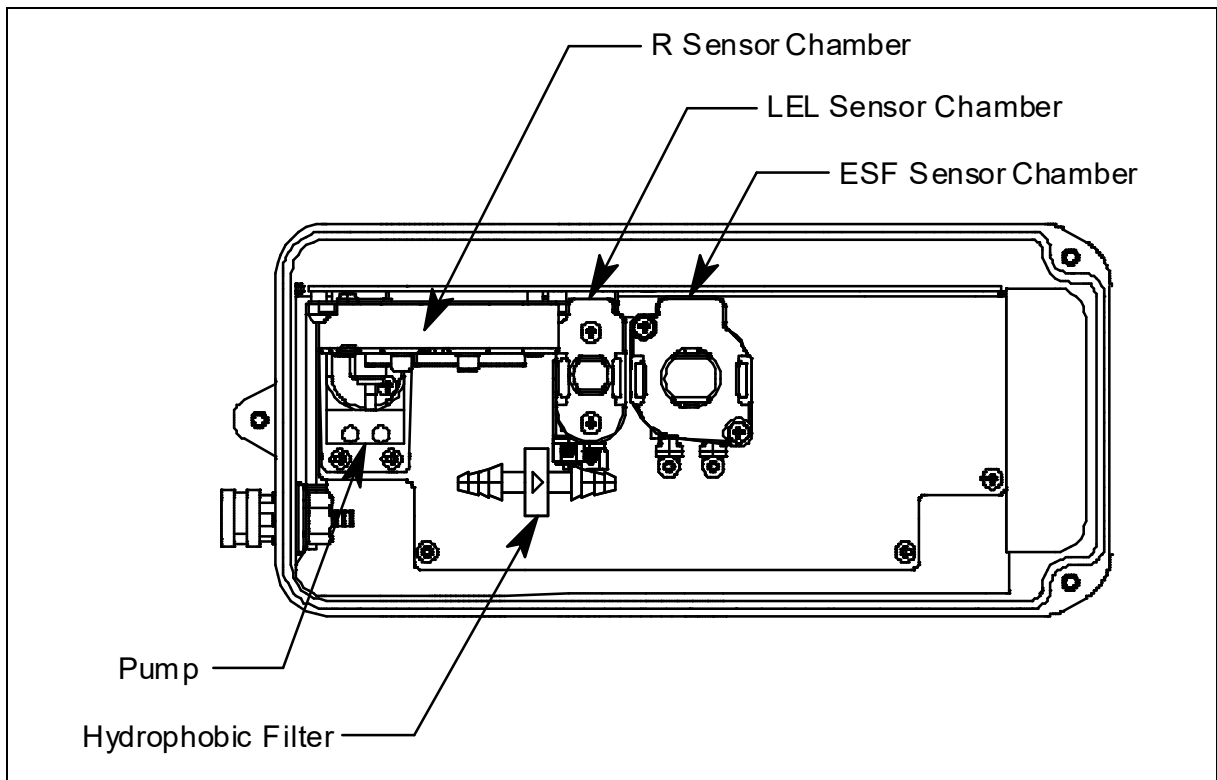

Figure 37: Typical ESF Sensor Location

The ESF sensor is installed in a single sensor flow chamber which is located next to the LEL sensor chamber. This area can accommodate up to three single sensor flow chambers. Although the EAGLE 3 can support up to three ESF sensors, many combinations are impractical for various reasons including sensor cross sensitivity to other gases. Consult with RKI Instruments, Inc. for practical combinations. Figure 37 above illustrates a typical ESF sensor location. The ESF flow chamber may also be installed in one of the other two sensor chamber locations depending on the particular version of the EAGLE 3. Some ESF instrument configurations do not include the LEL sensor chamber.

ESF Sensor

The ESF sensor is a cylindrical sensor with a diffusion opening on the front and a connector on the back. The connector mates to the an adapter PCB that's installed on the bottom of the sensor retainer to keep the sensor in place. This sensor adapter slots into a connector on the main PCB when the sensor is installed into its flow chamber using the two retaining screws.

Start Up and Normal Operation

For instructions to warmup and use an EAGLE 3 that includes an ESF sensor, reference “Start Up” on page 30, “Normal Mode Operation” on page 43, and “Alarms” on page 52. Follow these instructions keeping the following special considerations in mind:

- Several of the gases that can be monitored with an ESF are absorbed in the longer EAGLE 3 sample hoses. Do not use sample hoses that are longer than the standard 5 foot hose without consulting RKI Instruments, Inc.
- If your EAGLE 3 has more than one ESF sensor installed, it is possible that both sensors will respond to some of the same gases at varying levels. Make sure you understand any issues like this that may exist in your particular instrument.

ESF Calibration

See “Chapter 5: Calibration Mode” on page 79 for calibration instructions. A 5-gas mix can be used to calibrate an instrument that includes the standard 4 gases and an SO₂ sensor. All other ESF sensors will need their own cylinder of calibration gas.

WARNING: RKI Instruments, Inc. recommends that you dedicate a regulator for use with chlorine (Cl₂) gas and that you do not use that dedicated regulator for any other gases, particularly hydrogen sulfide (H₂S).

Maintenance

CAUTION: After the EAGLE 3 case is opened, check that all pump tubing is securely connected and there are no kinks in the lines before securing the top case.

Replacing the ESF Sensor or Changing Sensor Type

1. Verify that the EAGLE 3 is off.
2. Place the EAGLE 3 upside down on a flat surface or hold it upside down.
3. Unscrew the three case screws until they disengage from the top case. They are captive screws so they will not fall off of the bottom case.
4. Turn the EAGLE 3 right side up and carefully lift the top case away from the bottom case. Be careful not to lift it so far that it pulls on the main PCB with the cable that connects the top case to the main PCB.
5. Lay the top case down next to the bottom case to allow access to the flow system.
6. Locate the ESF sensor and retainer. Figure 37 on page 214 shows an ESF sensor in a typical location.
7. Unscrew and remove the two screws that hold down the sensor retainer.

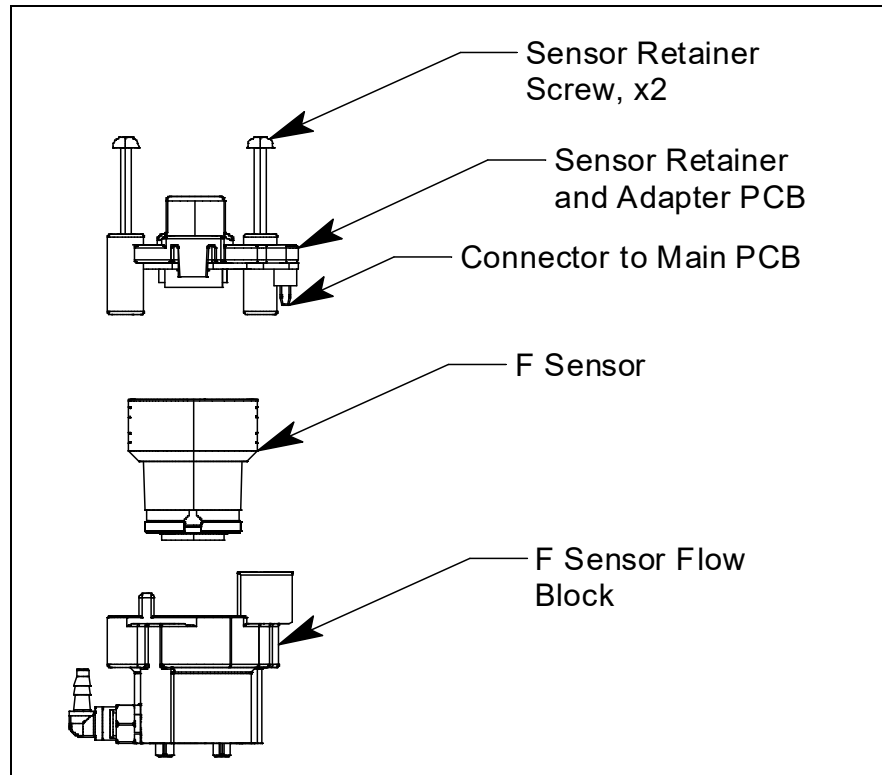

Figure 38: Replacing a Sensor

8. Grasp the retainer and sensor firmly and hold down the side of the case with the main PCB, then pull the sensor and retainer out of the flow chamber. Unplug the old ESF sensor from the sensor adapter PCB on the bottom of the retainer.
9. Plug the new ESF sensor into the sensor adapter PCB.
10. Insert the sensor and retainer into the ESF flow chamber, ensuring the retainer is aligned with the two standoffs and the sensor adapter PCB is aligned with the main PCB connector.
11. Screw the two sensor retainer screws by alternately tightening them to push the sensor into its chamber and the sensor adapter PCB into the main PCB connector evenly.
12. Confirm that the main PCB is seated in its slots and that its bottom edge is resting on the bottom of the bottom case. If the main PCB is not seated properly, it may be damaged when the top case is re-installed.
13. Ensure that all internal tubing is connected without any pinched lines.
14. Make sure that the top case gasket is fully seated in its groove and carefully put the top case back on the bottom case. If you have any difficulty mating the top and bottom cases, inspect the placement of the main PCB and the placement of the top case gasket.
15. Turn the EAGLE 3 upside down and tighten the three case screws to secure the top case to the bottom case. Screws should be tightened to a torque of at least 30 N/cm.
16. Calibrate the ESF channel as described in “ESF Calibration” on page 215.

ESF EAGLE 3 Parts List

Part Number	Description
ESF-A24D-HCN	Hydrogen cyanide sensor, 0-15.0 ppm
ESF-A24D-PH3	Phosphine sensor, 0-1.00 ppm
ESF-A24D-SI2H6	Disilane sensor 0-15.0 ppm
ESF-A24D2-NO	Nitric oxide sensor, 0-100.0 ppm
ESF-A24D4-SO2	Sulfur dioxide sensor, 0-100.0 ppm
ESF-A24E2-HBR	Hydrogen bromide sensor 0-6.00 ppm
ESF-A24E2-HCL	Hydrogen chloride sensor, 0-6.00 ppm
ESF-A24R2-H2S1K	Hydrogen sulfide sensor, 0-1,000 ppm
ESF-AA20-NO2	Nitrogen dioxide sensor 0-15.0 ppm
ESF-B24A-CLF3	Chlorine trifluoride sensor 0-0.300 ppm
ESF-B242-NH3	Ammonia sensor, 0-75.0 ppm
ESF-B248-F2	Fluorine sensor 0-3.00 ppm
ESF-B248X-HF	Hydrogen fluoride sensor 0.4-1.5 ppm

Part Number	Description
ESF-B249-O3	Ozone sensor, 0-6.00 ppm
ESF-C92-CL2-02	Chlorine sensor, 0-2.00 ppm
81-0142RK-02	Calibration cylinder, 5-gas (SO ₂ , CH ₄ , O ₂ , H ₂ S, CO), 58-liter aluminum
81-0142RK-04	Calibration cylinder, 5-gas (SO ₂ , CH ₄ , O ₂ , H ₂ S, CO), 34-liter aluminum
81-0170RK-02	Calibration cylinder, 5 ppm SO ₂ in nitrogen, 58 liter
81-0170RK-04	Calibration cylinder, 5 ppm SO ₂ in nitrogen, 34 liter aluminum
81-0176RK-02	Calibration cylinder, 25 ppm NH ₃ in nitrogen, 58 liter
81-0176RK-04	Calibration cylinder, 25 ppm NH ₃ in nitrogen, 34 liter aluminum
81-0185RK-02	Calibration cylinder, 0.5 ppm PH ₃ in nitrogen, 58 liter
81-0192RK-02	Calibration cylinder, 2 ppm Cl ₂ in nitrogen, 58 liter
81-0192RK-04	Calibration cylinder, 2 ppm Cl ₂ in nitrogen, 34 liter aluminum
81-0195RK-02	Calibration cylinder, 5 ppm HCl in nitrogen, 58 liter
81-0196RK-02	Calibration cylinder, 10 ppm HCN in nitrogen, 58 liter
81-0196RK-04	Calibration cylinder, 10 ppm HCN in nitrogen, 34 liter aluminum
PIF-BASE-TEN6-L	F-sensor base for low range PID sensor
PIF-BASE-TEN6-H	F-sensor base for high range PID sensor

Appendix E: TC Sensors

Overview

The TC sensors are used to monitor high levels of combustible gas. This appendix describes the EAGLE 3's TC sensor and includes instructions to use an EAGLE 3 that has a TC sensor installed. It also includes instructions to calibrate and replace a TC sensor.

Table 24: TC Sensor Specifications

Target Gas	Detection Range	Reading Increment	Alarm 1 Factory Setting	Alarm 2 Factory Setting	STEL	TWA
Methane (CH ₄)	0 - 100.0% vol.	0.5% vol.	25% vol.	50% vol.	OFF	OFF
Hydrogen (H ₂)						
Isobutane (C ₄ H ₁₀)						
Propane (C ₃ H ₈)						

Description

The TC sensor is installed in a single sensor flow chamber which is located next to the LEL sensor chamber. This area can accommodate up to three single sensor flow chambers. Figure 39 below illustrates a typical TC sensor location. The TC flow chamber may also be installed in one of the other two sensor chamber locations depending on the particular version of the EAGLE 3. Some TC sensor instrument configurations do not include the LEL sensor chamber.

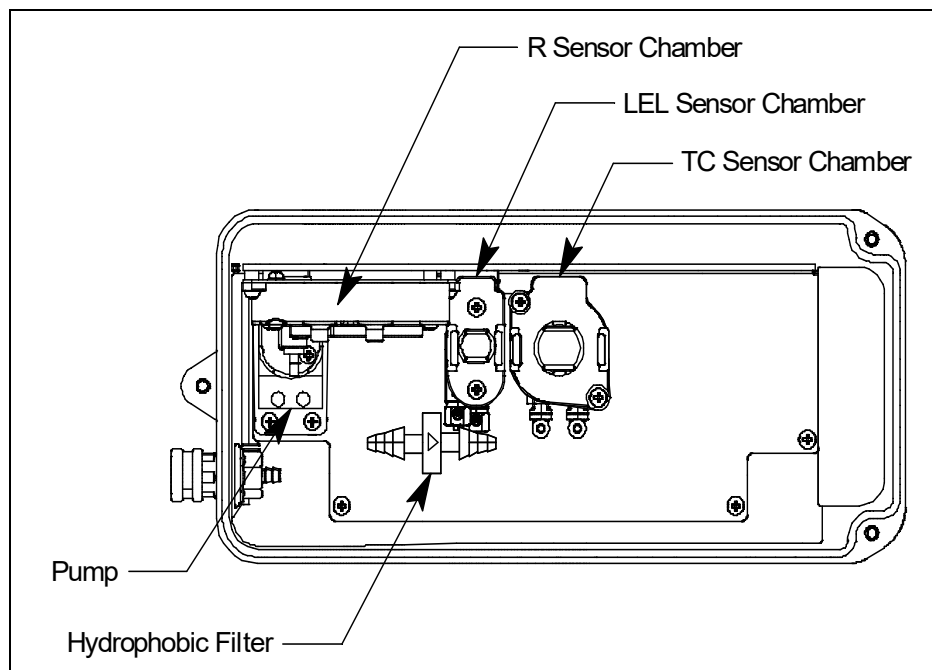

Figure 39: Typical TC Sensor Location

TC Sensor

The TC sensor is a cylindrical sensor with a diffusion opening on the front and 6 pins on the back. The pins plug into the F sensor base, which in turn plugs into the adapter PCB seated in the sensor retainer. The sensor retainer is secured to the flow block with 2 screws.

Start Up and Normal Operation

For instructions to warmup and use an EAGLE 3 that includes a TC sensor, reference “Start Up” on page 30, “Normal Mode Operation” on page 43, and “Alarms” on page 52. Follow these instructions keeping the following in mind:

- The TC sensor is used to monitor combustible gases above their LEL (lower explosive limit). When monitoring the target gas in % volume, be aware that you may be monitoring gas levels that are potentially explosive.

Catalytic (LEL) Sensor Screen

When either a TC sensor or an infrared combustible sensor is installed in an EAGLE 3 along with a catalytic combustible LEL sensor, the user has the option of turning off the catalytic combustible LEL sensor in Display Mode. If the unit is going to be used for sampling known high-levels of combustible gas or in areas with known catalytic sensor poisons such as silicone vapors, the catalytic combustible sensor should be turned off. Even though this sensor has its own protective shut off, exposure to high levels of combustible gas can still stress the catalytic LEL sensor. The catalytic LEL sensor can be enabled or disabled in the Catalytic (LEL) Sensor screen in Display Mode. The default setting is enabled. To change the setting, do the following:

NOTE: The Catalytic (LEL) Sensor setting is reset when the EAGLE 3 is turned off. When the EAGLE 3 is turned on, this setting is always ENABLED.

1. Use the **DISPLAY** button to enter Display Mode and scroll to the Catalytic (LEL) Sensor screen. Press **POWER** to enter the menu. The screen below indicates the warning that appears when a TC sensor and a catalytic LEL sensor are both installed. Since the TC sensor only reads in % volume, if the catalytic LEL sensor is disabled, there will be no alarms for the LEL range.

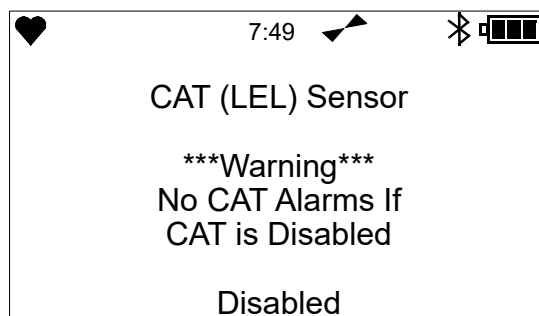

2. Use the **AIR** or **RANGE** button to toggle to the desired setting.
If set to **DISABLED**, the gas reading for the catalytic LEL channel will be replaced by dashes (---).
3. Press **POWER** to save the setting and return to the main menu.
4. Use the **DISPLAY** button to scroll through the rest of Display Mode and enter Normal Operation.

TC Calibration

In order to fully calibrate the TC sensor, both of the following must be performed:

1. A zero performed in “TE Base Calibration” menu as described on pg. 88
2. A span adjustment as described on pg. 89

Maintenance

The TC sensor does not include any user-serviceable parts. This section includes a procedure for replacing the TC sensor.

CAUTION: *After the EAGLE 3 case is opened, check that all pump tubing is securely connected and there are no kinks in the lines before securing the top case.*

Replacing the TC Sensor

1. Verify that the EAGLE 3 is off.
2. Place the EAGLE 3 upside down on a flat surface or hold it upside down.
3. Unscrew the three case screws until they disengage from the top case. They are captive screws so they will not fall off of the bottom case.
4. Turn the EAGLE 3 right side up and carefully lift the top case away from the bottom case. Be careful not to lift it so far that it pulls on the main PCB with the cable that connects the top case to the main PCB.
5. Lay the top case down next to the bottom case to allow access to the flow system.
6. Locate the TC sensor and retainer. Figure 39 on page 219 shows a TC sensor in a typical location.

7. Unscrew and remove the two screws that hold down the sensor retainer.

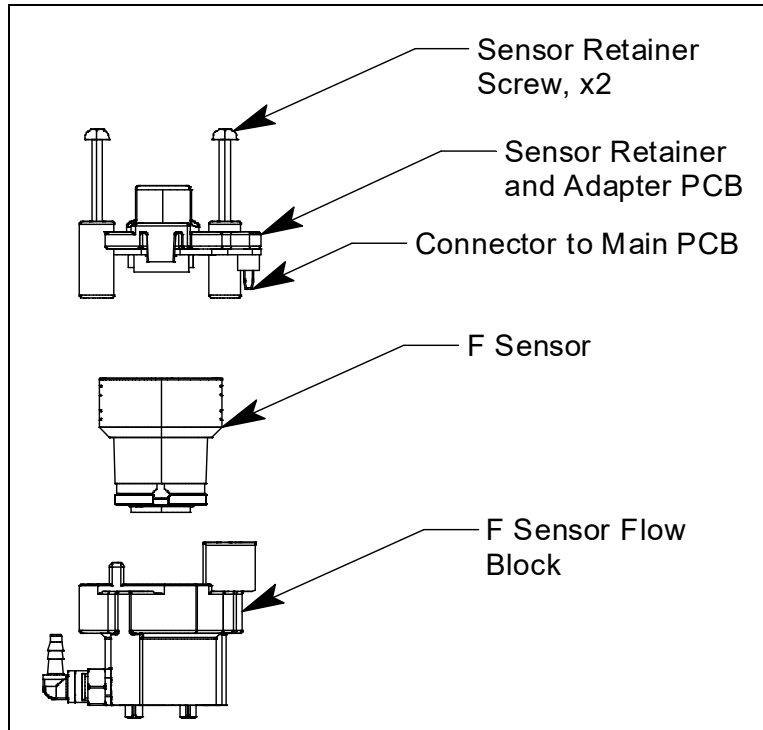

Figure 40: Replacing a Sensor

8. Grasp the retainer and sensor firmly and hold down the side of the case with the main PCB, then pull the sensor and retainer out of the flow chamber. Unplug the old TC sensor from the F sensor base that connects to the sensor adapter PCB.
9. Plug the new TC sensor into the F sensor base.
10. Insert the sensor and retainer into the TC flow chamber, ensuring the retainer is aligned with the two standoffs and the sensor adapter PCB is aligned with the main PCB connector.
11. Screw the two sensor retainer screws by alternately tightening them to push the sensor into its chamber and the sensor adapter PCB into the main PCB connector evenly.
12. Confirm that the main PCB is seated in its slots and that its bottom edge is resting on the bottom of the bottom case. If the main PCB is not seated properly, it may be damaged when the top case is reinstalled.
13. Ensure that all internal tubing is connected without any pinched lines.
14. Make sure that the top case gasket is fully seated in its groove and carefully put the top case back on the bottom case. If you have any difficulty mating the top and bottom cases, inspect the placement of the main PCB and the placement of the top case gasket.
15. Turn the EAGLE 3 upside down and tighten the three case screws to secure the top case to the bottom case. Screws should be tightened to a torque of at least 30 N/cm.
16. Calibrate the TC channel as described on page 221.

Configuring the TC Gas in Setup Mode

The TC channel can be configured for 3 different pre-defined gases and 1 user-defined gas in the CONFIGURE GASES menu item in Setup Mode. To change the gas configuration of the TC channel in Setup Mode, do the following:

WARNING: *Do not use the user defined gas configuration without consulting RKI Instruments, Inc.*

WARNING: *The EAGLE 3 is not in operation as a gas detector while in Setup Mode.*

1. Take the EAGLE 3 to a non-hazardous location and turn it off if it is on.
2. Press and hold **AIR** and **RANGE**, then press and hold **POWER**. When you hear a beep, release both buttons.
3. The screen that appears depends on the **Setup Password** setting in Setup Mode.
If **Setup Password** is set to **On** (factory setting), continue with Step 4.
If **Setup Password** is set to **Off**, continue with Step 6.
4. If **Setup Password** is set to **On**, a password screen appears. The factory-set password is **0000**, but it can be changed if desired.

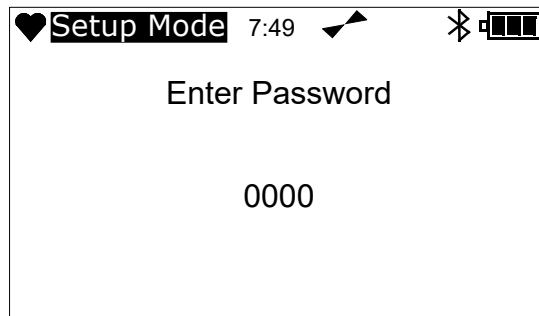

5. Press **AIR** to select each password number then press **POWER** to save it and move to the next number.
To return to a previous digit, press and release **DISPLAY**.
6. While in Setup Mode, press **AIR** or **RANGE** to scroll to **Configure Gases**.

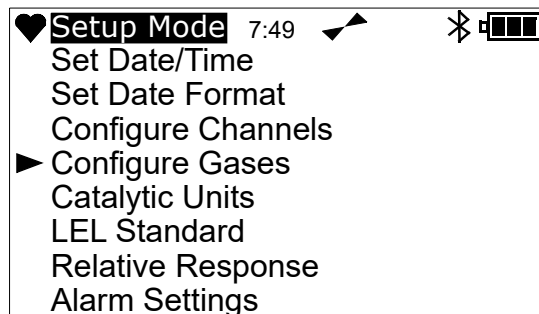

7. Press **POWER** to select the menu item. The **Configure Gases** screen appears with the catalytic channel's setting displayed, indicating that it can be adjusted.

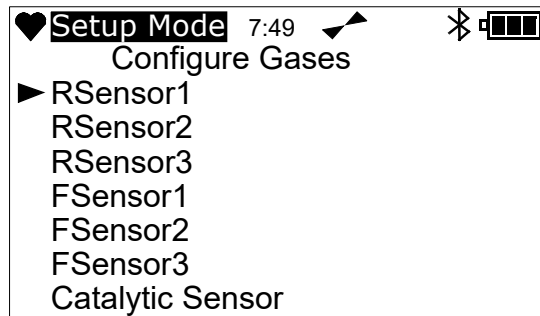
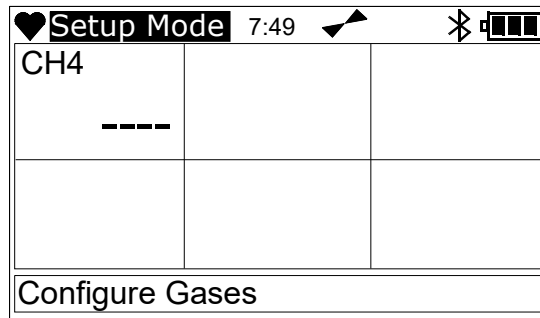

8. Press **AIR** or **RANGE** to scroll to the F sensor number for the TC sensor.
9. Press **POWER** to select the channel.
10. The gas list for the TC sensor appears.

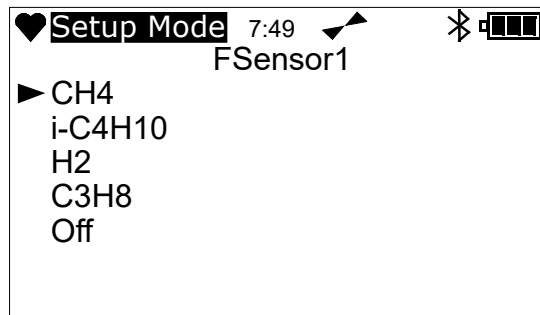

11. Use **AIR** or **RANGE** to scroll to the target gas you want to assign to the TC sensor.
12. Press **POWER** to select the gas and return to the **Configure Gases** screen.
13. Use **AIR** or **RANGE** to scroll to the Escape menu item.
14. Press **POWER**.
15. Use **RANGE** to scroll to **Normal Operation**.
16. Press **POWER**.

TC EAGLE 3 Parts List

Part Number	Description
81-0013RK-01	Calibration cylinder, 50% vol CH ₄ in N ₂ , 34 liter steel
81-0013RK-05	Calibration cylinder, 50% vol CH ₄ in N ₂ , 58 liter
81-0023RK-01	Calibration cylinder, H ₂ , 8% volume in nitrogen, 34 liter steel
81-0024RK-01	Calibration cylinder, H ₂ , 100% volume, 34 liter steel
81-0025RK-01	Calibration cylinder, 35% CO ₂ /50% CH ₄ , balance N ₂ , 34 liter steel, intended for landfill applications
TEF-7520P	TC sensor, all gases, plugin part only, does not include smart sensor base
TEF-BASE	Smart sensor base for TC sensors, all gases

Appendix F: Infrared Carbon Dioxide Sensors

Overview

The infrared CO₂ sensors are used to monitor levels of carbon dioxide. This appendix describes the EAGLE 3's infrared CO₂ sensors and includes instructions to use an EAGLE 3 that has one or more infrared CO₂ sensors installed. It also includes instructions to replace an infrared CO₂ sensor.

Table 25: Infrared CO₂ Sensor Specifications

Detection Range	Reading Increment	Alarm 1 Setpoint	Alarm 2 Setpoint	STEL Setpoint	TWA Setpoint
0 - 10,000 ppm	20 ppm	5000 ppm	5000 ppm	30000 ppm	5000 ppm
0 - 10.00% vol.	0.01% vol.	0.5% vol.	3.00% vol.	3.00% vol.	0.50% vol.
0 - 20.00% vol.	0.01% vol.	3.00% vol.	3.00% vol.	3.00% vol.	0.50% vol.
0 - 60.0% vol.	0.1% vol.	15.0% vol.	30.0% vol.	OFF	OFF
0 - 100% vol.	1% vol.	OFF	OFF	OFF	OFF

Description

The infrared CO₂ sensor is a smart sensor that stores sensor parameters including the target gas and detection range. So you can change an existing infrared CO₂ channel from one range to another and the EAGLE 3 will automatically load all the sensor parameters and configure the infrared CO₂ channel for the new sensor without the need to enter **Configure Channels** or **Configure Gases** in Setup Mode. See page 229 for instructions to replace or change an infrared CO₂ sensor.

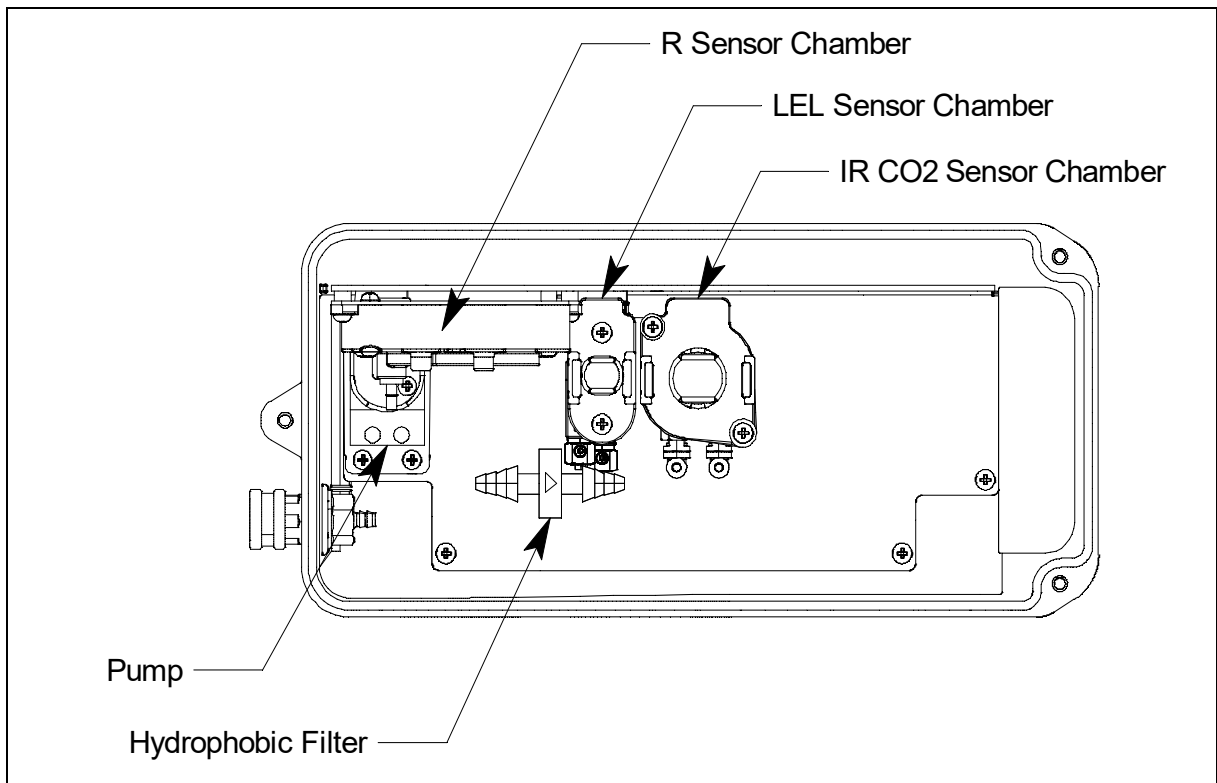

Figure 41: Typical IR CO₂ Sensor Location

The infrared CO₂ sensor is installed in a single sensor flow chamber which is located in the area next to the LEL sensor chamber. This area can accommodate up to three single sensor flow chambers. Figure 41 above illustrates a typical infrared CO₂ sensor location. The infrared CO₂ flow chamber may also be installed in one of the other two sensor chamber locations depending on the particular version of the EAGLE 3. Some infrared CO₂ instrument configurations do not include the LEL sensor chamber.

Infrared CO₂ Sensor

The IRF sensor is a cylindrical sensor with a diffusion opening on the front and a connector on the back. The connector mates to the an adapter PCB that's installed on the bottom of the sensor retainer to keep the sensor in place. This sensor adapter slots into a connector on the main PCB when the sensor is installed into its flow chamber using the two retaining screws.

CO₂ Scrubber

A carbon dioxide scrubber is mounted to the exterior side of EAGLE 3s that are factory-shipped with carbon dioxide sensors in the 10,000 ppm, 10.00% vol, and 20.00% vol ranges. EAGLE 3s that ship with a 0 - 60.0% vol. or 0 - 100% vol. sensor do not include a CO₂ scrubber.

This scrubber is for use when setting the carbon dioxide sensor's zero reading only. Two black vinyl caps cover either end of the carbon dioxide scrubber. To prolong the life of the scrubber, be sure the caps are installed while the scrubber is not in use or while it is being stored. Replace the scrubber when it turns from white to a violet color.

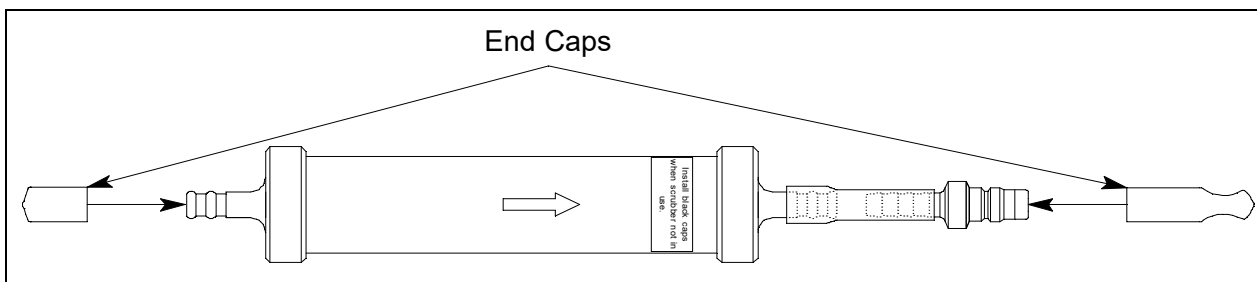

Figure 42: Carbon Dioxide Scrubber

Start Up and Normal Operation

For instructions to warmup and use an EAGLE 3 that includes an infrared CO₂ sensor, reference “Start Up” on page 30, “Normal Mode Operation” on page 43, and “Alarms” on page 52.

Follow these instructions keeping the following special considerations in mind:

- A background level of CO₂ exists in fresh air. The 10,000 ppm, 10.00% vol, and 20.00% vol range sensors will display a reading of 400 ppm/0.04% volume in fresh air.
- When you perform a demand zero on a 10,000 ppm, 10.00% vol, or 20.00% vol range sensor during start up, operation, or calibration, you must use the CO₂ scrubber provided with the instrument to remove background CO₂ from the air being sampled. See Performing a Demand Zero for Carbon Dioxide Sensors below. The 60.0% vol and 100% vol range sensors do not need a CO₂ scrubber to perform a fresh air zero.
- Since there is a background of CO₂ in air, do not use the Auto Zero feature that can be turned on and off in Setup Mode. The factory setting for the feature is off.

Performing a Demand Zero for Carbon Dioxide Sensors

When setting the zero reading, the carbon dioxide scrubber mounted to the side of the EAGLE 3 allows you to eliminate carbon dioxide normally found in fresh air. To perform a demand zero, do the following:

1. Remove the black caps from the ends of the carbon dioxide scrubber. Be sure to grab the scrubber by the EAGLE 3 fitting so that the fitting and tubing do not come off.
2. Connect the carbon dioxide scrubber directly to the EAGLE 3's inlet fitting.

3. If you also have a low-range PID sensor installed and suspect any low-level VOC background in the area, you must install the VOC zero filter before performing a demand zero.
 - a. Remove the plug from each end of the VOC zero filter.
 - b. Attach the VOC zero filter to the probe. The filter does not have a preferred flow direction.
 - c. Connect the CO₂ scrubber's fitting to the VOC zero filter.

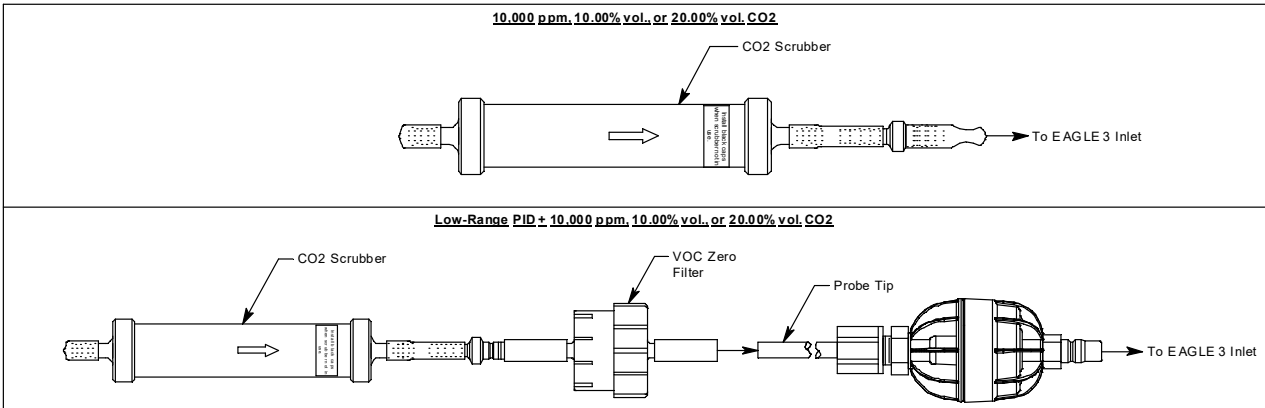

4. Wait one minute, then press **AIR** to set the zero reading.
5. Remove the scrubber from the inlet fitting or from the VOC zero filter if you used one.
6. Put the caps back on the scrubber.
7. If you used a VOC zero filter, remove it from the probe and reinstall the plugs.

Infrared CO₂ Calibration

In order to fully calibrate the IR CO₂ sensor, both of the following must be performed:

1. A zero performed in “CO₂ Zero Calibration” menu as described on pg. 87
2. A span adjustment as described on pg. 89

Maintenance

This section includes a procedure for replacing an infrared CO₂ sensor.

CAUTION: *After the EAGLE 3 case is opened, check that all pump tubing is securely connected and there are no kinks in the lines before securing the top case.*

Replacing the IR CO₂ Sensor or Changing Sensor Type

1. Verify that the EAGLE 3 is off.

2. Place the EAGLE 3 upside down on a flat surface or hold it upside down.
3. Unscrew the three case screws until they disengage from the top case. They are captive screws so they will not fall off of the bottom case.
4. Turn the EAGLE 3 right side up and carefully lift the top case away from the bottom case. Be careful not to lift it so far that it pulls on the main PCB with the cable that connects the top case to the main PCB.
5. Lay the top case down next to the bottom case to allow access to the flow system.
6. Locate the infrared CO₂ sensor and retainer. Figure 41 on page 227 shows an infrared CO₂ sensor in a typical location.
7. Unscrew and remove the two screws that hold down the sensor retainer.

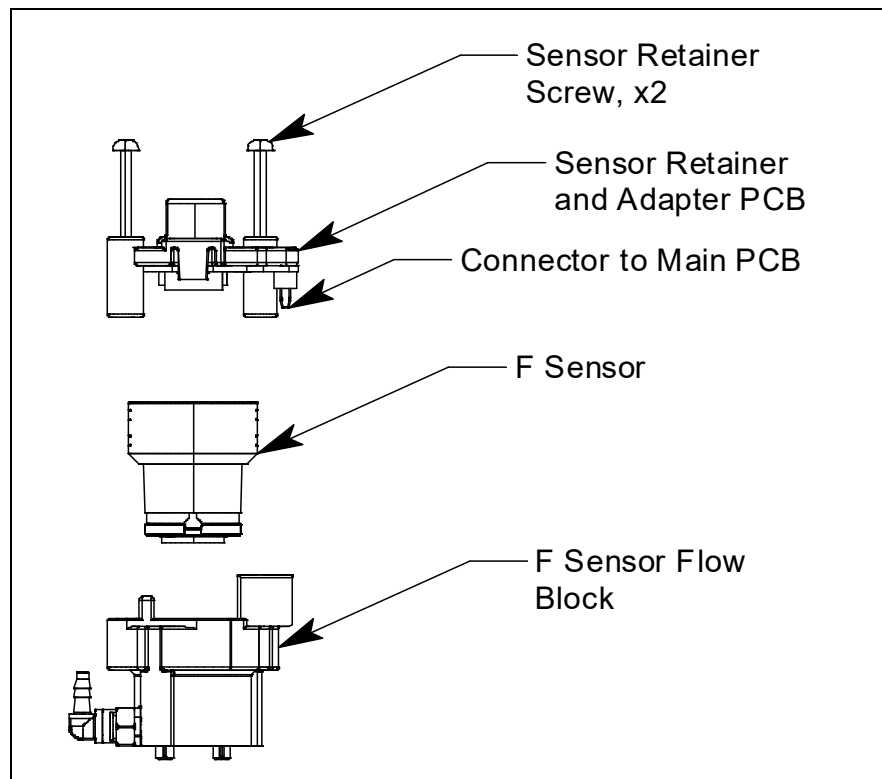

Figure 43: Replacing a Sensor

8. Grasp the retainer and sensor firmly and hold down the side of the case with the main PCB, then pull the sensor and retainer out of the flow chamber. Unplug the old infrared CO₂ sensor from the sensor adapter PCB on the bottom of the retainer.
9. Plug the new infrared CO₂ sensor into the sensor adapter PCB.
10. Insert the sensor and retainer into the infrared CO₂ flow chamber, ensuring the retainer is aligned with the two standoffs and the sensor adapter PCB is aligned with the main PCB connector.

11. Screw the two sensor retainer screws by alternately tightening them to push the sensor into its chamber and the sensor adapter PCB into the main PCB connector evenly.
12. Confirm that the main PCB is seated in its slots and that its bottom edge is resting on the bottom of the bottom case. If the main PCB is not seated properly, it may be damaged when the top case is re-installed.
13. Ensure that all internal tubing is connected without any pinched lines.
14. Make sure that the top case gasket is fully seated in its groove and carefully put the top case back on the bottom case. If you have any difficulty mating the top and bottom cases, inspect the placement of the main PCB and the placement of the top case gasket.
15. Turn the EAGLE 3 upside down and tighten the three case screws to secure the top case to the bottom case. Screws should be tightened to a torque of at least 30 N/cm.
16. Calibrate the infrared CO₂ channel as described on page 229.

IR CO₂ EAGLE 3 Parts List

Part Number	Description
33-6010RK-01	CO ₂ scrubber
81-0073RK-01	Calibration cylinder, 15% vol CO ₂ in nitrogen, 34 liter steel
81-0073RK-03	Calibration cylinder, 15% vol CO ₂ in nitrogen, 103 liter
IRF-4433	Infrared CO ₂ sensor, 0 - 10,000 ppm
IRF-4439	Infrared CO ₂ sensor, 0 - 10% vol.
IRF-4443	Infrared CO ₂ sensor, 0 - 20% vol.
IRF-4444	Infrared CO ₂ sensor, 0 - 60% vol.
IRF-4457	Infrared CO ₂ sensor, 0 - 100% vol.

Appendix G: Infrared Methane Sensor

Overview

This appendix describes the EAGLE 3's infrared combustible gas sensors and includes instructions to use an EAGLE 3 that has an infrared combustible gas sensor installed. It also includes instructions to replace an infrared combustible gas sensor.

Table 26: Infrared Combustible Gas Sensor Specifications

Target Gas	Range	Increment	Alarm 1	Alarm 2	STEL	TWA
Methane (CH ₄)	0 - 100% LEL	0.5% LEL	10% LEL	50% LEL	OFF	OFF
	5.0 - 100.0% vol.	0.1% vol.	OFF	OFF	OFF	OFF

Target Gases

The infrared combustible gas sensor is setup for and factory-calibrated to methane. There are gases that the sensor will still detect and respond to. There are also gases that the methane sensor will not detect or respond to. Lists of the gases falling in each of these respective categories can be found below. Consult with RKI Instruments, Inc. for combustible gases not listed below.

The infrared combustible gas sensor is known to respond to the following combustible gases:

- ethane
- hexane
- IPA
- isobutane
- MEK
- propane
- styrene
- toluene

The infrared combustible gas sensor is known to not or to poorly respond to the following combustible gases:

- acetylene
- benzene
- hydrogen

Description

Table 26 lists the available infrared methane sensor configurations. The infrared methane sensor is a smart sensor that stores the target gas.

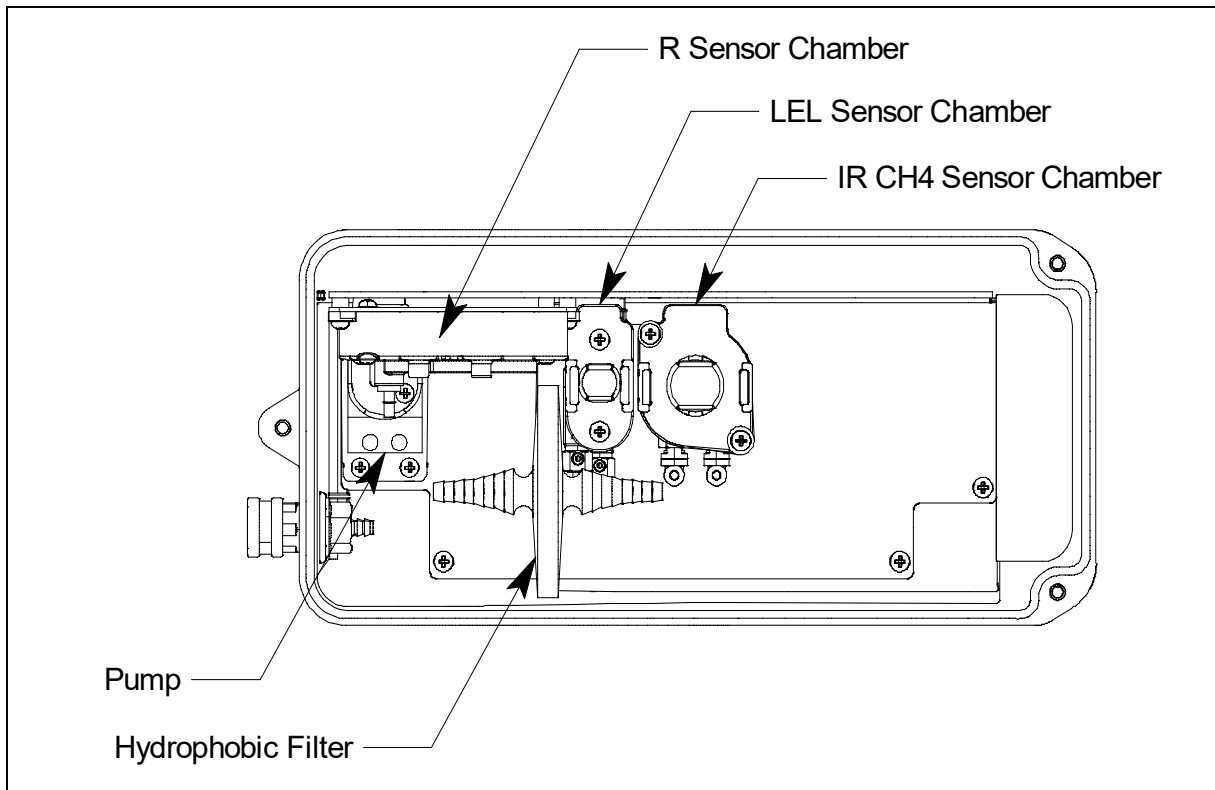

Figure 44: Typical IR Methane Sensor Location

The infrared methane sensor is installed in a single sensor flow chamber which is located in the area next to the LEL sensor chamber. This area can accommodate up to three single sensor flow chambers. Figure 44 above illustrates a typical infrared methane sensor location. The infrared methane flow chamber may also be installed in one of the other two sensor chamber locations depending on the particular version of the EAGLE 3. Some infrared methane instrument configurations do not include the LEL sensor chamber.

Infrared Methane Sensor

The IRF sensor is a cylindrical sensor with a diffusion opening on the front and a connector on the back. The connector mates to the an adapter PCB that's installed on the bottom of the sensor retainer to keep the sensor in place. This sensor adapter slots into a connector on the main PCB when the sensor is installed into its flow chamber using the two retaining screws.

Start Up and Normal Operation

For instructions to warmup and use an EAGLE 3 that includes an infrared combustible gas sensor, reference “Start Up” on page 30, “Normal Mode Operation” on page 43, and “Alarms” on page 52.

Detection Ranges

The infrared combustible gas sensor detects gas on a 0-100% LEL and a 5.0-100.0% vol scale. The gas reading will be displayed in % LEL until the gas level reaches 100 % LEL, or 5.0% vol for methane. Once the gas reading is above 100 % LEL, it is displayed in %vol. Alarm points exist for the % LEL range but do not exist for the %vol range.

Catalytic (LEL) Sensor Screen

When either a TC sensor or an infrared combustible sensor is installed in an EAGLE 3 along with a catalytic combustible LEL sensor, the user has the option of turning off the catalytic combustible LEL sensor in Display Mode. If the unit is going to be used for sampling known high-levels of combustible gas or in areas with known catalytic sensor poisons such as silicone vapors, the catalytic combustible sensor should be turned off. Even though this sensor has its own protective shut off, exposure to high levels of combustible gas can still stress the catalytic LEL sensor. The catalytic LEL sensor can be enabled or disabled in the Catalytic (LEL) Sensor screen in Display Mode. The default setting is enabled. To change the setting, do the following:

NOTE: The Catalytic (LEL) Sensor setting is reset when the EAGLE 3 is turned off. When the EAGLE 3 is turned on, this setting is always ENABLED.

1. Use the **DISPLAY** button to enter Display Mode and scroll to the Catalytic (LEL) Sensor screen. Press **POWER** to enter the menu.



2. Use the **AIR** or **RANGE** button to toggle to the desired setting. If set to **DISABLED**, the gas readings for the catalytic LEL channel will be replaced by dashes (---).
3. Press **POWER** to save the setting and return to the main menu.
4. Use the **DISPLAY** button to scroll through the rest of Display Mode and enter Normal Operation.

Infrared Methane Calibration

See “Chapter 5: Calibration Mode” on page 79 for calibration instructions.

The standard factory calibration for the autoranging infrared combustible gas sensor is to 50 % LEL. If your instrument is configured for autoranging and you need maximum accuracy in the %vol range, the sensor may be calibrated to 50% vol.

Maintenance

This section includes a procedure to replace an infrared combustible gas sensor.

CAUTION: *After the EAGLE 3 case is opened, check that all pump tubing is securely connected and there are no kinks in the lines before securing the top case.*

Replacing the IR Methane Sensor

1. Verify that the EAGLE 3 is off.
2. Place the EAGLE 3 upside down on a flat surface or hold it upside down.
3. Unscrew the three case screws until they disengage from the top case. They are captive screws so they will not fall off of the bottom case.
4. Turn the EAGLE 3 right side up and carefully lift the top case away from the bottom case. Be careful not to lift it so far that it pulls on the main PCB with the cable that connects the top case to the main PCB.
5. Lay the top case down next to the bottom case to allow access to the flow system.
6. Locate the infrared combustible gas sensor and retainer. Figure 44 on page 233 shows an infrared combustible gas sensor in a typical location.

7. Unscrew and remove the two screws that hold down the sensor retainer.

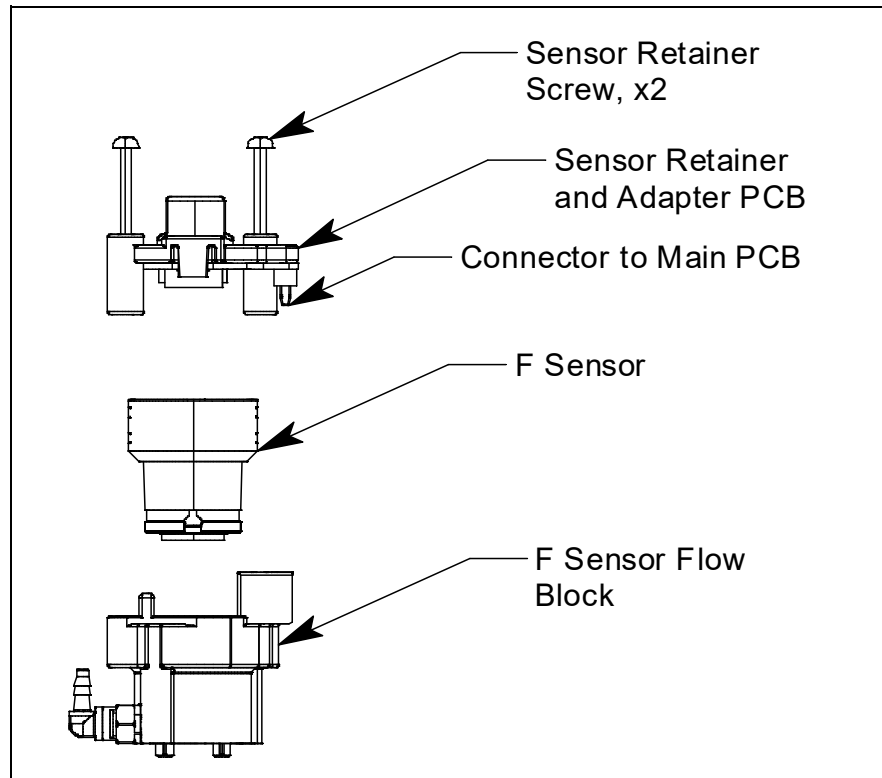

Figure 45: Replacing a Sensor

8. Grasp the retainer and sensor firmly and hold down the side of the case with the main PCB, then pull the sensor and retainer out of the flow chamber. Unplug the old infrared combustible gas sensor from the sensor adapter PCB on the bottom of the retainer.
9. Plug the new infrared combustible gas sensor into the sensor adapter PCB.
10. Insert the sensor and retainer into the infrared methane flow chamber, ensuring the retainer is aligned with the two standoffs and the sensor adapter PCB is aligned with the main PCB connector.
11. Screw the two sensor retainer screws by alternately tightening them to push the sensor into its chamber and the sensor adapter PCB into the main PCB connector evenly.
12. Confirm that the main PCB is seated in its slots and that its bottom edge is resting on the bottom of the bottom case. If the main PCB is not seated properly, it may be damaged when the top case is re-installed.
13. Ensure that all internal tubing is connected without any pinched lines.
14. Make sure that the top case gasket is fully seated in its groove and carefully put the top case back on the bottom case. If you have any difficulty mating the top and bottom cases, inspect the placement of the main PCB and the placement of the top case gasket.
15. Turn the EAGLE 3 upside down and tighten the three case screws to secure the top case to the bottom case. Screws should be tightened to a torque of at least 30 N/cm.
16. Calibrate the infrared methane channel as described on page 235.

IR CH₄ EAGLE 3 Parts List

Part Number	Description
IRF-4341	Infrared CH ₄ sensor, 0-100 % LEL or 0-100 % LEL/5.0-100.0% vol autoranging
81-0012RK-01	Calibration cylinder, 50% LEL CH ₄ in air, 34 liter steel
81-0012RK-03	Calibration cylinder, 50% LEL CH ₄ in air, 103 liter
81-0013RK-01	Calibration cylinder, 50% vol CH ₄ in N ₂ , 34 liter steel
81-0013RK-05	Calibration cylinder, 50% vol CH ₄ in N ₂ , 58 liter

Appendix H: Infrared Hydrocarbon Sensor

Overview

This appendix describes the EAGLE 3's infrared hydrocarbon sensor and includes instructions to use an EAGLE 3 that has an infrared hydrocarbon sensor installed. It also includes instructions to replace an infrared hydrocarbon sensor.

Table 27: Infrared Hydrocarbon Sensor Specifications, Autoranging Configuration

Range	Increment	Alarm 1	Alarm 2	STEL	TWA
0 - 100% LEL HC	0.5% LEL	10% LEL	50% LEL	OFF	OFF
1.8 - 100.0% vol. HC	0.1% vol.	OFF	OFF	OFF	OFF

NOTE: The gas name on the infrared hydrocarbon channel will normally read "HC". However, depending on the instrument's shipment date and any special requirements, your instrument may read "IBU" or some other gas name.

Target Gases

The infrared HC sensor is a general hydrocarbon sensor. It is setup for and factory-calibrated to isobutane.

Description

The infrared hydrocarbon sensor is a smart sensor that stores the target gas. The infrared hydrocarbon sensor is installed in a single sensor flow chamber which is located in the area next to the LEL sensor chamber. This area can accommodate up to three single sensor flow chambers. Figure 46 above illustrates a typical infrared hydrocarbon sensor location. The infrared hydrocarbon flow chamber may also be installed in one of the other two sensor chamber locations depending on the particular version of the EAGLE 3. Some infrared hydrocarbon instrument configurations do not include the LEL sensor chamber.

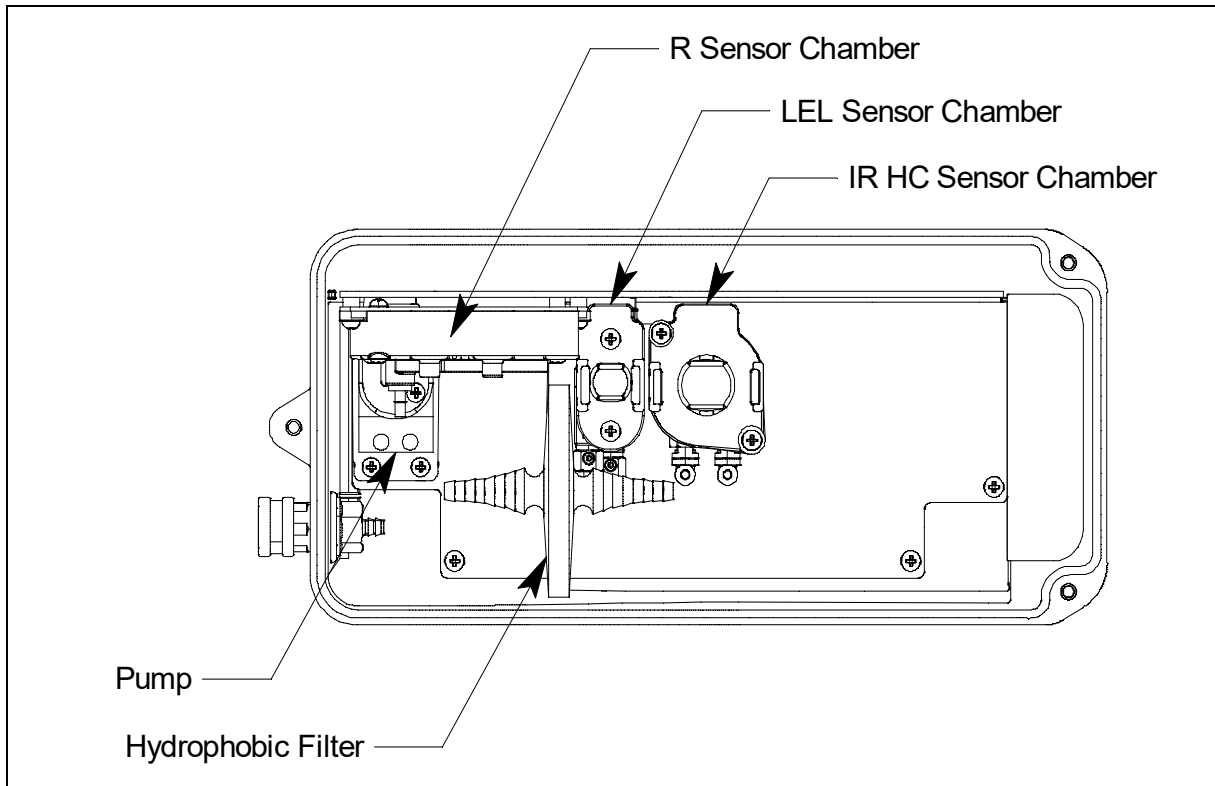

Figure 46: Typical IR HC Sensor Location

Infrared Hydrocarbon Sensor

The IRF sensor is a cylindrical sensor with a diffusion opening on the front and a connector on the back. The connector mates to the an adapter PCB that's installed on the bottom of the sensor retainer to keep the sensor in place. This sensor adapter slots into a connector on the main PCB when the sensor is installed into its flow chamber using the two retaining screws.

Start Up and Normal Operation

For instructions to warmup and use an EAGLE 3 that includes an infrared hydrocarbon sensor, reference “Start Up” on page 30, “Normal Mode Operation” on page 43, and “Alarms” on page 52.

0 - 100% LEL/1.8 - 100.0% vol. Autoranging

The infrared hydrocarbon sensor detects gas on a 0 - 100% LEL and a 1.8 - 100.0% vol scale. The gas reading will be displayed in %LEL until the gas level reaches 100% LEL, or 1.8% vol. for isobutane. Once the gas reading is above 100% LEL, it is displayed in %vol. Alarm points exist for the %LEL range but do not exist for the %vol range.

Catalytic (LEL) Sensor Screen

When either a TC sensor or an infrared combustible sensor is installed in an EAGLE 3 along with a catalytic combustible LEL sensor, the user has the option of turning off the catalytic combustible LEL sensor in Display Mode. If the unit is going to be used for sampling known high-levels of combustible gas or in areas with known catalytic sensor poisons such as silicone vapors, the catalytic combustible sensor should be turned off. Even though this sensor has its own protective shut off, exposure to high levels of combustible gas can still stress the catalytic LEL sensor. The catalytic LEL sensor can be enabled or disabled in the Catalytic (LEL) Sensor screen in Display Mode. The default setting is enabled. To change the setting, do the following:

NOTE: The Catalytic (LEL) Sensor setting is reset when the EAGLE 3 is turned off. When the EAGLE 3 is turned on, this setting is always ENABLED.

1. Use the **DISPLAY** button to enter Display Mode and scroll to the Catalytic (LEL) Sensor screen. Press **POWER** to enter the menu.



1. Use the **AIR** or **RANGE** button to toggle to the desired setting.
If set to DISABLED, the gas reading for the catalytic LEL channel will be replaced by dashes (---).
2. Press **POWER** to save the setting and return to the main menu.
3. Use the **DDISPLAY** button to scroll through the rest of Display Mode and enter Normal Operation.

Infrared Hydrocarbon Calibration

See “Chapter 5: Calibration Mode” on page 79 for calibration instructions.

The standard factory calibration for the autoranging infrared hydrocarbon sensor is to 50% LEL isobutane. If you need maximum accuracy in the %vol. range, the sensor may be calibrated to 10% vol. isobutane.

Maintenance

This section includes a procedure to replace an infrared hydrocarbon sensor.

CAUTION: *After the EAGLE 3 case is opened, check that all pump tubing is securely connected and there are no kinks in the lines before securing the top case.*

Replacing the IR Hydrocarbon Sensor

1. Verify that the EAGLE 3 is off.
2. Place the EAGLE 3 upside down on a flat surface or hold it upside down.
3. Unscrew the three case screws until they disengage from the top case. They are captive screws so they will not fall off of the bottom case.
4. Turn the EAGLE 3 right side up and carefully lift the top case away from the bottom case. Be careful not to lift it so far that it pulls on the main PCB with the cable that connects the top case to the main PCB.
5. Lay the top case down next to the bottom case to allow access to the flow system.
6. Locate the infrared hydrocarbon sensor and retainer. Figure 46 on page 239 shows an infrared hydrocarbon sensor in a typical location.

7. Unscrew and remove the two screws that hold down the sensor retainer.

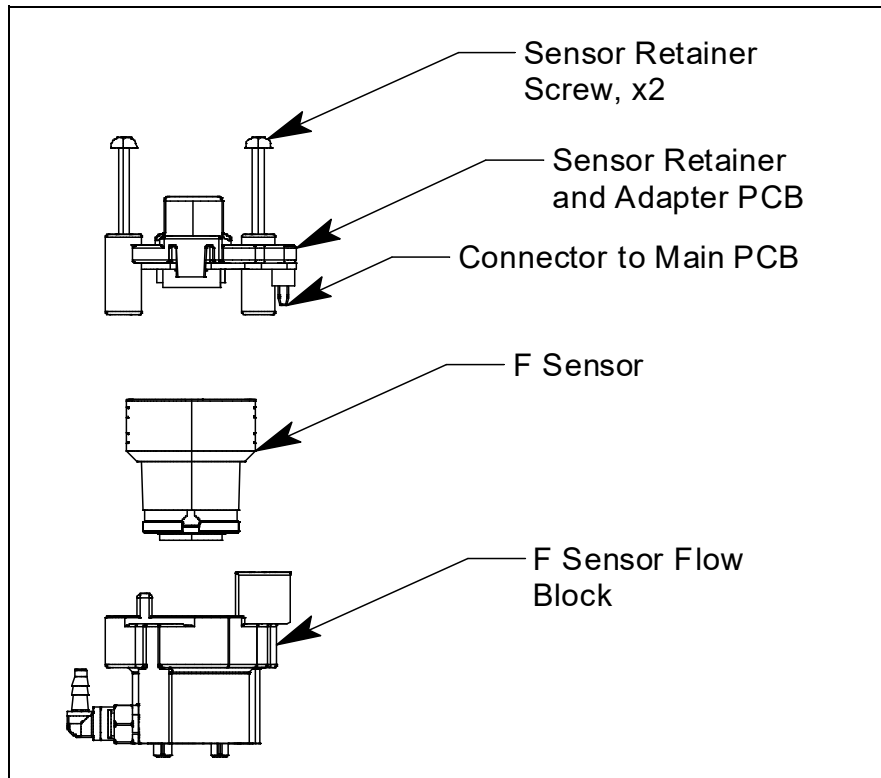

Figure 47: Replacing a Sensor

8. Grasp the retainer and sensor firmly and hold down the side of the case with the main PCB, then pull the sensor and retainer out of the flow chamber.
9. Unplug the old infrared hydrocarbon sensor from the sensor adapter PCB on the bottom of the retainer.
10. Plug the new infrared hydrocarbon sensor into the sensor adapter PCB.
11. Insert the sensor and retainer into the infrared hydrocarbon flow chamber, ensuring the retainer is aligned with the two standoffs and the sensor adapter PCB is aligned with the main PCB connector.
12. Screw the two sensor retainer screws by alternately tightening them to push the sensor into its chamber and the sensor adapter PCB into the main PCB connector evenly.
13. Confirm that the main PCB is seated in its slots and that its bottom edge is resting on the bottom of the bottom case. If the main PCB is not seated properly, it may be damaged when the top case is re-installed.
14. Ensure that all internal tubing is connected without any pinched lines.
15. Make sure that the top case gasket is fully seated in its groove and carefully put the top case back on the bottom case. If you have any difficulty mating the top and bottom cases, inspect the placement of the main PCB and the placement of the top case gasket.

16. Turn the EAGLE 3 upside down and tighten the three case screws to secure the top case to the bottom case. Screws should be tightened to a torque of at least 30 N/cm.
17. Calibrate the infrared hydrocarbon channel as described on page 240.

IR HC EAGLE 3 Parts List

Table 28: IR HC Parts List

Part Number	Description
IRF-4345	Infrared HC sensor, 0 - 100% LEL/2.0 - 30.0% vol autoranging
81-0018RK-01	Calibration cylinder, 50% LEL isobutane in air, 34 liter steel
81-0018RK-03	Calibration cylinder, 50% LEL isobutane in air, 103 liter
81-0019RK	Calibration cylinder, 10% volume isobutane in nitrogen, 17 liter

Appendix I: Methane Elimination Mode

Overview

For applications where methane is an interfering gas, you can set the EAGLE 3 to eliminate most response to methane using methane elimination mode.

CAUTION: *The EAGLE 3 catalytic combustible sensor experiences a significant gas response drop when it is changed from full response mode to methane elimination mode. The EAGLE 3 must be calibrated in both full response mode and in methane elimination mode to account for this. See “Calibration” on page 246 for further instructions.*

Monitoring in Methane Elimination Mode

To monitor an area using methane elimination mode, do the following:

1. Turn on the EAGLE 3 as described in “Start Up” on page 30.
2. Make sure that the EAGLE 3 catalytic combustible channel is set to monitor a gas in which methane elimination is an option. For a list of these gases and a procedure to select one, see page 123. A common target gas is hexane. Once a gas that allows for methane elimination is selected for the catalytic combustible channel, the methane elimination mode screen becomes part of Display Mode.
3. Press **DISPLAY** to enter Display Mode and to scroll through the screens until you reach the Methane Elimination Mode screen.

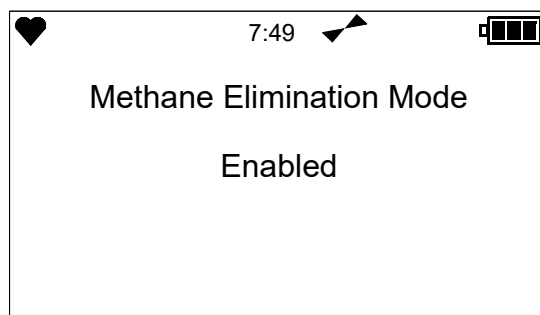

4. Press **POWER** to enter the menu. The cursor will be next to the current setting.

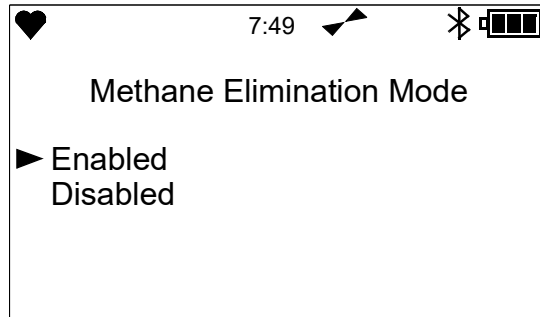

5. Press **AIR** or **RANGE** to move the cursor to **Enabled**.
6. Press **POWER** to save the setting.
7. You will note that if methane elimination is enabled, the Catalytic Sensor Relative Response screen no longer appears even if the relative response feature in Setup Mode is turned on. While methane elimination is enabled, the Catalytic Sensor Relative Response screen will not appear in Display Mode even if the relative response feature in Setup Mode is enabled.
8. Continue to press **DISPLAY** until the Normal Mode screen appears.

CH4 %LEL	O2 %	CO ppm
0	20.9	0
H2S ppm	NH3 ppm	
0.0	0.0	

9. Allow 2 minutes for the combustible sensor to stabilize.
10. Perform a demand zero. See page 41 for instructions.
11. Monitor for the target gas.
12. To return to full response mode, return to the Methane Elimination Mode screen in Display Mode and press the **AIR** or **RANGE** button to toggle the setting to **DISABLED**.
13. Press the **POWER** button. The unit will save the setting and proceed to the next menu item.

14. Continue to press the DISPLAY button until the Normal Mode screen appears.

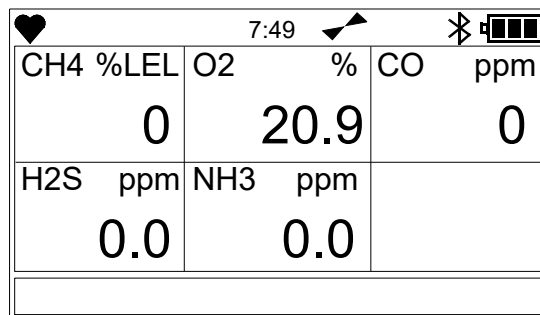

The screenshot shows the Normal Mode screen of the EAGLE 3 instrument. At the top, there is a status bar with a heart icon, the time 7:49, a signal strength indicator, a Bluetooth icon, and a battery level indicator. Below this is a table of gas readings:

CH4 %LEL	O2 %	CO ppm
0	20.9	0
H2S ppm	NH3 ppm	
0.0	0.0	

The ME is no longer next to the catalytic combustible channel reading indicating that the unit is measuring in full response mode.

15. Allow 2 minutes for the combustible sensor to stabilize before monitoring the target gas.

16. Perform a demand zero. See “Performing a Demand Zero” on page 41 for instructions.

17. Monitor for the target gas.

NOTE: The EAGLE 3 retains the methane elimination mode setting when it is turned off. The methane elimination mode setting, ENABLED or DISABLED, will remain in effect until it is changed in Display Mode. So if methane elimination mode is enabled when you turn off the EAGLE 3, it will remain enabled when you turn the EAGLE 3 on again.

Calibration

The EAGLE 3 stores calibration data for the instrument both in methane elimination mode and in full response mode. When using the instrument for applications where methane elimination mode is used, it is most common to calibrate to hexane. If you are planning to use the EAGLE 3 in methane elimination mode, RKI Instruments, Inc. recommends that you setup and calibrate the instrument to hexane in both full response and methane elimination mode unless your application requires a different setup and calibration. See “Configuring the Gases (Configure Gases)” on page 123 for instructions to setup the catalytic combustible channel gas.

CAUTION: *The EAGLE 3 catalytic combustible sensor experiences a significant gas response drop when it is changed from full response mode to methane elimination mode. The EAGLE 3 must be calibrated in both full response mode and in methane elimination mode to account for this.*

To properly calibrate the instrument, do the following:

1. With the EAGLE 3 catalytic combustible channel set up for hexane, perform a demand zero and a calibration while in full response. See “Chapter 5: Calibration Mode” on page 79 for instructions.
2. Enable methane elimination in Display Mode.

3. Allow the unit to stabilize for 2 minutes.
4. Perform a demand zero and a calibration while in methane elimination mode. See page 79 for instructions.

Appendix J: Using the EAGLE 3 in Bar Hole Mode

Overview

This chapter explains how to operate the EAGLE 3 in Bar Hole Mode. Bar Hole Mode is used to perform consistent checks of bar holes when tracking down underground gas leaks. When the EAGLE 3 is in Bar Hole Mode, only the combustible and oxygen sensors are displayed.

If an EAGLE 3 is intended for bar hole testing, it is shipped with Bar Hole Mode or both Bar Hole Mode and Leak Check Mode enabled so that the operator must choose which operational mode to use when the unit is turned on (see page 162).

Start Up, Bar Hole Mode

This section explains how to start up the EAGLE 3 in Bar Hole Mode and get it ready for operation.

Turning On the EAGLE 3, Bar Hole Mode

WARNING: *If one or more sensors other than a catalytic LEL, TC, or oxygen sensor is installed, these sensors will not be active while the EAGLE 3 is in Bar Hole Mode.*

WARNING: *Gas alarms are not active when the EAGLE 3 is in Bar Hole Mode.*

The following description of the EAGLE 3 start up sequence assumes that the following menu items in Setup Mode are turned on: **Cal Reminder** and **User/Station ID**. If either of these items is turned off, then the corresponding screen will not appear.

NOTE: In order for **Bar Hole Mode** to appear as a selection in the **Mode Select** screen in Step 3 below, the EAGLE 3 must have both a catalytic LEL sensor and a TC sensor installed. In addition, both the catalytic LEL and TC channels must be configured for methane, CH₄, in the **Configure Gases** menu item in **Setup Mode**. If an EAGLE 3 has only the catalytic LEL sensor installed or if the TC channel is configured for a gas other than CH₄, then **Bar Hole Mode** will not appear as a choice as shown in Step 3 below and **Normal Mode** and **Leak Check Mode** will be the only choices displayed. In this case, see “Turning On the EAGLE 3” on page 30 or “Turning On the EAGLE 3, Leak Check Mode” on page 257.

1. Connect the sample hose to the EAGLE 3’s quick connect inlet fitting.
2. Connect the bar hole probe to the sample hose’s quick connect fitting.

3. Press and briefly hold down the POWER button. Release the button when you hear a beep.
4. The LCD will show the following screen for about ten seconds.



5. The **Date/Time** screen appears for a few seconds.

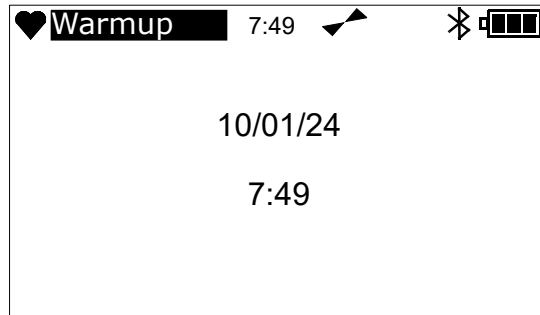

6. The **Battery Voltage** screen appears for a few seconds.

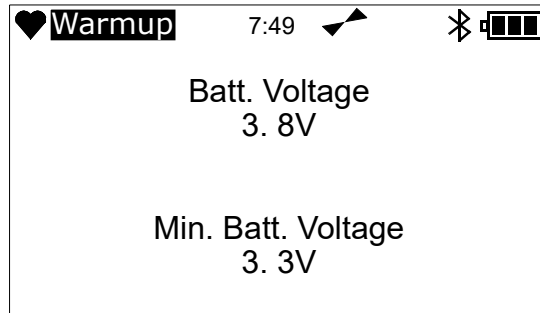

7. After the alarm screens, if **Cal Reminder** is turned on, the screen that appears next depends on how **Cal Past Due Act** is set in the Setup Mode Menu (see page 148).

- If the unit is due for calibration and **Cal Past Due Act** is set to **Confirm to Cal**, then the following screen displays and the buzzer sounds in a double pulsing pattern.

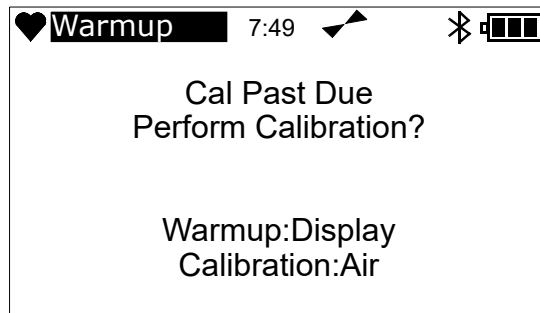

- To perform a calibration, press the AIR button. The EAGLE 3 will enter Calibration Mode and the LCD will show the Calibration Mode main menu. See page 79 for instructions to calibrate the EAGLE 3. When you are done with the calibration and exit Calibration Mode, the unit will begin the warmup sequence. If the calibration was successful, the screen above will not appear again until the unit is due for calibration. If the calibration was not successful, the screen above will again appear in the warmup sequence.
- To continue without performing a calibration, press the DISPLAY button.
- If the unit is due for calibration and **Cal Past Due Act** is set to **Must Calibrate**, then the following screen displays and the buzzer sounds in a double pulsing pattern.

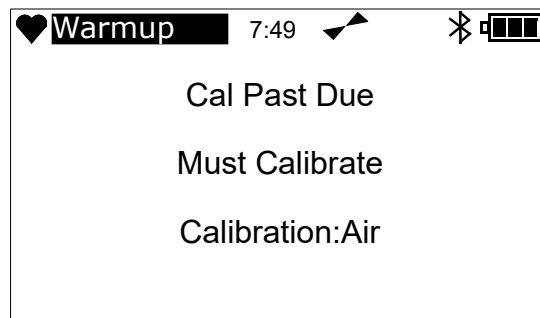

- The EAGLE 3 cannot be used until a successful calibration has been performed. Press the ENTER button to enter Calibration Mode. See page 79 for instructions to calibrate the EAGLE 3. When you are done with the calibration and exit Calibration Mode, the unit will begin the warmup sequence. If the calibration was successful, the screen above will not appear again until the unit is due for calibration. If the calibration was not successful, the screen above will again appear in the warmup sequence.
- If the unit is due for calibration and **Cal Past Due Act** is set to **None**, then the following alert screen displays and the buzzer sounds in a double pulsing pattern.

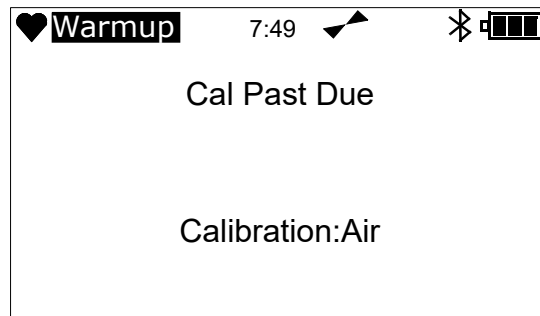

Press the POWER button to acknowledge the alert and continue with the warmup sequence.

8. The Mode Select screen displays.

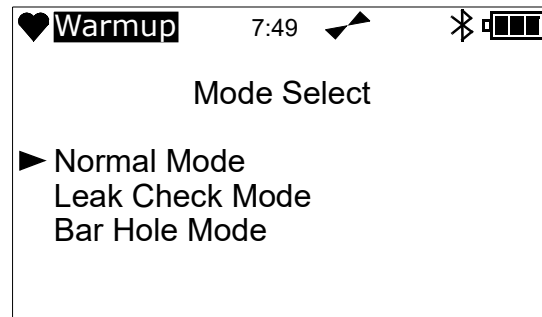

9. The cursor will flash in front of **Normal Mode**. Use the RANGE button to move the cursor next to **Bar Hole Mode**.

10. With Bar Hole Mode selected, press the POWER button to begin the Bar Hole Mode warmup sequence.

NOTE: If no button is pressed for 20 seconds, the unit will proceed into whichever mode has the cursor in front of it.

11. The **Gas Name** screen appears for a few seconds indicating the channel gas names.

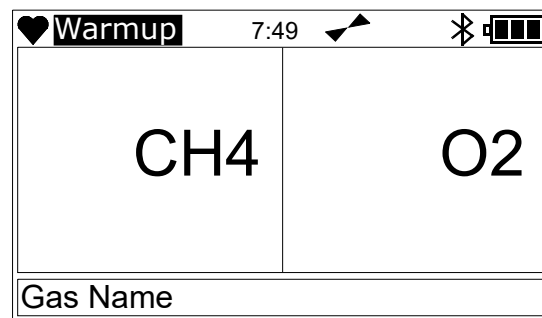

12. The instrument displays each channels' full scales and alarm setpoints in the following sequence: the full scale screen, the Alarm 1 screen, Alarm 2 screen, STEL, and TWA alarm screen. Each screen remains on the LCD for three seconds.

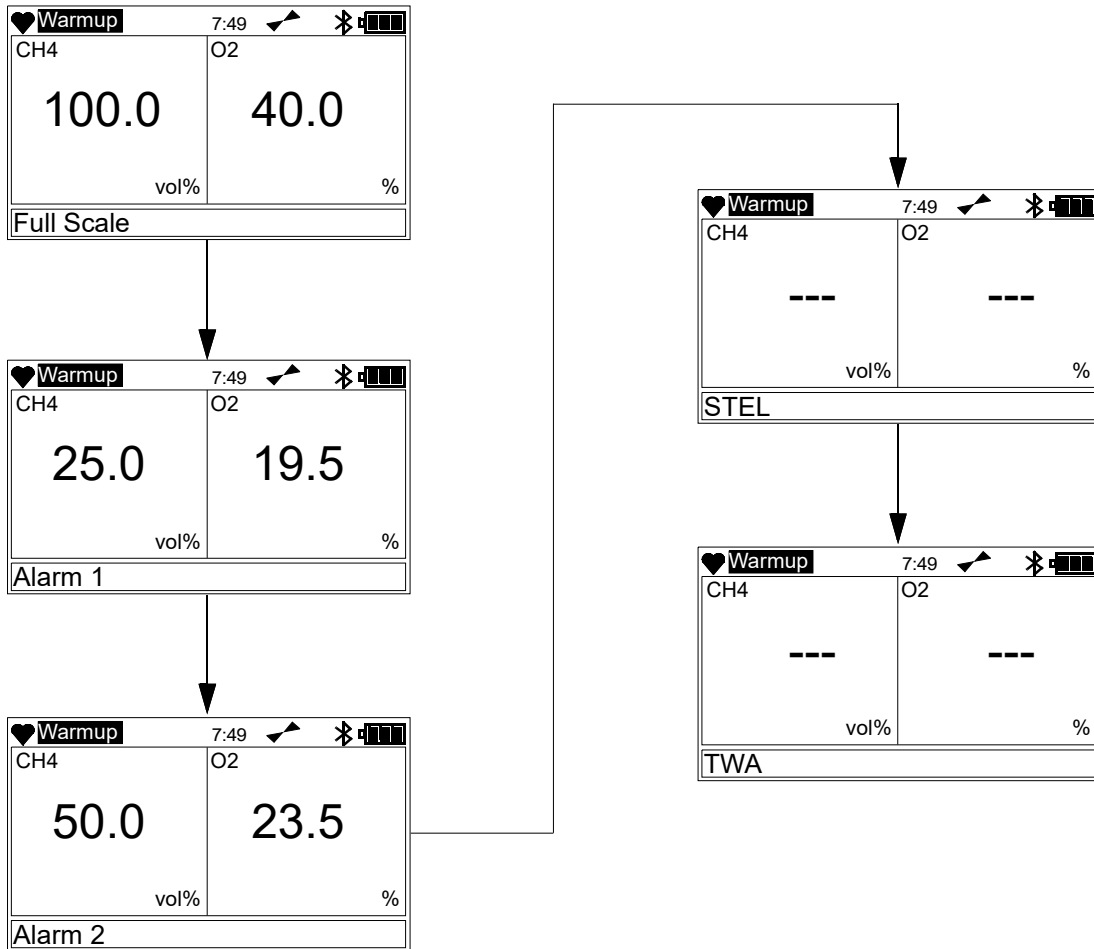

13. If **User/Station ID** is turned on (see page 138), the ID Screen appears for a few seconds.

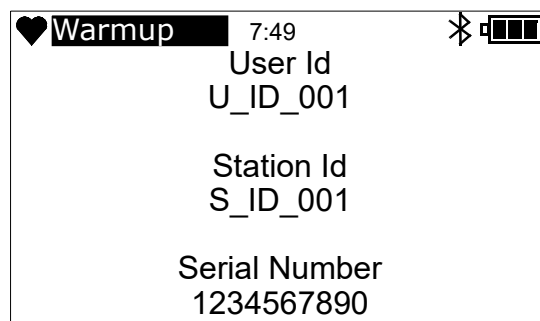

If **User/Station ID** is turned off, only the serial number is shown.

14. If the EAGLE 3 experiences a sensor failure during start up, a screen indicating which sensor failed appears, flashes “FAIL”, and the buzzer sounds a pulsing tone twice per second.

In the example below, the catalytic combustible gas sensor has failed.

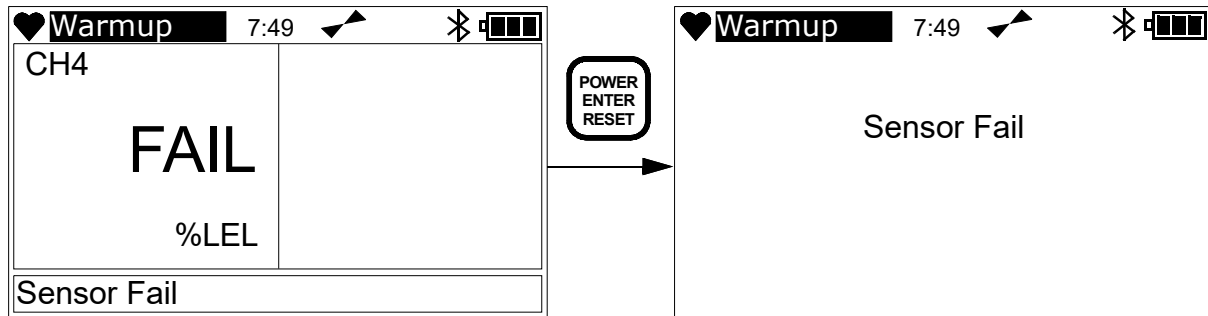

If one of the combustible sensors, LEL or TC, fails, it is not possible to enter Bar Hole Mode. Press the POWER button to acknowledge the failure, and the instrument restarts the warmup sequence then returns to the Mode Select screen. Turn off the instrument and replace the failed sensor.

If the oxygen sensor fails, press the POWER button to acknowledge the failure and continue to Bar Hole Mode. The gas reading for the oxygen sensor will be replaced by “XXX”. Replace the failed sensor as soon as possible.

If any other sensor that is installed fails, press the POWER button to acknowledge the failure and continue to Bar Hole Mode. Replace the failed sensor(s) as soon as possible for use in Normal Mode.

15. The EAGLE 3 is now operating in Bar Hole Mode. The pump is off and the following screen appears. Only the methane and oxygen channels are displayed.

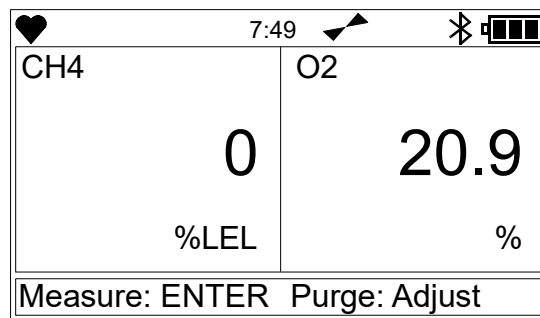

NOTE: The units for the methane channel can be changed using the RANGE ▼ SHIFT button. Press the RANGE ▼ SHIFT button until the desired units, ppm, LEL, or vol%, are displayed.

NOTE: If measuring the combustible gas in ppm units, for maximum sensor stability, allow 3-5 minutes for the sensor to warm up. The small increment size in the lower range of a ppm measurement can cause instability if the unit is not properly warmed up.

Performing a Demand Zero, Bar Hole Mode

Before using the EAGLE 3, it is recommended to set the fresh air readings for the target gases by performing a demand zero. This will set the CH₄ channel to zero and the OXY channel to 20.9%.

1. Find a fresh-air environment. This is an environment free of toxic or combustible gases and of normal oxygen content (20.9%).
2. Turn on the unit as described above in “Turning On the EAGLE 3, Bar Hole Mode” on page 248.
3. Press and hold the AIR ▲YES button. The display will indicate that a demand zero is taking place and prompt you to hold the AIR ▲YES button.
4. Continue to hold the AIR ▲YES button until the display prompts you to release it. The EAGLE 3 will set the fresh air reading for the CH₄ and oxygen channels. Start up is complete and the unit is now ready for bar hole testing.

Bar Hole Testing

In Bar Hole Mode, you can initiate sampling for a fixed time period to monitor for methane and oxygen in a bar hole. The factory set time is 30 seconds. At the end of the sample period, the pump will shut off and the peak methane and minimum oxygen levels monitored during the sample period will be displayed. Bar Hole Mode also allows you to initiate an air purge cycle to purge gas from the EAGLE 3 after a sample is taken. See pg. 163 to change the bar hole sample time.

In a low-light environment, press the **RANGE** button to turn on the display backlight. Although the backlight will turn on when any button is pressed, other buttons may initiate an undesired operation sequence. See “Selecting the Backlight Time” on page 144 to program backlight duration. If **Confirmation Alert** is turned on in the Setup Mode menu, the EAGLE 3 will alert you based on the setting you choose once every 15 minutes to confirm that it’s operating.

Performing a Bar Hole Test

1. Start up the EAGLE 3 as described on page 248.
2. Take the EAGLE 3 to the bar hole that will be tested.

3. Insert the probe into the bar hole and press the ENTER button. The pump will turn on, the display will indicate “**Measuring**” in the bottom left corner of the screen, and the sample period will begin with the sample period counting down in seconds in the lower right corner of the display. The CH₄ channel will be displayed in vol%.

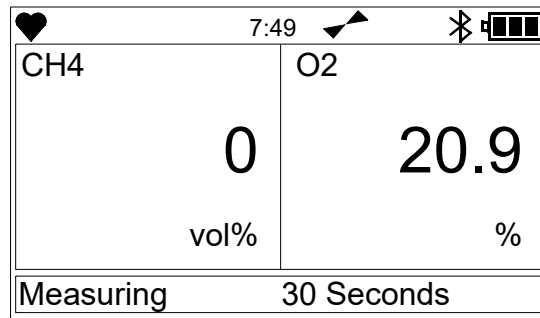

4. After 15 seconds of sampling, if the CH₄ reading is less than 5 vol%, the CH₄ channel will automatically begin displaying in the units you selected earlier. If you selected the methane channel to be displayed in vol%, then after 15 seconds, the reading will remain in vol%.
5. At the end of the sample period, the pump will shut off and the audible alarm will sound, then the peak methane reading and the minimum oxygen reading for the sample period will be displayed.
6. If a high concentration of methane is encountered, a fresh air purge can be performed to purge the hose, probe and EAGLE 3 of gas before the next bar hole test. To perform a purge, do the following:
 - Remove the probe from the barhole so the instrument will draw fresh air.
 - Press the DISPLAY button. The display will now indicate “**Fresh Air Purge**” in the bottom left corner of the screen and the purge time will begin counting down from 30 seconds in the bottom right corner of the display.

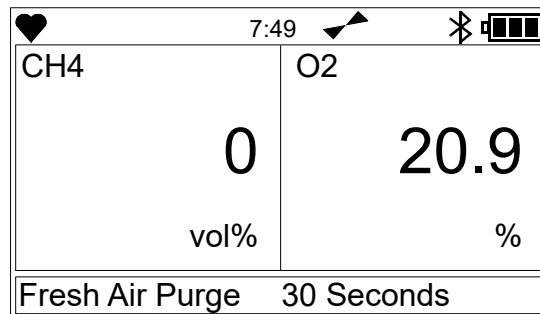

- After 15 seconds of sampling, if the CH₄ reading is less than 5 vol%, the CH₄ channel will automatically begin displaying in the units you selected earlier. Since performing a fresh air purge draws fresh air, the display units should always switch to the previously selected units. If you selected the methane channel to be displayed in vol%, then after 15 seconds, the reading will remain in vol%.
 - When the purge is complete, the screen will return to the initial Bar Hole Mode screen.
7. If other bar holes will be tested, proceed to the next bar hole and repeat Step 3 - Step 6.

8. To cancel a bar hole measurement or fresh air purge that is in progress, press the DISPLAY ADJUST NO button.
9. To exit Bar Hole Mode and return to the Mode Select Screen at any time, press and hold the RANGE ▼ SHIFT button for 5 seconds.

Turning Off the EAGLE 3, Bar Hole Mode

1. Press and hold the POWER ENTER button.
2. The unit will initiate a bar hole measurement. Keep holding the POWER ENTER button. The buzzer will sound and the LCD back light will flash for about five seconds.
3. The screen displays **Turn Off**.
4. Release the button when **Goodbye** appears on the display. When **Goodbye** disappears and the backlight turns off, the unit is off.

Appendix K: Using the EAGLE 3 in Leak Check Mode

Overview

This chapter explains how to operate the EAGLE 3 in Leak Check Mode. Leak Check Mode is used to pinpoint small leaks of combustible gas from valves, flanges, connections, and other potential leak points. When the EAGLE 3 is in Leak Check Mode, only the catalytic combustible sensor is active.

If an EAGLE 3 is intended for tracking down leaks, it is shipped with Leak Check Mode or both Leak Check Mode and Bar Hole Mode enabled so that the operator must choose which operational mode to use when the unit is turned on (see page 162).

Start Up, Leak Check Mode

This section explains how to start up the EAGLE 3 in Leak Check Mode and get it ready for operation.

Turning On the EAGLE 3, Leak Check Mode

CAUTION: *If one or more sensors other than a catalytic combustible sensor is installed, these sensors will not be active while the EAGLE 3 is in Leak Check Mode.*

The following description of the EAGLE 3 start up sequence assumes that the following menu items in Setup Mode are turned on: **Cal Reminder** and **User/Station ID**. If either of these items is turned off, then the corresponding screen will not appear.

1. Connect the standard probe to the EAGLE 3's quick connect inlet fitting.

NOTE: Use the standard probe, not the bar hole probe, when using the EAGLE 3 in Leak Check Mode.

2. If a sample hose is used, connect the sample hose to the EAGLE 3's quick connect inlet fitting and connect the probe to the sample hose's quick connect fitting.
3. Press and briefly hold down the **POWER** button. Release the button when you hear a beep.

4. The LCD displays the RKI Instruments logo for a few seconds.



5. The Date/Time screen appears for a few seconds.

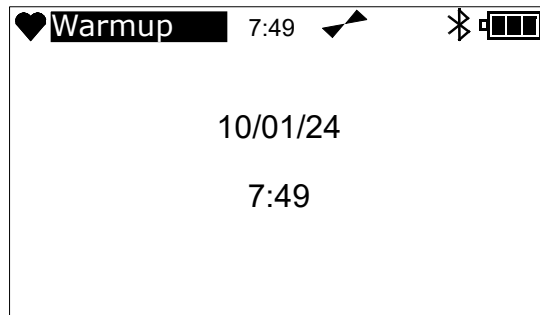

6. The Battery Voltage screen appears for a few seconds.

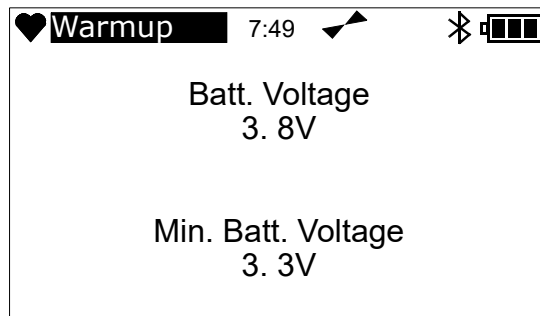

7. After the alarm screens, if **Cal Reminder** is turned on, the screen that appears next depends on how **Cal Past Due Act** is set in the Setup Mode Menu (see page 148).

- If the unit is due for calibration and **Cal Past Due Act** is set to **Confirm To Use**, then the following screen displays and the buzzer sounds in a double pulsing pattern.

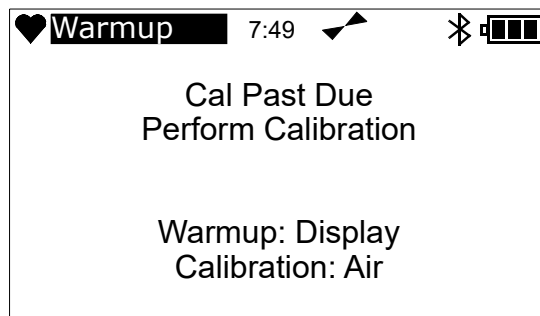

- To perform a calibration, press the AIR ▲YES button. The EAGLE 3 will enter Calibration Mode and the LCD will show the Calibration Mode main menu. See page 79 for instructions to calibrate the EAGLE 3. When you are done with the calibration and exit Calibration Mode, the unit will begin the warmup sequence. If the calibration was successful, the screen above will not appear again until the unit is due for calibration. If the calibration was not successful, the screen above will again appear in the warmup sequence.
- To continue without performing a calibration, press the DISPLAY button.
- If the unit is due for calibration and **Cal Past Due Act** is set to **Must Calibrate**, then the following screen displays and the buzzer sounds in a double pulsing pattern.

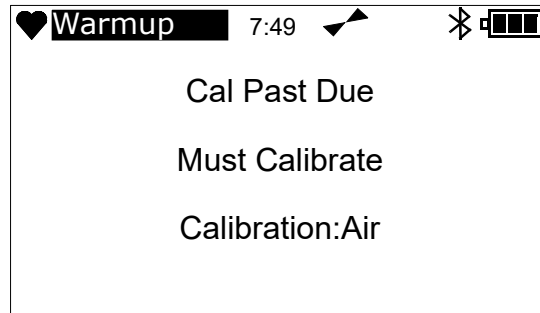

The EAGLE 3 cannot be used until a successful calibration has been performed. Press the ENTER button to enter Calibration Mode. See page 79 for instructions to calibrate the EAGLE 3.

NOTE: In this situation, even if the password function has been turned on, no password is required to perform a calibration.

When you are done with the calibration and exit Calibration Mode, the unit will begin the warmup sequence. If the calibration was successful, the screen above will not appear again until the unit is due for calibration. If the calibration was not successful, the screen above will again appear in the warmup sequence.

- If the unit is due for calibration and **Cal Past Due Act** is set to **None**, then the following alert screen displays and the buzzer sounds in a double pulsing pattern.

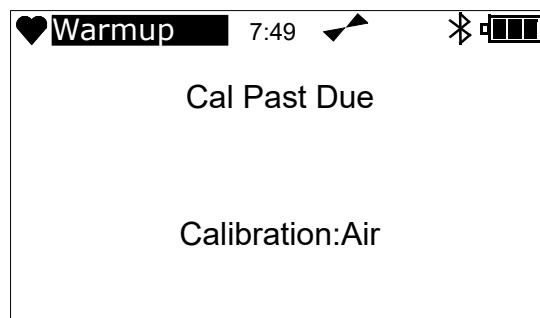

Press the POWER button to acknowledge the alert and continue with the warmup sequence.

8. The Mode Select screen displays.

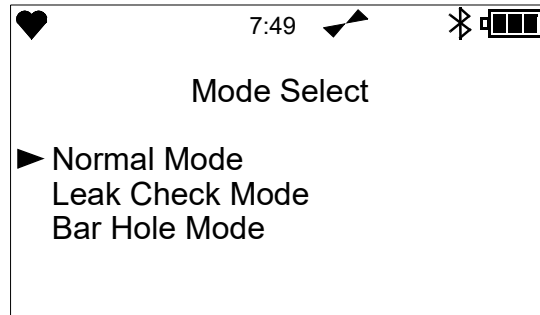

9. The cursor will flash in front of **Normal Mode**. Use the RANGE button to move the cursor next to **Leak Check Mode**.

10. With Leak Check Mode selected, press the POWER button to begin the Leak Check Mode warmup sequence.

NOTE: If no button is pressed for 20 seconds, the unit will proceed into whichever mode has the cursor in front of it.

11. The Active Gases screen appears for a few seconds indicating which channels are active and their target gas.

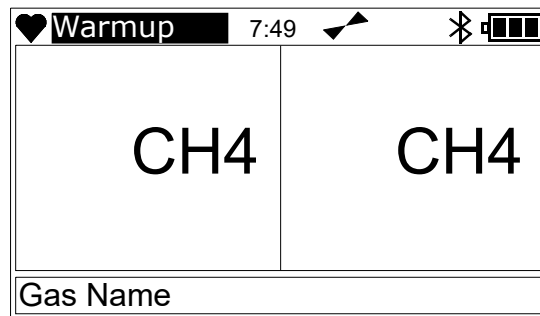

12. The instrument displays each channels' full scales and alarm setpoints in the following sequence: the full scale screen, the Alarm 1 screen, Alarm 2 screen, STEL, and TWA alarm screen. Each screen remains on the LCD for three seconds.

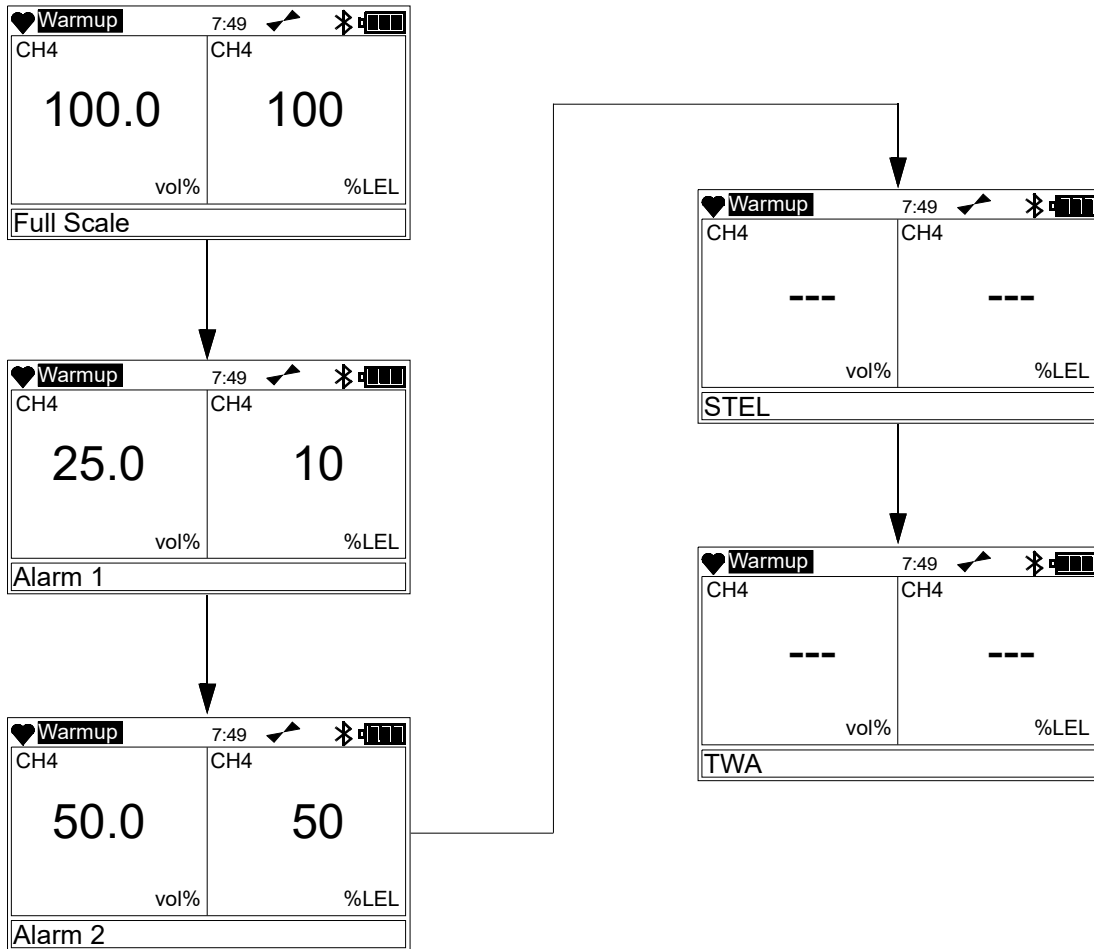

13. If **User/Station ID** is turned on (see page 138), the ID Screen appears for a few seconds.

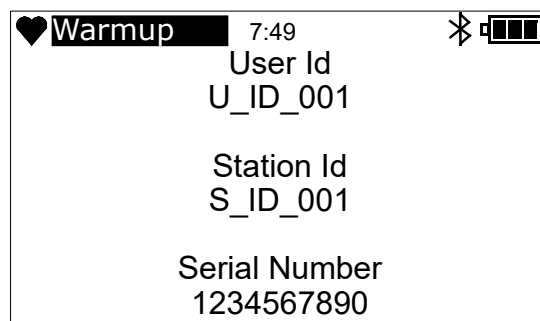

If **User/Station ID** is turned off, only the serial number is shown.

14. If the EAGLE 3 experiences a catalytic combustible sensor failure during start up, the screen indicates the sensor that failed and the buzzer sounds a pulsing tone twice per second.

In the example below, the catalytic combustible gas sensor has failed.

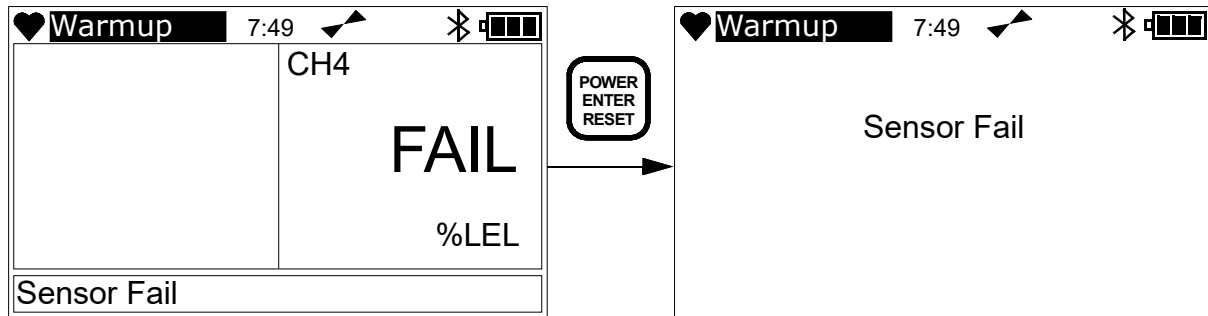

If the catalytic combustible sensor fails, it is not possible to enter Leak Check Mode. Press the POWER button to acknowledge the failure, and the instrument restarts the warmup sequence then returns to the Mode Select screen. Turn off the instrument and replace the failed sensor.

If any other sensor fails, press the POWER button to acknowledge the failure and continue to Leak Check Mode. Change the failed sensor(s) as soon as possible for use in Normal Mode.

15. The EAGLE 3 is now operating in Leak Check Mode. The pump is on and the following screen appears.

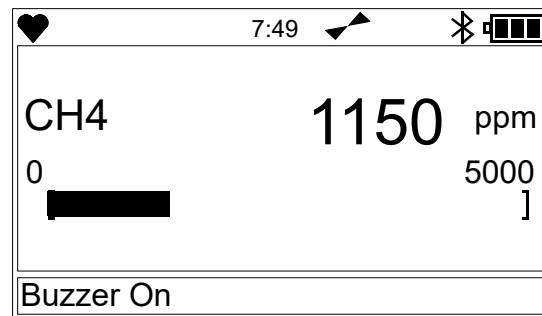

NOTE: For maximum sensor stability, allow 3-5 minutes for the sensor to warm up. The small increment size in the lower range of a ppm measurement can cause instability if the unit is not properly warmed up.

Performing a Demand Zero, Leak Check Mode

Before using the EAGLE 3, it is recommended to set the fresh air reading for the target gas by performing a demand zero. This will set the CH₄ channel to zero.

1. Find a fresh-air environment. This is an environment free of toxic or combustible gases and of normal oxygen content (20.9%).
2. Turn on the unit as described above in Turning On the EAGLE 3, Leak Check Mode.
3. Press and hold the AIR button. The display prompts you to hold the AIR button.

4. Continue to hold the AIR button until the display prompts you to release it. The EAGLE 3 will set the fresh air reading for the CH₄ channel. Start up is complete and the unit is now ready for monitoring.

Leak Testing

In Leak Check Mode, the EAGLE 3 only displays combustible gas readings. The readings are displayed in both numerical and bar graph form. The bar graph displays readings up to 5,000 ppm while the numerical indicator displays readings up to 50,000 ppm in the following increments:

- 5 ppm increments from 0 ppm to 200 ppm
- 10 ppm increments from 200 ppm to 1,000 ppm
- 50 ppm increments from 1,000 ppm to 10,000 ppm
- 250 ppm increments from 10,000 ppm to 50,000 ppm

As the gas concentration increases from 0 ppm, the alarm LEDs begin to blink in unison with the buzzer's pulsing. The blinking/pulsing rate increases as the gas reading increases. If desired the buzzer can be turned off in Leak Check Mode.

In a low-light environment, press any of the buttons to turn on the display backlight. See pg. 144 to program backlight duration. If **Confirmation Alert** is turned on in the Setup Mode menu, the EAGLE 3 beeps once every 15 minutes to confirm that it's operating.

Locating a Leak

1. Start up the EAGLE 3 as described above on page 257.
2. Move the probe tip back and forth along the area where a leak is suspected.
3. Observe the display reading. If the gas level increases, the numerical reading will increase, the bar graph level will increase to the right, and the beeping and buzzer pulsing frequency will increase.
4. Use the increasing and decreasing of the reading to locate the leak point.
5. To exit Leak Check Mode and return to the Mode Select Screen at any time, press and hold the RANGE ▼ SHIFT button for 5 seconds.

Turning the Buzzer On and Off in Leak Check Mode

The alarm buzzer can be turned off and on when the EAGLE 3 is in Leak Check Mode. This setting only applies to Leak Check Mode and does not affect buzzer operation in Normal or Bar Hole Mode. When the EAGLE 3 is turned off or you exit Leak Check Mode, it remembers the buzzer setting. So when the EAGLE 3 is turned on again or you return to Leak Check Mode after operating in Normal Mode or Bar Hole Mode, the buzzer has the same setting it did the last time it was in Leak Check Mode.

To turn the buzzer off or on while in Leak Check Mode, press the DISPLAY button.

Turning Off the EAGLE 3, Leak Check Mode

1. Press and hold the POWER button.
2. The buzzer will sound and the LCD back light will flash for about five seconds.
3. The screen displays **Turn Off**.
4. Release the button when **Goodbye** appears on the display. When **Goodbye** disappears and the backlight turns off, the unit is off.

Appendix L: Using the EAGLE 3 in Inert Mode

Inert Mode is used to measure the combustible gas and/or oxygen level in a purged environment. The oxygen alarms in this mode are both increasing and are generally set at 5.0% and 10.0%.

Description

Inert Mode is factory activated for instruments that require it. The instrument can still be used in Normal Mode for other applications.

It is recommended that either an IR CH₄ or an IR HC sensor be installed in a unit that is used to monitor combustible gas in Inert Mode since it does not require oxygen to work properly. The catalytic LEL sensor does not operate at oxygen concentrations below 10% volume. If it is necessary to use the catalytic LEL sensor in Inert Mode, a dilution fitting must be installed. Installing a dilution fitting will affect the oxygen reading since you're introducing oxygen into the sample.

Alarms

The oxygen channel alarm points in Inert Mode are different from those in Normal Mode. All other alarm point settings remain unchanged.

Since the application for Inert Mode is to detect a rising oxygen level in purged environments, both oxygen alarms are set to rising. The factory set alarm point is 5.0% volume for the low alarm and 10.0% volume for the high alarm. These alarm points are user adjustable in Setup Mode. See page 128 for instructions to set the alarm points for channels other than oxygen or to set the Normal Mode oxygen alarm points.

Below are instructions to set the Inert Mode oxygen alarms.

1. Take the EAGLE 3 to a non-hazardous location and turn it off if it is on.
2. Press and hold **AIR** and **RANGE**, then press and hold **POWER**. When you hear a beep, release both buttons.
3. The screen that appears depends on the **Setup Password** setting in Setup Mode.
If **Setup Password** is set to **On** (factory setting), continue with Step 4.
If **Setup Password** is set to **Off**, continue with Step 6.

- If **Setup Password** is set to **On**, a password screen appears. The factory-set password is **0000**, but it can be changed if desired.

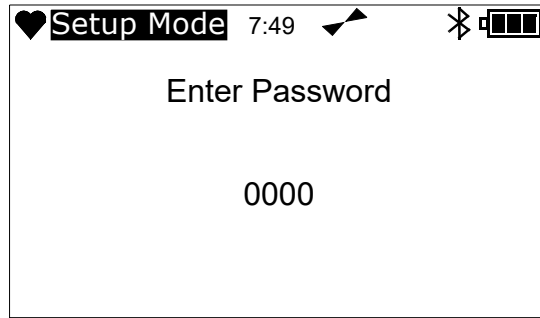

- Press **AIR** to select each password number then press **POWER** to save it and move to the next number.
To return to a previous digit, press and release **DISPLAY**.
- The Setup Mode menu appears. Press **AIR** or **RANGE** to move the cursor up or down and to view additional menu items.

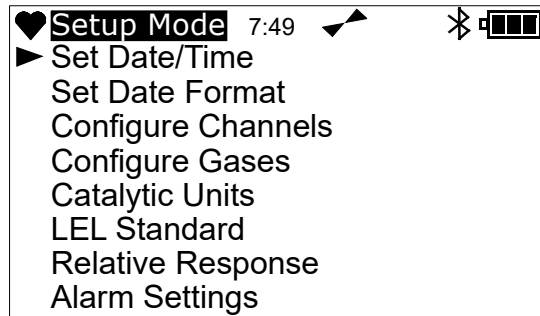

- Use the **AIR** or **RANGE** buttons to move the cursor to the **Alarm Settings** menu item.
- Press **POWER** to select the menu item. The **Alarm Points** screen appears, displaying the first channel.
- Press **AIR** or **RANGE** to scroll to the Inert screen.

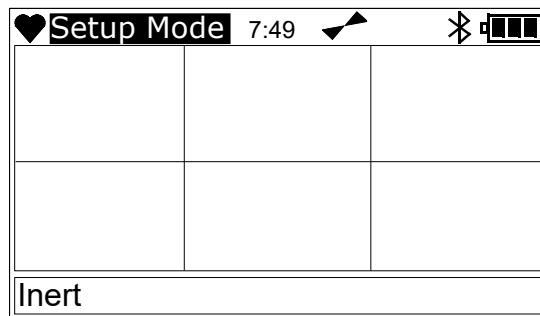

10. Press **POWER**. The Inert Mode oxygen alarm settings appear.

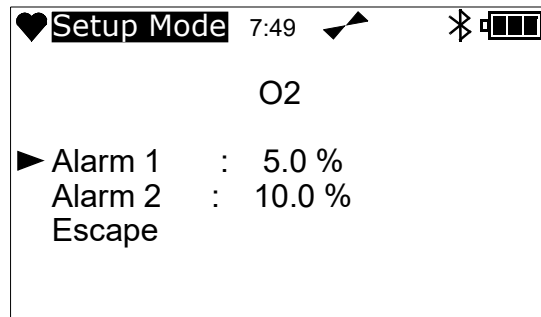

11. Press **POWER** to begin editing the **Alarm 1** setting. The setpoint will start flashing. T

12. Press **AIR** or **RANGE** to scroll to the desired value. The low alarm cannot be set higher than the high alarm, and the high alarm cannot be set lower than the low alarm.

13. Press **POWER** to confirm and repeat for the **Alarm 2** setting.

14. Press **AIR** or **RANGE** to scroll to the **Escape** menu item.

15. Press **POWER**.

16. To return to the Alarm Settings menu:

- a. Press **RANGE** until the **Escape** screen appears
- b. Press **POWER** to select the menu item.

17. To return to the Setup Mode menu:

- a. Press **AIR** or **RANGE** to scroll to the **Escape** menu item.
- b. Press **POWER** to select the menu item.

18. To exit Setup Mode:

- a. Press **AIR** or **RANGE** to scroll to **Normal Operation**.
- b. Press **POWER** to enter Normal Mode and begin the warmup sequence.

Start Up

1. Press and briefly hold down the **POWER** button. Release the button when you hear a beep.
2. The instrument will warm up as described in “Start Up” on page 30. After the bump test reminder screen, the Inert Mode Selection Screen will then be displayed.

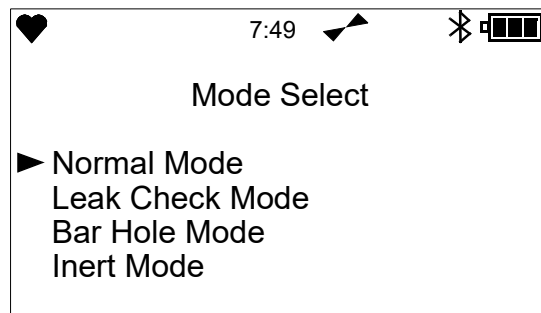

3. Press **AIR** or **RANGE** to move the cursor next to the mode you wish to enter. If you have not made a selection after 20 seconds, the instrument will warmup into the mode the cursor was next to at the end of the 20 seconds.
4. If you select **Inert Mode**, the warm up sequence will continue as described in “Start Up” on page 30. The oxygen alarms in the alarm point screens will be the alarm points for Inert Mode and not for Normal Mode.
5. When the warm up is complete and the instrument is operating in Inert Mode, the screen will appear as shown below if the instrument is sampling a fresh air environment.

♥		7:49		📶		🔊	
CH4 %LEL	O2	%	CO	ppm			
0	20.9		0				
H2S ppm							
0							
Inert							

If the instrument is sampling a fresh air environment, the oxygen channel will be in alarm.

Operation

See “Normal Mode Operation” on page 43 for operating instructions keeping in mind that the Inert Mode oxygen alarm settings are different.

You can access the Mode Selection Screen while in Inert Mode or Normal Mode by pressing and holding the **RANGE** button.

♥		7:49		📶		🔊	
Mode Select							
▶	Normal Mode						
	Leak Check Mode						
	Bar Hole Mode						
	Inert Mode						

Use the **AIR** or **RANGE** button to move the cursor next to the mode you wish to enter and press the **POWER** button.

Appendix M: EAGLE 3 Transformer Gas Tester Model

This EAGLE 3 Transformer Gas Tester Model is specially set up for electrical transformer gas testing. Large electrical transformers are filled with oil which surrounds the transformer coils, and they have an inert gas head space above the oil. When a transformer begins to fail, electrical arcing between the conductors of the coils can cause flammable gases to form in the head space. By testing the head space for these gases and recording trends of the readings, an early warning of transformer failure can be detected, and the transformer can be removed from service before it explodes.

Description

The standard setup and calibration for the catalytic combustible channel on a Transformer Gas Tester Model setup is for hydrogen with a range of 0 - 4.00% volume. When set up this way, the catalytic sensor will not respond to or will respond only slightly to the presence of methane.

The Transformer Gas Tester Model has two internal pumps installed. One pump runs at a higher voltage in order to draw sample gas from a potential vacuum into a baffle inside the instrument. The other pump pulls the sample gas from the baffle.

Since the head space being tested is filled with nitrogen, there is no oxygen in the test sample. The catalytic sensor requires oxygen in order to operate, so the instrument has an internal dilution fitting that adds air at a 1:1 ratio to the sample. This fitting is after the O₂ sensor and before the LEL sensor. Because of this internal dilution fitting, the Transformer tester version of the EAGLE 3 must be calibrated with a gas bag.

Operation

1. Turn the instrument on and allow it to warm up.
2. Press the **AIR** button in fresh air to zero the instrument.
3. Use a piece of tubing to connect the sample valve on the transformer to the barbed fitting on the front of the Eagle 3.

The sample will now be drawn into the instrument. After about 45 seconds note and record the display reading. Compare this reading to historical data to determine the condition of the transformer.

Alarms

All the gas alarms on the Transformer Gas Tester are set to OFF.

Low Flow Alarm

NOTE: Regular EAGLE 3 instruments have a low flow setpoint of 0.95 SCFH. The Transformer versions have a low flow setpoint of 1.06 SCFH.

Transformer Tester EAGLE 3 Parts List

Part Number	Description
81-1126RK	Sample bag, 9" x 9", tedlar

Appendix N: Internal Dilution Models

This appendix describes versions of the EAGLE 3 that contain an internal dilution fitting.

Description

Internal dilution versions of the EAGLE 3 have a 1:1 dilution fitting installed in the bottom case. The dilution fitting blends ambient air into the incoming sample to provide sufficient oxygen for the catalytic LEL sensor to function properly. The flow system is arranged to allow the LEL sensor to see diluted sample while all other installed sensors see normal, undiluted sample.

A vent is installed on the right side of the bottom case when viewing the instrument from the front. This equalizes the pressure inside the EAGLE 3 as the instrument draws air from inside the case through the dilution fitting's hole.

Calibration

The instrument must be calibrated with a sample bag. See “Appendix B: Calibrating with a Sample Bag” on page 188 for instructions.

Product Warranty

RKI Instruments, Inc. warrants gas alarm equipment sold by us to be free from defects in materials, workmanship, and performance for a period of one year from the date of shipment from RKI Instruments, Inc. Any parts found defective within that period will be repaired or replaced, at our option, free of charge. Parts must be returned to RKI Instruments, Inc. for repair or replacement. This warranty does not apply to those items which by their nature are subject to deterioration or consumption in normal service, and which must be cleaned, repaired or replaced on a routine basis. Examples of such items are:

- Absorbent cartridges
- Fuses
- Pump diaphragms and valves
- Batteries
- Filter elements

Warranty is voided by abuse including mechanical damage, alteration, rough handling, or repair procedures not in accordance with instruction manual. This warranty indicates the full extent of our liability, and we are not responsible for removal or replacement costs, local repair costs, transportation costs, or contingent expenses incurred without our prior approval.

THIS WARRANTY IS EXPRESSLY IN LIEU OF ANY AND ALL OTHER WARRANTIES AND REPRESENTATIONS, EXPRESSED OR IMPLIED, AND ALL OTHER OBLIGATIONS OR LIABILITIES ON THE PART OF RKI INSTRUMENTS, INC. INCLUDING BUT NOT LIMITED TO, THE WARRANTY OF MERCHANTABILITY OR FITNESS FOR A PARTICULAR PURPOSE. IN NO EVENT SHALL RKI INSTRUMENTS, INC. BE LIABLE FOR INDIRECT, INCIDENTAL, OR CONSEQUENTIAL LOSS OR DAMAGE OF ANY KIND CONNECTED WITH THE USE OF ITS PRODUCTS OR FAILURE OF ITS PRODUCTS TO FUNCTION OR OPERATE PROPERLY.

This warranty covers instruments and parts sold to users only by authorized distributors, dealers and representatives as appointed by RKI Instruments, Inc. Most Eagle 3 sensors have a 3-year warranty. Refer to the following lists of sensors that have 1 or 2-year warranties:

2-Year Warranty Sensors

- Methane (CH₄, catalytic type)
- Hydrogen (H₂, catalytic type)

1-Year Warranty Sensors

- Fluorine (F₂)
- Hydrofluoride (HF)
- Ozone (O₃)
- PID (4000 ppm and 40000 ppb ranges)
- Transformer version's Oxygen (O₂) sensor

We do not assume indemnification for any accident or damage caused by the operation of this gas monitor and our warranty is limited to the replacement of parts or our complete goods. Warranty covers parts and labor performed at RKI Instruments, Inc. only, and does not cover field labor or shipment of parts back to RKI.