



PT0E-2470

**GX-Force
Calibration Station
SDM-Force Series
Operating Manual**

RIKEN KEIKI Co., Ltd.

2-7-6 Azusawa, Itabashi-ku, Tokyo, 174-8744, Japan

Phone : +81-3-3966-1113

Fax : +81-3-3558-9110

E-mail : intdept@rikenkeiki.co.jp

Web site : <https://www.rikenkeiki.co.jp/english/>

Contents

1	Product Overview	3
1-1.	Introduction	3
1-2.	Intended use	3
1-3.	DANGER, WARNING, CAUTION, and NOTE	4
1-4.	Checking CE marking models	4
2	Important Safety Information	5
2-1.	Danger information	5
2-2.	Warning information	5
2-3.	Precautions	5
2-4.	Handling the gas	6
3	Product Configuration	7
3-1.	Main unit and accessories	7
	Main unit	7
	Accessories	7
3-2.	Part names and functions	8
4	Usage Instructions	10
4-1.	Usage note	10
4-2.	Startup preparations	10
4-2-1.	Required equipment/materials	10
4-2-2.	Interconnection (optional)	13
4-2-3.	Attaching the wall mounting fixture (sold separately)	15
4-2-4.	Connecting the AC adapter	17
4-2-5.	Attaching the cylindrical filter (dust filter)	18
4-2-6.	Mounting the gas detector (sold separately)	19
4-2-7.	Connecting the gas	22
4-2-8.	Installing the PC Controller Program (sold separately)	26
4-3.	Startup	30
4-3-1.	Turning on the power	30
4-3-2.	LCD screen display	32
4-3-3.	LED display list	34
4-4.	Settings	36
4-4-1.	Setting list	40
4-4-2.	Cylinder settings	43
4-5.	Operations using the product operation buttons	47
4-5-1.	Bump test and gas adjustment procedure	47
4-5-2.	Copying test/adjustment results to a USB flash drive (sold separately)	52
4-5-3.	Downloading gas detector (sold separately) logger data	55
4-5-4.	Updating firmware	58
4-6.	Operations using the PC Controller Program (sold separately)	61
4-6-1.	Bump test and gas adjustment procedure	61
4-6-2.	Creating a calibration certificate	70
4-7.	Turning off the power	72
5	Maintenance	73
5-1.	Maintenance intervals and maintenance items	73
	Maintenance service	73
5-2.	Cleaning instructions	74
5-3.	Parts replacement	74
5-3-1.	Periodic replacement parts	74
5-3-2.	Replacing the cylindrical filter (dust filter)	75
5-4.	Portable gas detector maintenance	75
6	Storage and Disposal	76
6-1.	Procedures for storage or when not in use for extended periods	76
6-2.	Product disposal	76
6-3.	Disposing of gas cylinders (sold separately)	76
7	Troubleshooting	77
8	Product Specifications	80
8-1.	Specifications list	80
8-2.	Accessory list	81

Product Overview

1-1. Introduction

Thank you for your purchase of the SDM-Force Series Bump Tester for the GX-Force Portable Gas Detector (“the product” hereinafter). Please confirm that the model number of the product you purchased matches the model number of the product covered by this manual.

The product should be used only by fully-trained personnel.

The maintenance procedures described in this manual also should be performed only by appropriately-trained personnel. Any maintenance procedure not described in this manual must be performed by RIKEN KEIKI or our certified service engineers. Please contact RIKEN KEIKI.

This manual describes how to use the product and provides product specifications. Make sure you have read and fully understood the contents of this manual before using the product. This applies both to first-time users and those who have previously used the product. Keep this manual in a handy place so that you can refer to it at any time.

The contents of this manual are subject to change without notice to allow product improvements. Any duplication or reproduction of this manual without permission is prohibited, whether in whole or in part.

In addition to this manual, manuals are provided for optional products. Refer to the following manuals along with this manual when using optional products:

GX-Force Portable Gas Detector Operating Manual (PT0E-210)

Regardless of the warranty period, RIKEN KEIKI does not accept any liability for accidents or damage resulting from use of the product. Be sure to read the warranty policy set forth on the warranty.

1-2. Intended use

The product is a dedicated bump tester designed for use with the GX-Force Portable Gas Detector (sold separately). It allows charging, bump tests, gas adjustment, and alarm checks for the GX-Force.



The product can be operated either using the buttons on the unit, or by connecting to a computer (PC) using the dedicated SW-SDM-PC3(EX) PC Controller Program (sold separately).

The number of solenoid valves (one to three, specified at the time of purchase) and the number of gas types that can be connected simultaneously depend on the product specifications. Check the specifications before use to ensure correct use for the intended purpose.

Note that this document refers to the GX-Force Portable Gas Detector (sold separately) simply as “gas detector (sold separately)”.

1-3. DANGER, WARNING, CAUTION, and NOTE

This manual uses the following headings to ensure safe and effective work:

 DANGER	This indicates situations in which improper handling may result in fatal or serious injury to persons or serious damage to property.
 WARNING	This indicates situations in which improper handling may result in serious injury to persons or serious damage to property.
 CAUTION	This indicates situations in which improper handling may result in minor injury to persons or minor damage to property.
NOTE	This indicates handling tips.

1-4. Checking CE marking models

CE marking compliant models feature a CE marking. Check actual product specifications before use. For CE marking models, refer to the 'Declaration of Conformity' provided at the end of this manual.

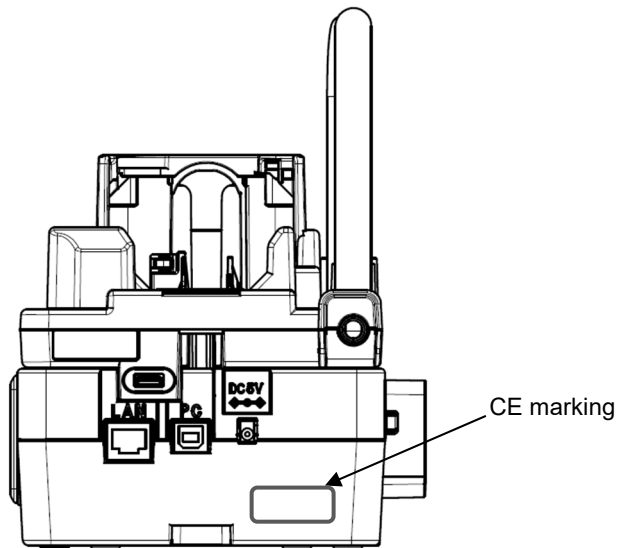

CE marking location

Important Safety Information

2-1. Danger information



DANGER

Usage

- The product is a non-explosion-proof device. Never use it in hazardous areas.
- Do not attempt to disassemble or modify the product.

2-2. Warning information



WARNING

Usage

Power source

- Before turning on the power for the product, be sure to confirm that the power source meets the specified voltage requirements.
Avoid using unstable power sources; doing so may lead to malfunctions.

External connections

- Avoid applying excessive pressure to the gas and air inlets.
Applying excessive pressure to the product's sampling pipe openings (GAS IN, GAS OUT) is hazardous. Doing so may cause the detection target gas to leak from the product.
- Discharge the gas exhausted after use to a location determined to be safe by connecting an exhaust pipe to the detection target gas outlet (GAS OUT) located on the bottom of the main unit.

Sensor handling

Zero adjustment in surrounding atmosphere (fresh air adjustment)

- Before using the product, confirm that the surrounding atmosphere is filled with fresh air.
Correct adjustment will not be possible in the presence of miscellaneous gases. The presence of interference gases is also extremely dangerous because the product may not detect actual gas leaks correctly.

2-3. Precautions



CAUTION

Usage

Product installation

- Install the product on a flat work table.

External connections

- Be careful not to damage the USB flash drive storing test results and maintenance history due to contact.

2-4. Handling the gas



CAUTION

Handling gas containers (gas cylinders and calibration gas cans)

- Do not subject containers to impact.
- Do not expose to direct sunlight or high temperatures.
- Take precautions to keep containers from toppling and to prevent other accidents.
- Be sure to remove the gas cylinders and calibration gas cans when transporting the product. There is a risk of gas leakage if they are damaged due to contact during transportation.
- Store in a dedicated storage area well-ventilated by ventilation fans or other means.
- Gas containers cannot be refilled. Use until no pressure remains.
- Dispose of gas containers in accordance with procedures specified by local authorities.

Handling the gas

- Check to confirm that there are no devices in the vicinity that may be affected by the gas, and ventilate the area.

Product Configuration

3-1. Main unit and accessories

Open the box and packaging and inspect the product and accessories.
If anything is missing, contact RIKEN KEIKI.

Main unit

For detailed information on the names and functions of product parts and the LED display, refer to '3-2. Part names and functions.'

The product consists of the SDM-Force(U) on which the gas detector (sold separately) is mounted and the SDM-BASE to which the gas is connected.

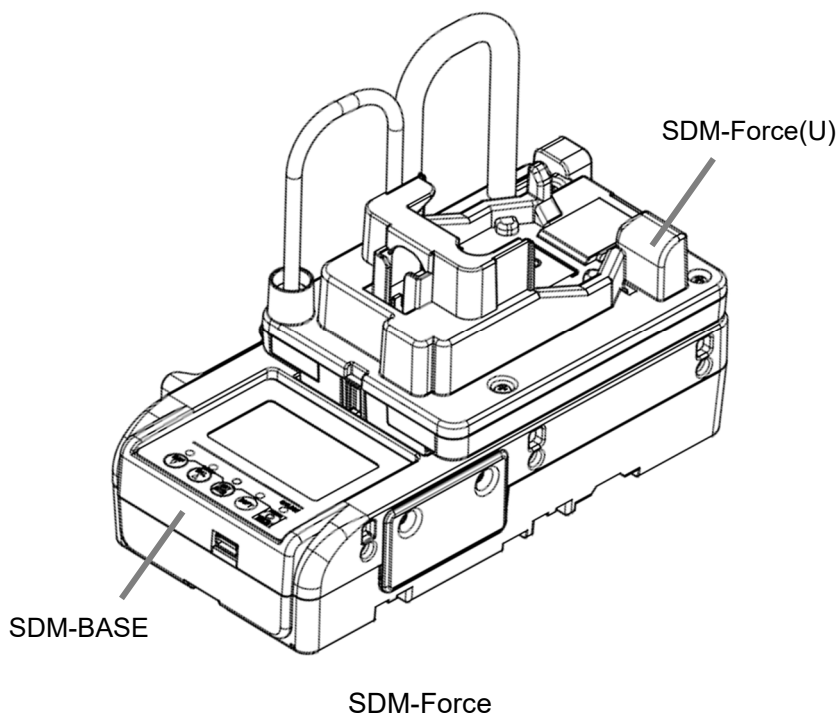

Accessories

- Cylindrical filter (×1)
- Tube (approx. 40 mm long, 5 to 7 mm diameter) (×1)
- AC adapter (×1)
- Connecting fixture (set of 2)
- USB cable (×1)

3-2. Part names and functions

This section describes the names and functions of the various parts of the main unit.

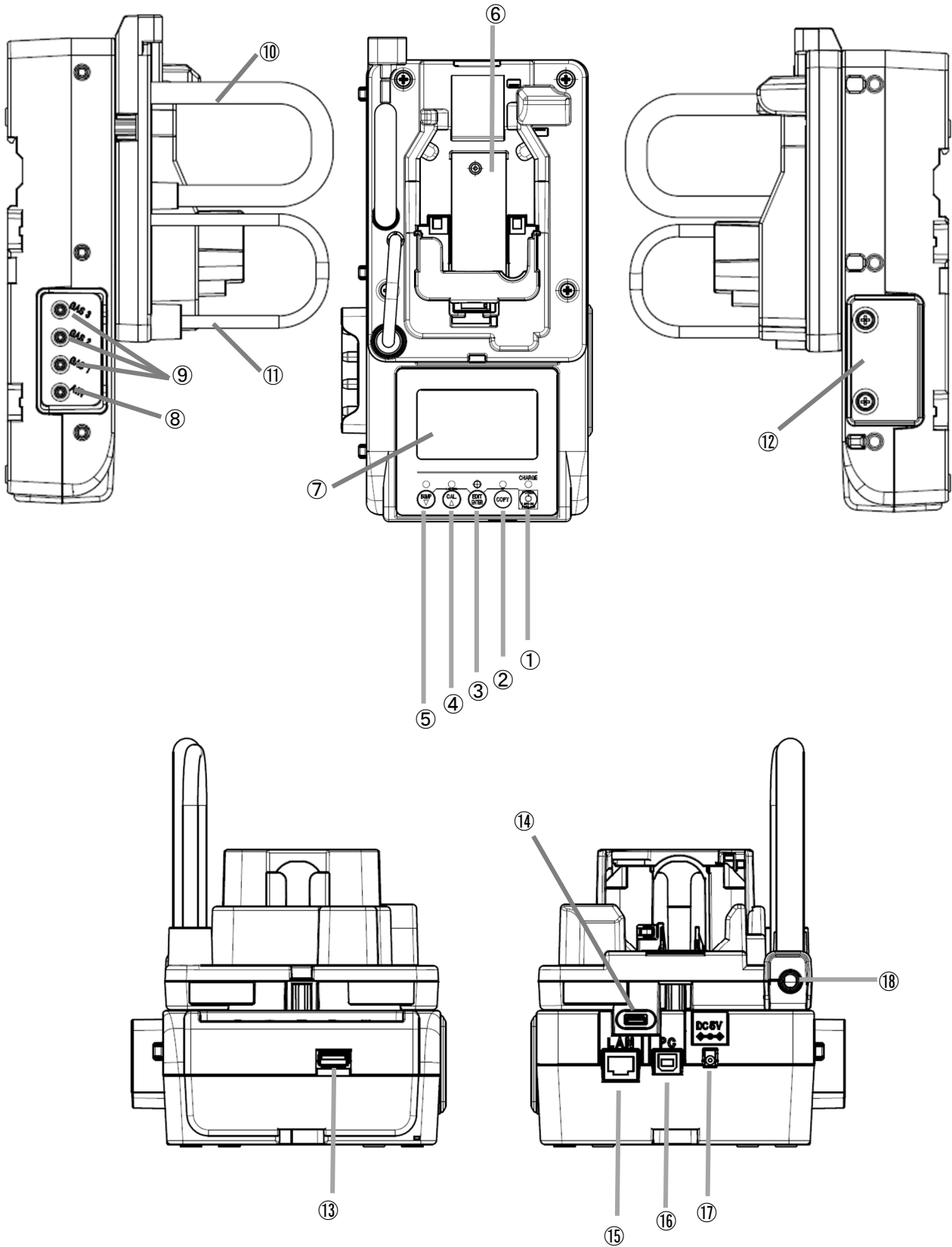

No.	Name	Function
①	POWER button	<ul style="list-style-type: none"> Turns the product power on and off. (Pressing this button and the EDIT/ENTER button simultaneously turns off the gas detector (sold separately).)
②	COPY button	<ul style="list-style-type: none"> Copies bump test, gas adjustment, and alarm check records to a USB flash drive (sold separately). (Pressing this button and the CAL/▲ button simultaneously clears the product memory.)
③	EDIT/ENTER button	<ul style="list-style-type: none"> Displays various setting menus. (Pressing this button and the BUMP/▼ button simultaneously starts the alarm check.) (Pressing this button and the POWER button simultaneously turns off the gas detector (sold separately).)
④	CAL/▲ button	<ul style="list-style-type: none"> Starts/cancels gas adjustment. Moves the cursor up on the screen. (Pressing this button and the COPY button simultaneously clears the product memory.)
⑤	BUMP/▼ button	<ul style="list-style-type: none"> Starts/cancels the bump test. Moves the cursor down on the screen. (Pressing this button and the EDIT/ENTER button simultaneously starts/cancels the alarm check.)
⑥	Gas detector dock	Position for mounting the gas detector (sold separately) on the product
⑦	LCD display	Displays the status and settings.
⑧	Air inlet	Aspirates air.
⑨	Gas inlets	Draw in gas. Marked GAS 3/GAS 2/GAS 1 from left to right
⑩	GAS OUT tube	Tube for connecting to GAS OUT on the gas detector (sold separately)
⑪	GAS IN tube	Tube for connecting to GAS IN on the gas detector (sold separately)
⑫	Side cover	Remove when multiple units of the product are interconnected (optional).
⑬	USB port	Used to save text files to a USB flash drive (sold separately)
⑭	Gas detector connection cable connector	You can connect the product to a gas detector using a USB cable (Type-C male - Type-C male) (sold separately).
⑮	LAN cable connector	You can connect the product to a network within the building using a LAN cable (sold separately). Use a separately sold or shielded LAN cable to prevent malfunctions due to noise.
⑯	PC connection cable connector	You can connect the product to a PC using a USB cable (Type-A male - Type-B male) (sold separately).
⑰	Power jack	Insert the power supply AC adapter plug.
⑱	Gas outlet	Discharges drawn gas.

Usage Instructions

4-1. Usage note

The operating precautions apply to both first-time users and those who have previously used the product. Ignoring these precautions may damage the product and result in inaccurate gas detection.



DANGER

Usage

- The product is a non-explosion-proof device. Never use it in hazardous areas.
- Do not attempt to disassemble or modify the product.



WARNING

Usage

Before turning on the power for the product, be sure to confirm that the power source meets the specified voltage requirements. Avoid using unstable power supplies; doing so may lead to malfunctions.

4-2. Startup preparations

NOTE

- The product is compatible with the GX-Force Portable Gas Detector (sold separately).

4-2-1. Required equipment/materials

The following equipment and materials are required in addition to the product.

- GX-Force Portable Gas Detector
- Calibration gas for bump test/gas adjustment
- Gas sampling bag for exhaust gas (where necessary)
- Exhaust tube (where necessary)

<When using a gas mixture cylinder>

- Demand flow valve
- Tube (no longer than 1 m; recommended internal diameter: 5 mm)

<When collecting gas in a gas sampling bag>

- Gas sampling bag

<Recommended calibration gas concentrations for bump test/gas adjustment>

Detection target gas	Sensor model	Gas	Gas concentration
Combustible gas (HC)	NCR-6309	Isobutane (i-C ₄ H ₁₀)	50 %LEL (0.9 %)
Combustible gas (CH ₄)	NCR-6309	Methane (CH ₄)	50 %LEL (2.5 %)
Oxygen (O ₂)	ESR-X13P	Oxygen (O ₂) N ₂ diluted	12.0 vol%
Carbon monoxide (CO)	ESR-A1DP	Carbon monoxide (CO)	50 ppm
Hydrogen sulfide (H ₂ S)	ESR-A1DP	Hydrogen sulfide (H ₂ S)	25.0 ppm
Hydrogen sulfide (H ₂ S)	ESR-A13i	Hydrogen sulfide (H ₂ S)	25.0 ppm
Carbon monoxide (CO)	ESR-A1CP	Carbon monoxide (CO)	50 ppm
Carbon monoxide (CO)	ESR-A1CP	Hydrogen (H ₂) Air diluted	500 ppm



WARNING

Calibration gas for bump test/gas adjustment

The calibration gas for bump test/gas adjustment may be hazardous (combustible or toxic gas) or may cause oxygen deficiency. Handle the gas and related jigs and tools with due care.

Gas sampling bag

Use different gas sampling bags for each gas type and concentration to ensure accurate adjustment.

Gas introduction

Connecting a high-pressure gas cylinder directly may damage the product or the pump in the gas detector (sold separately) mounted on the product. Use a gas sampling bag or other method to avoid introducing high-pressure gas.

Bump test and gas adjustment location

- Do not perform bump tests or gas adjustment in confined spaces.
- Do not perform bump tests or gas adjustment in an atmosphere where silicone or organic solvents are present.
- Perform adjustment indoors at normal temperatures with no significant fluctuations (within ± 5 °C).

Zero adjustment in surrounding atmosphere (fresh air adjustment)

- Before using the product, confirm that the surrounding atmosphere is filled with fresh air.
- Correct adjustment will not be possible in the presence of miscellaneous gases. The presence of interference gases is also dangerous because actual gas leaks may not be detected correctly.



CAUTION

Gas discharge

- When feeding gas, it should either be discharged to a safe location with the gas outlet open to the atmosphere or collected using a gas sampling bag.
- When using the product with multiple units interconnected, discharge exhaust gas from each unit separately.

Demand flow valve

- Demand flow valves have a limit on the maximum flow rate they can draw in. When using a demand flow valve, the product should not be used with multiple units interconnected.
- Check the specifications of the demand flow valve to confirm its maximum flow rate.

When using the product with multiple units interconnected

- When gas is introduced for the first time to the product, particularly when the units are interconnected, it may take some time for the air in the piping to be replaced by the gas. If a bump test results in FAIL, execute the bump test again and check.

4-2-2 Interconnection (optional)

The product can be used with the units interconnected. The number of units that can be interconnected is as follows.

- When gas is supplied using gas bags: Up to 10 units
- When gas is supplied using demand flow valve: Up to 5 units



CAUTION

Do not connect more units than listed above together. It may result in inadequate flow rates due to piping resistance.

NOTE

- Only the piping is connected; the units are not connected electrically.

- 1 Confirm that the product is not connected to the power supply.**
- 2 Follow steps 3 to 5 below for all SDM-Force units except for the rightmost unit.**

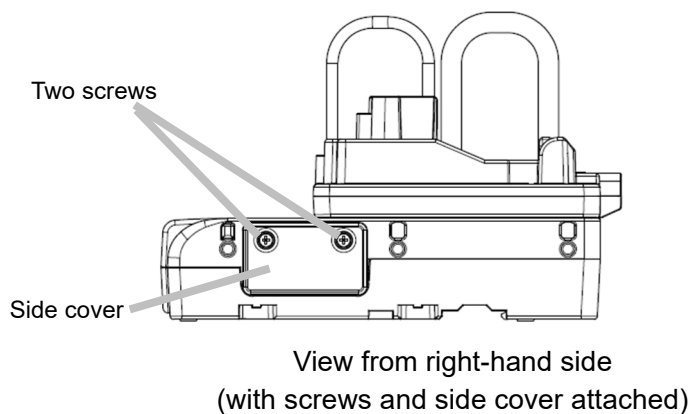

- 3 Remove the two screws securing the side cover on the right-hand side of the product.**

Keep the screws, taking care not to lose them.

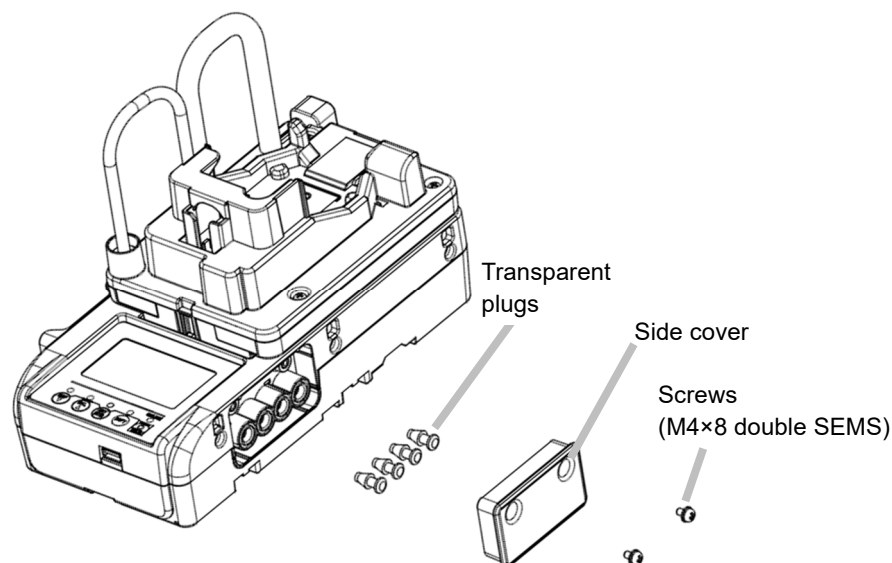

4 Remove the side cover.

Keep the side cover, taking care not to lose it.

5 Remove the transparent plugs attached to the four sample connectors.

Keep the plugs, taking care not to lose them.

6 Align the sample connectors on the two leftmost product units, then push in until the two product units are in contact with each other.

7 Add a product unit in the same way as in step 6.

Leave the right-hand panel attached to the last product unit connected.

8 Add the connecting fixtures and screws (sold separately), then secure the two product units together at the two connecting points on the base of each unit.

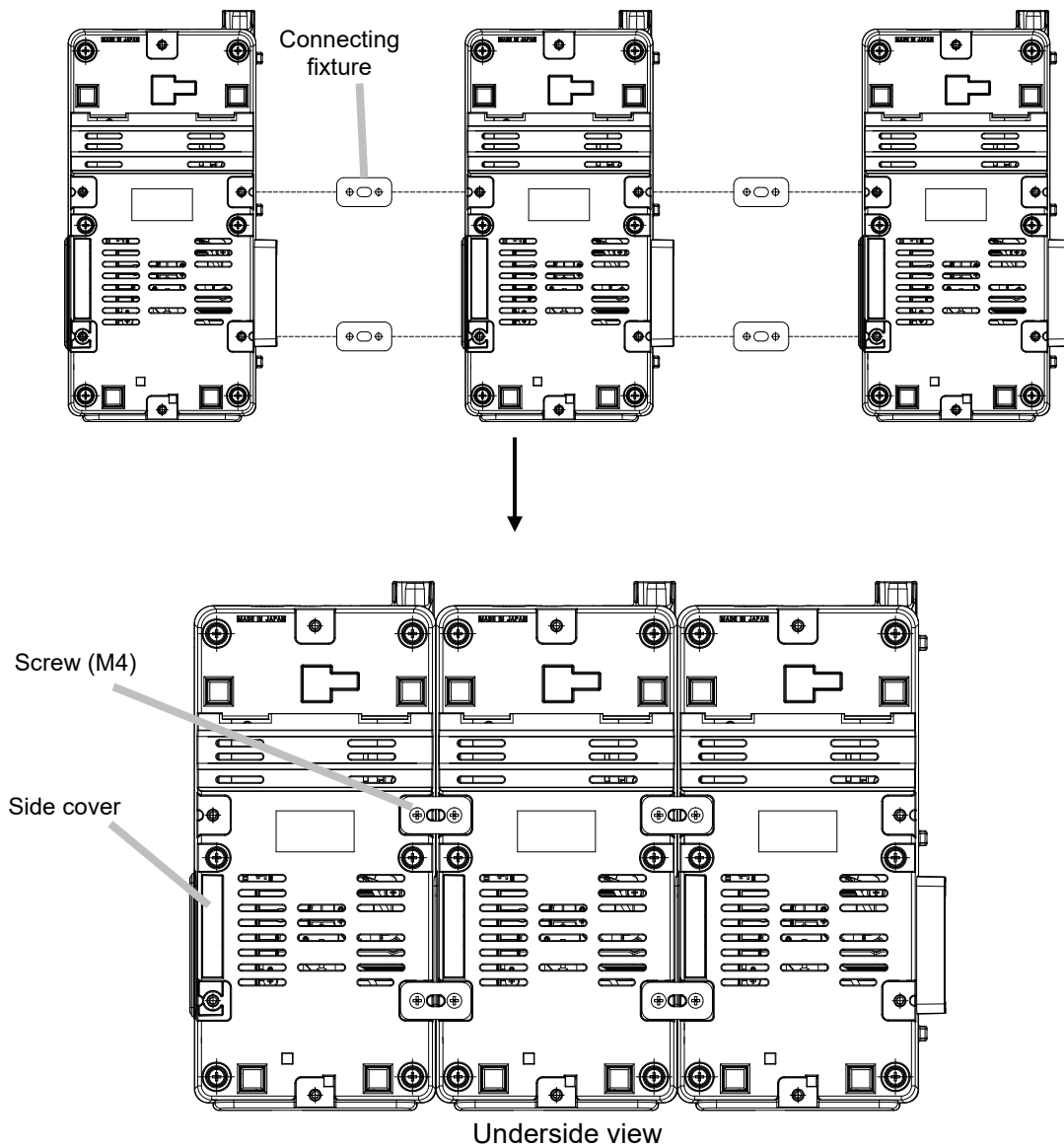

4-2-3. Attaching the wall mounting fixture (sold separately)

- 1 Use the screws provided (M4×8) to secure the wall mounting fixture (sold separately) to the product.

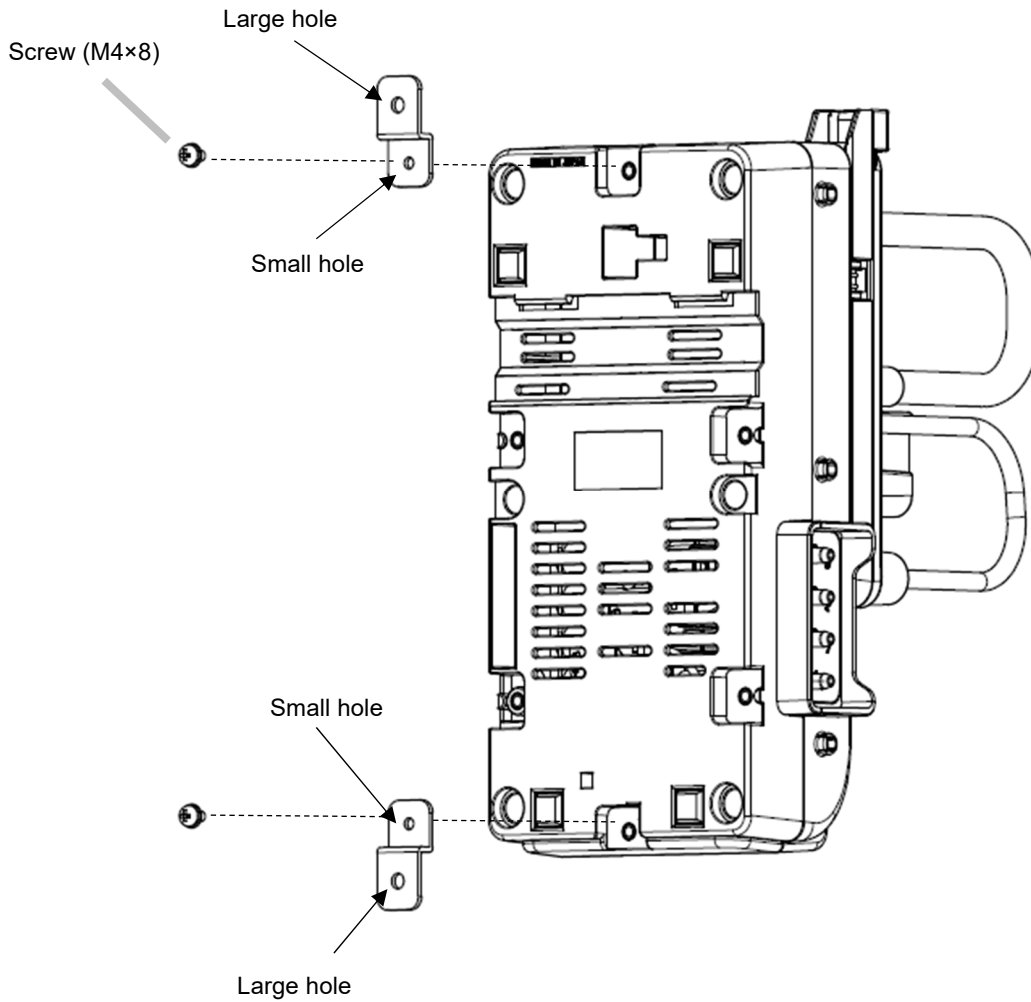

2 Use the screws to secure the wall mounting fixture to the wall.

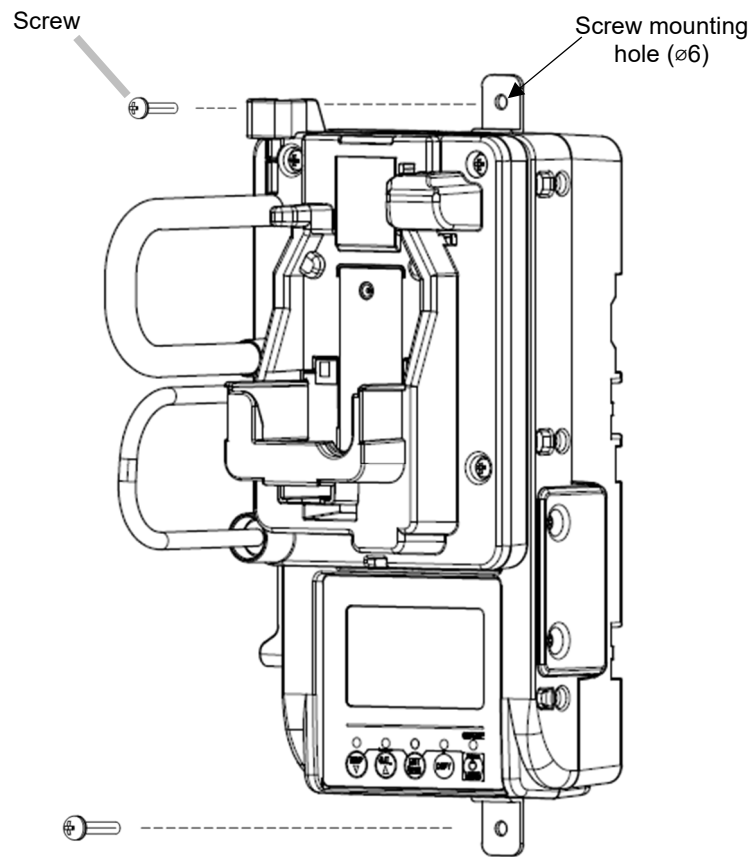

4-2-4. Connecting the AC adapter

- 1 **Insert the plug of the AC adapter into the power jack at the rear of the product.**

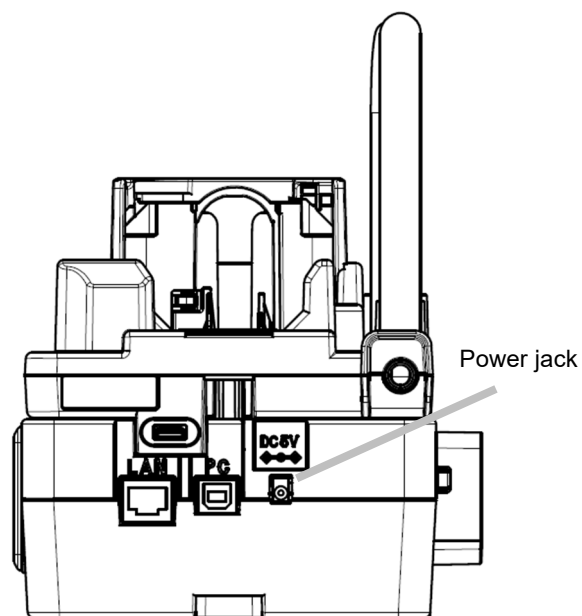

- 2 **Plug the AC adapter into the mains outlet.**

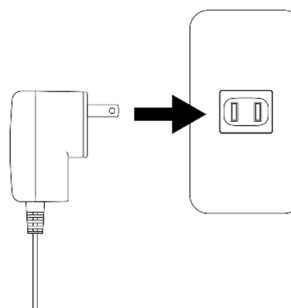

NOTE

- When using the product with multiple units interconnected, each unit must be connected to a separate power supply.

4-2-5. Attaching the cylindrical filter (dust filter)

- 1 Attach the cylindrical filter provided, aligning the direction of the arrow engraved on it with the AIR inlet on the side of the product.**

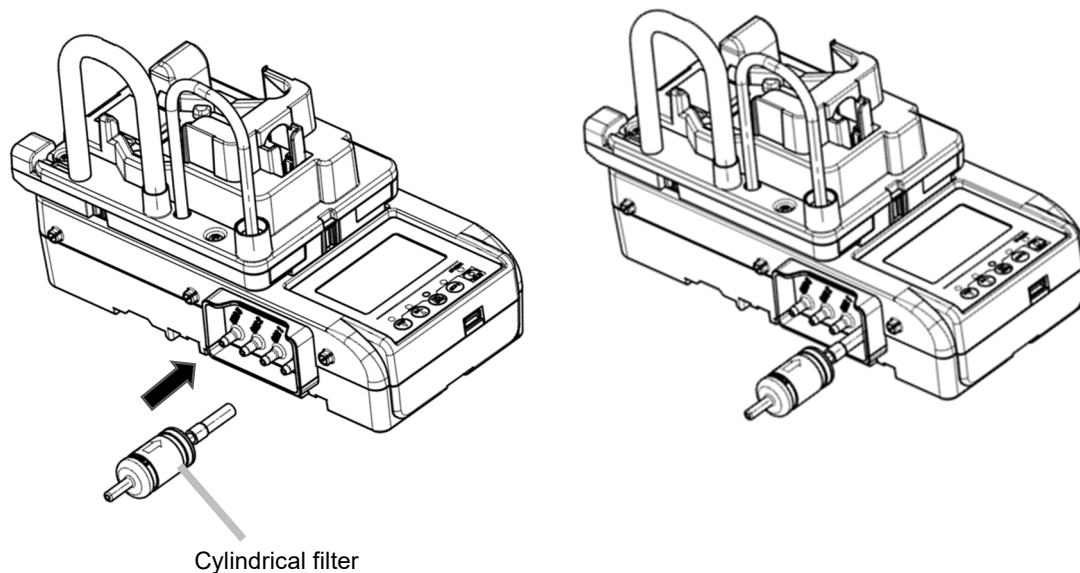

4-2-6. Mounting the gas detector (sold separately)



CAUTION

Before mounting the gas detector (sold separately), wipe off any dirt or water droplets from the gas detector, as dirt or droplets may result in clogging of the product piping.

- 1 Mount the gas detector (sold separately) with the LCD display facing the product.**

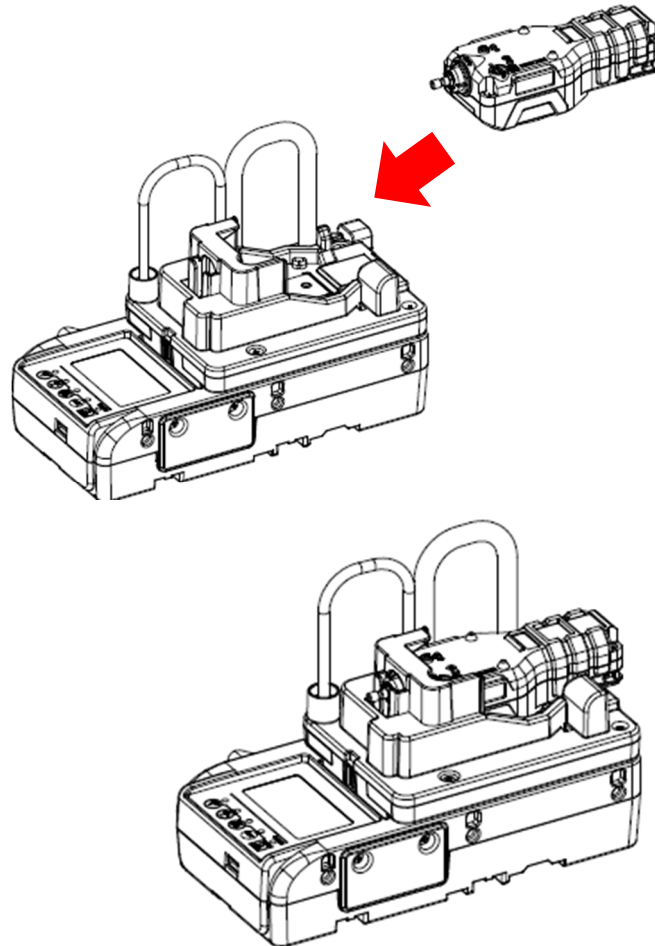

CAUTION

It may not be possible to connect the gas detector (sold separately) to the product if it is incorrectly mounted as shown in Figure 1. Mount the gas detector (sold separately) correctly by pressing it securely to the rear of the product as shown in Figure 2.

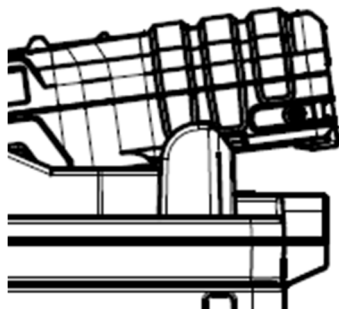

Figure 1. Incorrectly mounted (example)

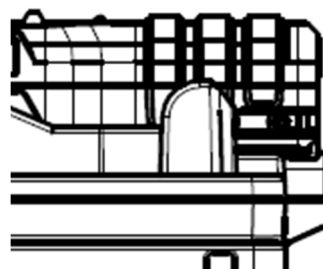
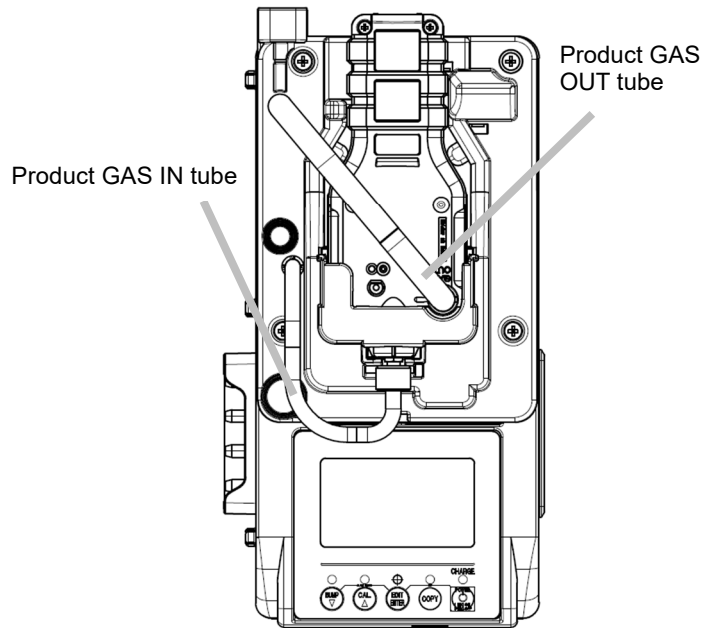
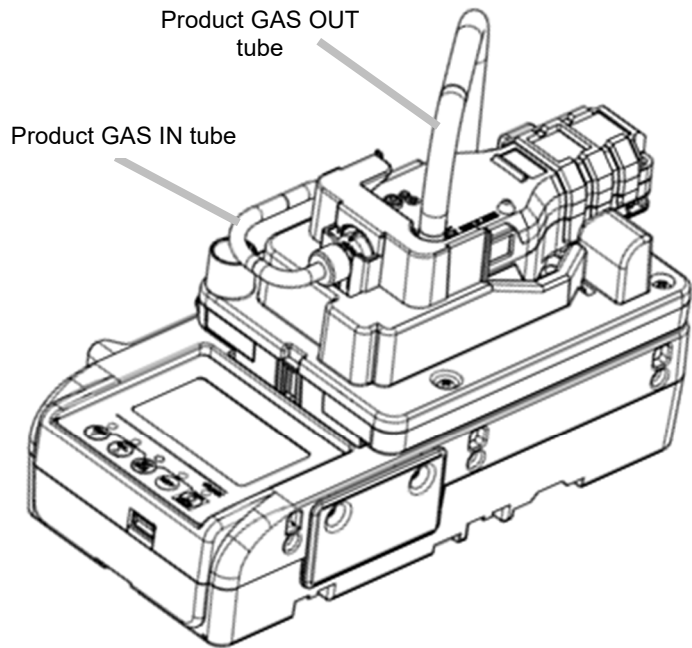

Figure 2. Correctly mounted

2 Connect the GAS IN/OUT tubes on the product to the gas detector (sold separately).

Connect the GAS IN tube on the product to the gas inlet on the gas detector (sold separately), then connect the GAS OUT tube to the gas outlet on the gas detector (sold separately).



CAUTION

- After mounting the gas detector (sold separately), check to confirm that the GAS IN and OUT tubes on the product are not kinked.

- 3 Connect the gas detector (sold separately) to the product using a USB cable (Type-C male - Type-C male) (sold separately).**

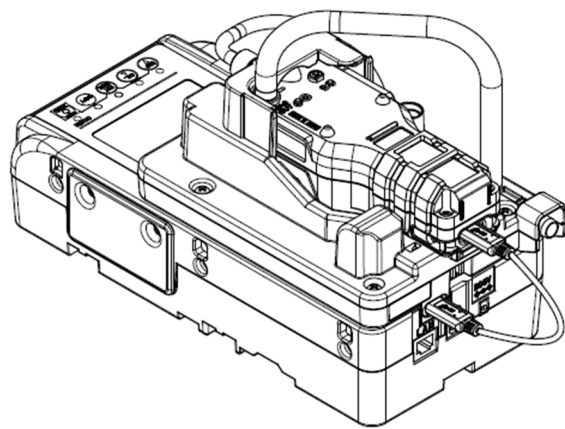
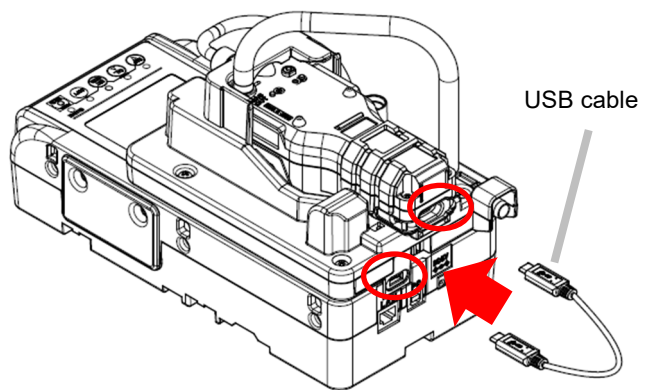

4-2-7. Connecting the gas

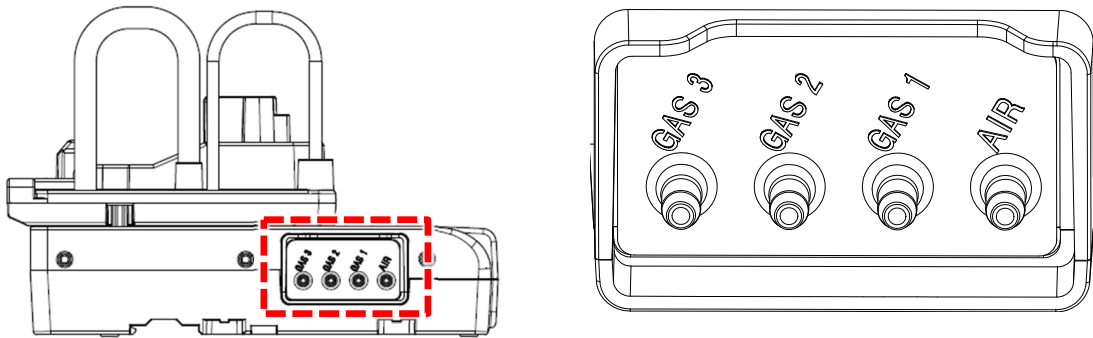

The gas inlets are located on the side of the product.

On products containing one solenoid valve, the gas inlet is GAS 1.

On products containing two solenoid valves, the gas inlets are GAS 1 and GAS 2.

On products containing three solenoid valves, the gas inlets are GAS 1, GAS 2, and GAS 3.

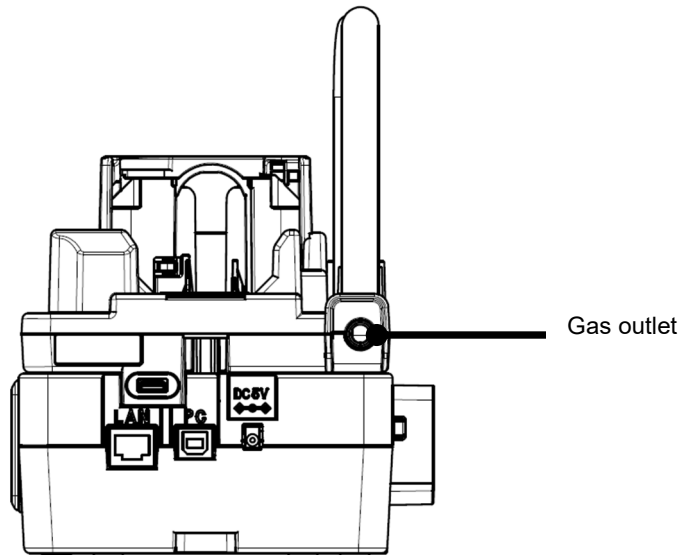

Connectors are located at the rear of the product for connecting to external devices.



WARNING

Calibration gas for bump test/gas adjustment

- The calibration gas for bump test/gas adjustment may be hazardous (combustible or toxic gas) or may cause oxygen deficiency. Handle the gas and related jigs and tools with due care.

Gas sampling bag

- Use different gas sampling bags for each gas type and concentration to ensure accurate adjustment.

Gas introduction

- Connecting a high-pressure gas cylinder directly may damage the product pump. Use a gas sampling bag or other method to avoid connecting high-pressure gas.

Bump test and gas adjustment location

- Do not perform bump tests or gas adjustment in confined spaces.
- Do not perform bump tests or gas adjustment in an atmosphere where silicone or organic solvents are present.
- Perform adjustment indoors at normal temperatures with no significant fluctuations (within ± 5 °C).

Gas discharge when multiple units are interconnected

- When using the product with multiple units interconnected, discharge exhaust gas from each unit separately.
- Do not combine the exhaust tubes into a single tube for gas discharge.



CAUTION

- When feeding gas, it should either be discharged to a safe location with the gas outlet open to the atmosphere or collected using a gas sampling bag.

<Piping>

NOTE

- Set what gas to connect to what gas inlet before using the product. (Refer to '4-4-2. Cylinder settings'.)
- If the number of gas types to be connected exceeds the number of solenoid valves on the product, the next gas must be connected manually after introducing the first gas.

With three solenoid valves

Gas can be introduced via each of three gas inlets GAS 1 to GAS 3.

Set what gas type to be introduced via what gas inlet as described later in '4-4-2. Cylinder settings'.

If there are insufficient gas inlets for the number of gas types to be introduced, you can manually switch gas types on the GAS 2 or GAS 3 inlet.

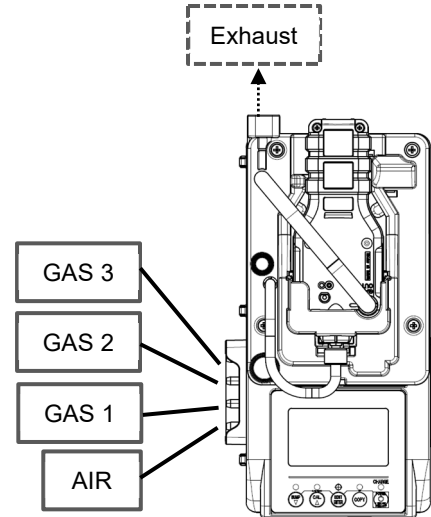

With one solenoid valve

Gas can be introduced via the GAS 1 inlet only.

This is suitable for situations in which only one gas type or gas mixture is used.

When introducing multiple types of gas into the product by individual gas type, you can switch to a different gas on GAS 1 each time a bump test or gas adjustment for a gas type is completed.

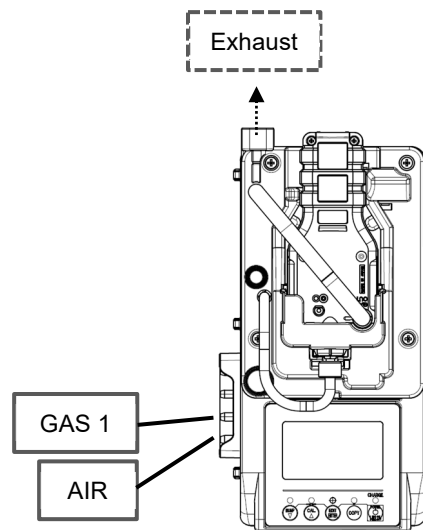

With two solenoid valves

On products containing two solenoid valves, gas can be introduced via the GAS 1 and GAS 2 inlets.

If there are insufficient gas inlets for the number of gas types to be introduced, you can switch to a different gas on GAS 2 after a bump test or gas adjustment is completed on GAS 1 and GAS 2.

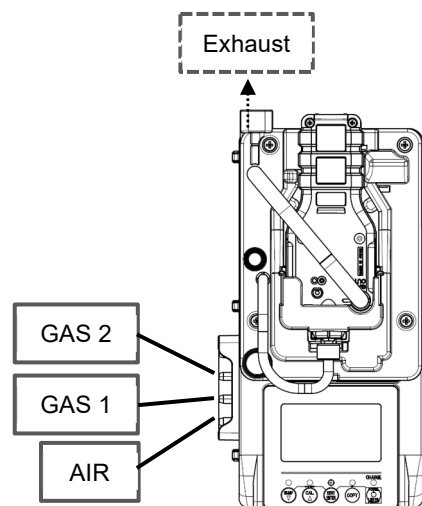

<Piping (using the PC Controller Program (sold separately))>

NOTE

- When using the PC Controller Program (sold separately), you must set what gas type to be introduced via what gas inlet.
- Mount the gas detector (sold separately) on the product before connecting the PC.

SDM-Force(C3): With three solenoid valves

Gas can be introduced via each of three gas inlets GAS 1 to GAS 3.

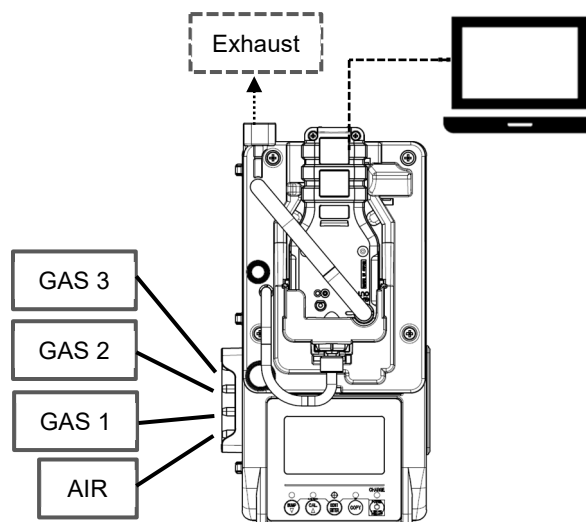

SDM-Force(C1): With one solenoid valve

Gas can be introduced via the GAS 1 inlet only, in the same way as the piping arrangement when no PC is used.

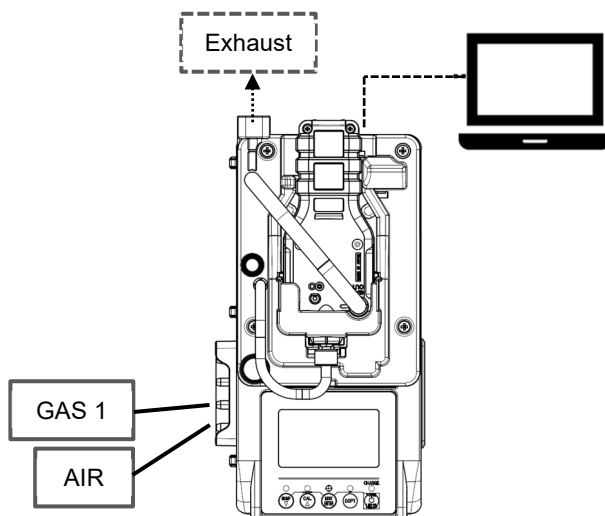

SDM-Force(C2): With two solenoid valves

Gas can be introduced via the GAS 1 and GAS 2 inlets.

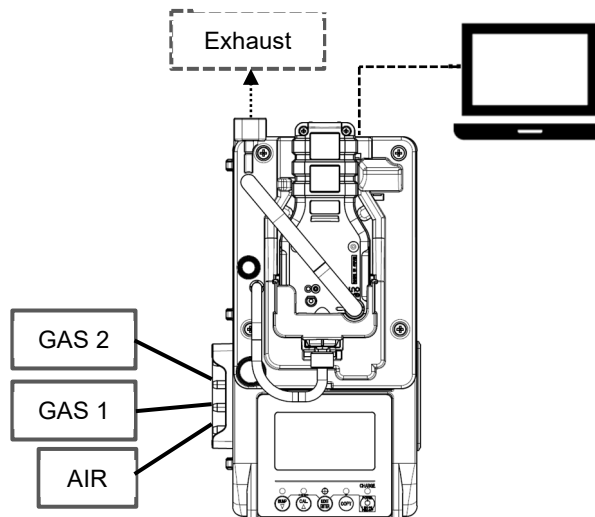

4-2-8. Installing the PC Controller Program (sold separately)

Using the PC Controller Program (sold separately), you can control gas adjustment and other operations using the product from the PC.

The PC Controller Program (sold separately) must be installed before it can be used.

NOTE

- A USB cable (Type-A male - Type-B male) (sold separately) must be used to connect the product to a PC.
- The PC must meet the following system requirements to use the PC Controller Program (sold separately):

Item	Requirements
Operating system (OS)	Windows® 10 or Windows® 11
Processor	Pentium® 2 or equivalent processor operating on an IBM® compatible PC (minimum requirements)
Memory	32 MB RAM (minimum)
Available hard disk space	32 MB (minimum)
Ports	An available USB port

<Installation>

- 1 Insert the PC Controller Program installation CD into the CD-ROM drive of the PC.**

The installation screen will appear automatically after a short while. if the PC does not support automatic CD-ROM startup, open the CD-ROM drive in Explorer, then double-click on the "setup.exe" file.

Note: Install using a user account with administrator rights.

The installer preparation screen appears.

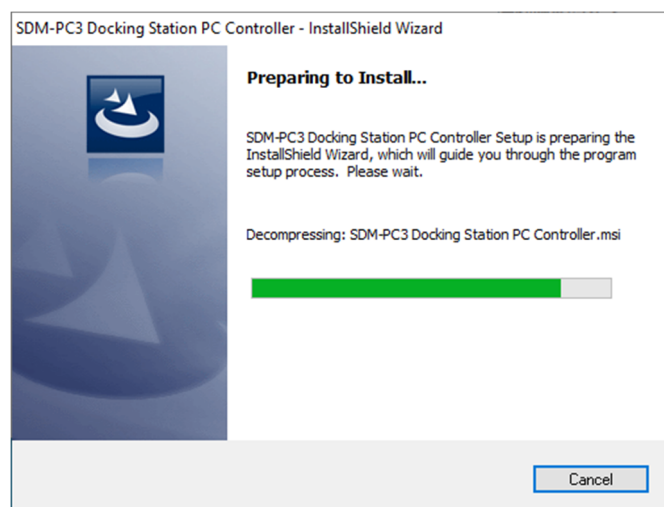
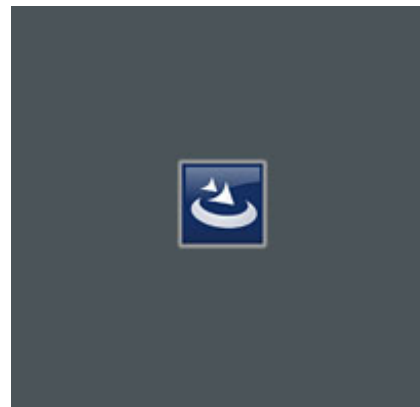

2 Click [Next].



3 Check the details displayed, select [I accept the terms in the license agreement], then click [Next].

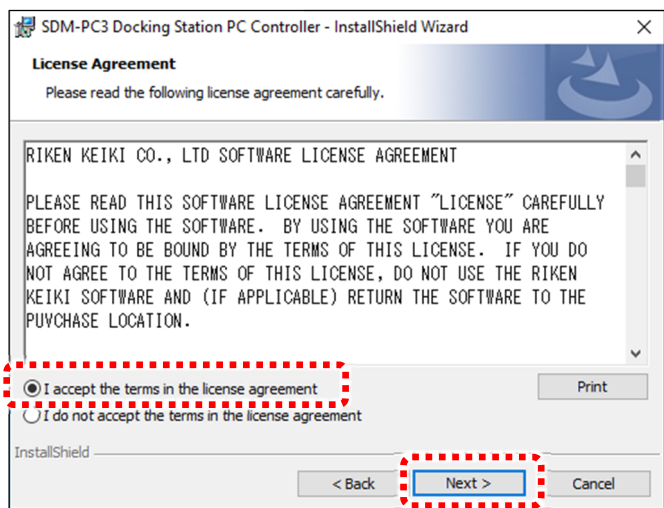

4 Enter the user name and organization, then click [Next].

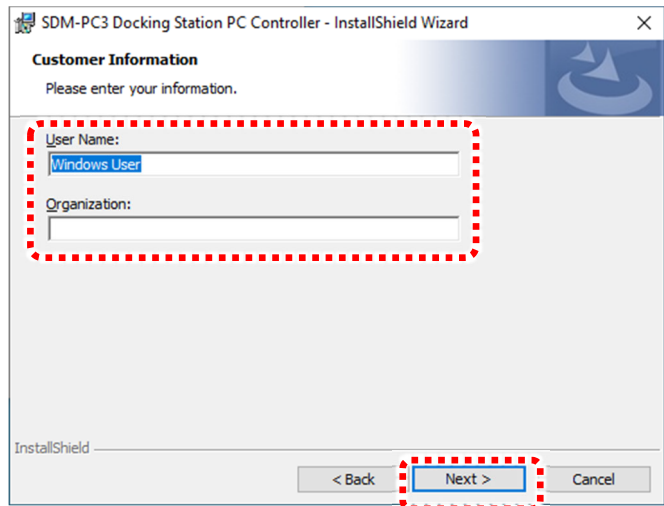

- 5** Select the destination folder for installing the software, then click [Next].

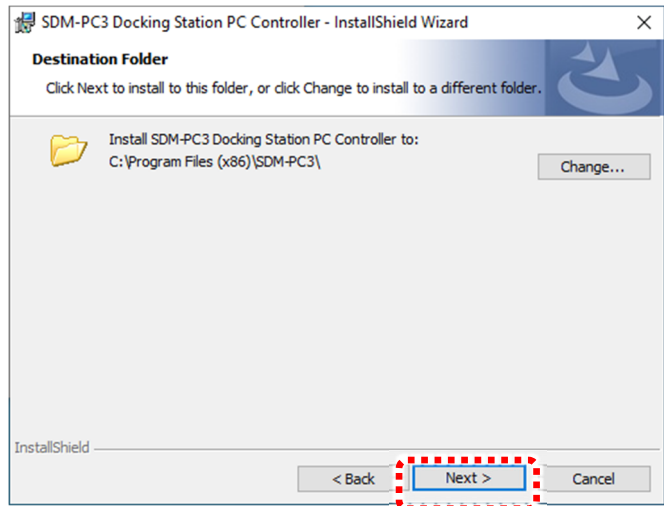

- 6** Check the setup type, destination folder, and user information, then click [Install].

To edit the settings or information, click [Back].
Click [Cancel] to exit the wizard.

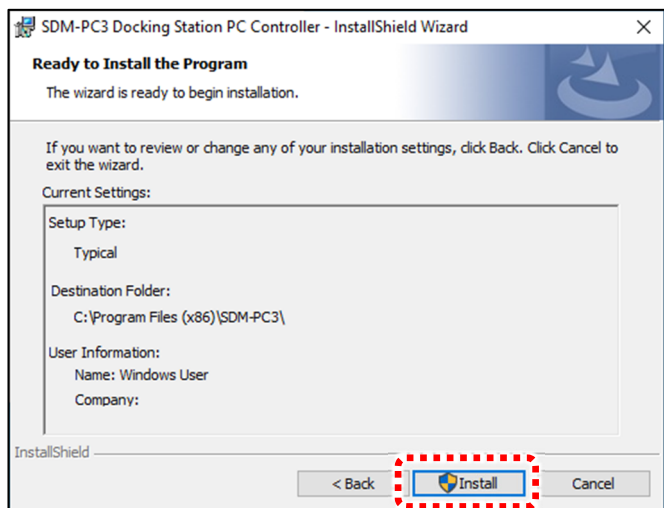

Program installation starts.

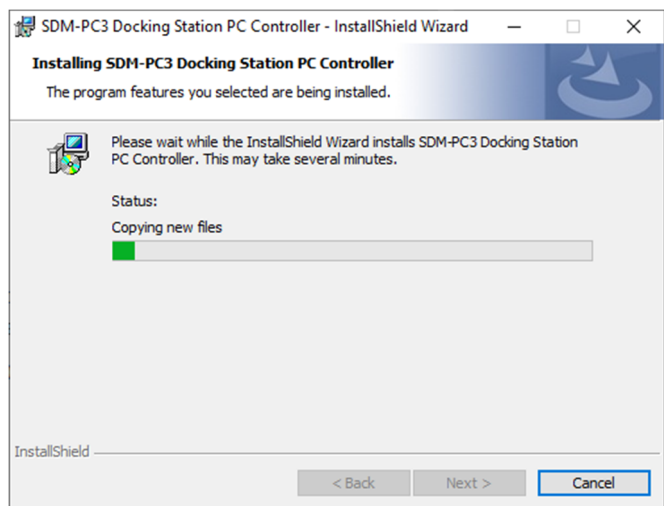

- 7** Once installation is complete, click [Finish].

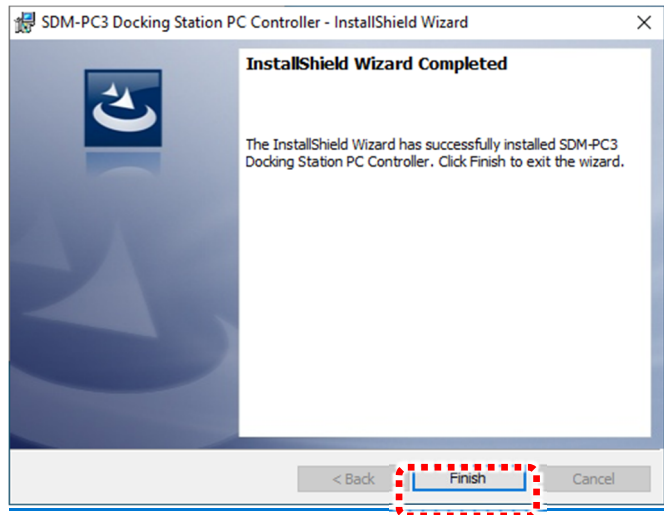

- 8** Check to confirm that the PC Controller Program icon appears on the PC desktop.





PC Controller Program icon

4-3. Startup

4-3-1. Turning on the power

Product LED check locations

	
Lit steadily	Blinking

- 1 Hold down the **POWER** button on the product for at least one second to turn on the power.

Panel sheet

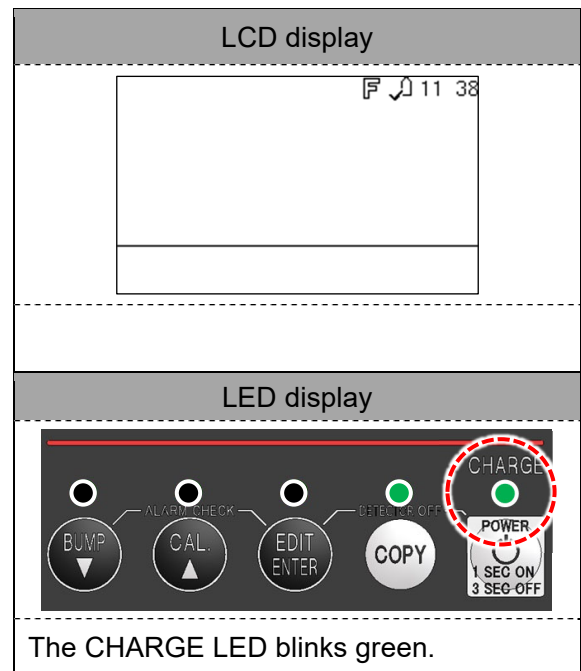

- 2 Mount the gas detector (sold separately) with its power turned off on the product. (Refer to '4-2-6. Mounting the gas detector (sold separately)').

Once mounted on the product, the power for the gas detector (sold separately) turns on and communication starts.

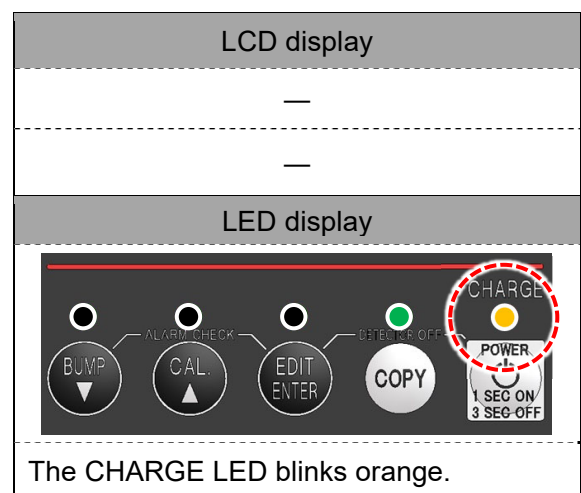

Once communication is established, the gas names and calibration gas concentrations set on the gas detector (sold separately) are displayed on the LCD.

LCD display	
Displays the gas names and calibration gas concentrations.	
LED display	
The CHARGE LED blinks green.	

NOTE

- Once communication is established, the gas detector (sold separately) clock is automatically synchronized with the product clock.

4-3-2. LCD screen display

The meanings of the icons displayed on the product LCD screen are as follows:

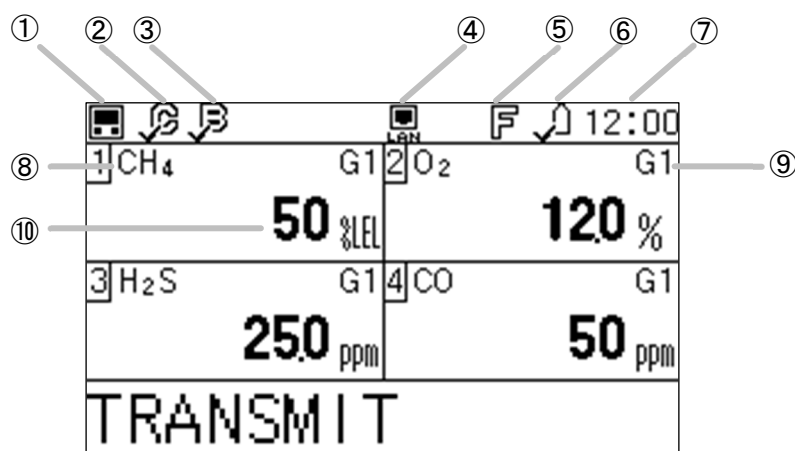

No.	Name	Function				
①	Gas detector connection	Displayed when communication is established between the product and the gas detector (sold separately). Pressing the POWER button does not turn off the product power when this icon is displayed.				
②	Gas adjustment expiration	Displayed when communication is established between the product and the gas detector (sold separately). These icons indicate whether a gas detector (sold separately) sensor has exceeded the gas adjustment expiration date.				
		<table border="1"> <tr> <td>Before gas adjustment expiration date</td> <td>Gas adjustment expiration warning</td> <td>Gas adjustment expired</td> </tr> <tr> <td></td> <td></td> <td></td> </tr> </table>	Before gas adjustment expiration date	Gas adjustment expiration warning	Gas adjustment expired	
Before gas adjustment expiration date	Gas adjustment expiration warning	Gas adjustment expired				
③	Bump test expiration	Displayed when communication is established between the product and the gas detector (sold separately). These icons indicate whether a gas detector (sold separately) sensor has exceeded the bump test expiration date.				
		<table border="1"> <tr> <td>Before bump test expiration date</td> <td>Bump test expiration warning</td> <td>Bump test expired</td> </tr> <tr> <td></td> <td></td> <td></td> </tr> </table>	Before bump test expiration date	Bump test expiration warning	Bump test expired	
Before bump test expiration date	Bump test expiration warning	Bump test expired				
④	LAN connection	Displayed when the product is connected to a hub or similar device via a LAN cable and communication is possible				
⑤	Fast bump test	Displayed when the fast bump test setting is enabled				
⑥	Cylinder expiration	These icons indicate whether the cylinder has exceeded the expiration date.				
		<table border="1"> <tr> <td>Before expiration date</td> <td>Expiration warning</td> <td>Expired</td> </tr> <tr> <td></td> <td></td> <td></td> </tr> </table>	Before expiration date	Expiration warning	Expired	
Before expiration date	Expiration warning	Expired				
⑦	Clock	Displays the time.				
⑧	Sensor name	Gas detector (sold separately) detection target gas name				
⑨	Cylinder setting	Displays the inlet used. (Refer to '4-4-2. Cylinder settings'.)				
		[G1] GAS 1				
		[G2] GAS 2				
		[G3] GAS 3				

No.	Name	Function	
⑨	Cylinder setting	[C1]	Replace the GAS 1 inlet gas.
		[C2]	Replace the GAS 2 inlet gas.
		[C3]	Replace the GAS 3 inlet gas.
		[**]	No assignment (cylinder information does not include a target gas)
		[-]	[OFF] in sensor setting
⑩	Gas concentration	Displays the calibration gas concentration for bump test/gas adjustment. The gas concentration for the cylinder being used, with the units matching the sensor's units.	

4-3-3. LED display list

The product LED indications are as follows:

<BUMP LED/CAL LED/ALARM LED>

Status		LED		
		BUMP	CAL	ALARM
Power on (for one second)		Orange	Orange	Orange
Button operation	Main screen	OFF	OFF	OFF
	Setting screen	OFF	OFF	OFF
Operation using the PC Controller Program (sold separately)	Download in progress	Orange (blinking)	Orange (blinking)	OFF
	Download complete	Orange	Orange	OFF
BUMP/CAL in progress	BUMP in progress	Orange (blinking)	OFF	OFF
	CAL in progress	OFF	Orange (blinking)	OFF
	CAL in progress after BUMP failed	Orange (blinking)	Orange (blinking)	OFF
BUMP/CAL results (Normal)	BUMP all successful (CAL = OFF after failure)	Green	OFF	(Alarm check results)
	BUMP failed	Red	OFF	
	CAL all successful	OFF	Green	
	CAL failed	OFF	Red	
	BUMP all successful (CAL = ON after failure)	Green	OFF	
	BUMP failed, CAL all successful	Red	Green	
BUMP/CAL results (Error)	BUMP failed, CAL failed	Red	Red	(Alarm check results)
	Zero adjustment failed (CAL = OFF after failure)	Red (blinking)	OFF	
	Communication error (CAL = OFF after failure)	Red	OFF	
	Low flow rate (CAL = OFF after failure)	Green (blinking)	OFF	
	Zero adjustment failed (CAL)	OFF	Red (blinking)	
	Communication error (CAL)	OFF	Red	
	Low flow rate (CAL)	OFF	Green (blinking)	
	Zero adjustment failed (CAL = ON after failure)	Red (blinking)	OFF	
	Communication error (CAL = ON after failure, BUMP in progress)	Red	Red	
	Low flow rate (CAL = ON after failure, BUMP in progress)	Green (blinking)	Green (blinking)	
	Communication error (CAL = ON after failure, CAL in progress)	Red	Red	
Alarm check in progress	Low flow rate (CAL = ON after failure, CAL in progress)	Green (blinking)	Green (blinking)	Orange (blinking)
	Alarm check in progress	OFF	OFF	
	Alarm check in progress (after BUMP)	Orange (blinking)	OFF	
	Alarm check in progress (after BUMP)	Orange	Orange (blinking)	
Alarm check results	Alarm check in progress (after CAL)	OFF	Orange (blinking)	Orange (blinking)
	Alarm check successful	(BUMP/CAL results)		Green
Alarm check failed		(BUMP/CAL results)		Red

* The BUMP and CAL LEDs blink rapidly for the fast bump test.

<COPY LED>

Status		LED
Power on (for one second)		Orange
No USB flash drive (sold separately)	No data	OFF
	Small data volumes (Under 80 %: 1 to 399)	Green
	Large data volumes (80 % or more: 400 to 499)	Orange
	Max data (100 %: 500)	Red
USB flash drive (sold separately) present	No data	OFF
	Small data volumes (Under 80 %: 1 to 399)	Green (blinking)
	Large data volumes (80 % or more: 400 to 499)	Orange (blinking)
	Max data (100 %: 500)	Red (blinking)
	Data copying in progress	Red
	Logger data download in progress	Orange (blinking)

<POWER LED>

Status	LED
Power on (for one second)	Orange
Self-diagnostic error	Red
Normal	Green (blinking)
Charging in progress	Orange (blinking)
Charging complete	Green
Charging error	Red

4-4. Settings

Hold down the EDIT/ENTER button for at least three seconds with a gas detector (sold separately) mounted on the product to display various setting menus.

[BUMP] (bump test settings)

[AIR FLUSH]	Duration for which air is aspirated
[GAS TIME]	Duration for which the bump test gas is drawn
[AIR PURGE]	Duration for air purging of the bump test gas
[TOLERANCE]	Threshold for determining pass/fail of a bump test
[AUTO CAL]	<p>Sets automatic gas adjustment to start if a bump test fails. The gas introduction time will be the difference from the gas adjustment setting. (Example: If the bump test gas introduction time setting is 25 seconds and the gas adjustment setting is 60 seconds, gas adjustment will be performed by drawing in gas for 35 seconds after FAIL.)</p> <p>If the gas adjustment setting is shorter, gas adjustment will start as soon as FAIL occurs.</p> <p>When testing multiple sensors using a single gas (gas mixture), even the sensors that have passed (PASS) in addition to those that have failed (FAIL) will undergo gas adjustment.</p>
[FAST BUMP]	<p>Function that issues a PASS result as soon as the pass threshold for the bump test is reached, even before the gas introduction time has elapsed. This minimizes gas consumption if the sensor reacts normally.</p> <p>An assessment is made at 10 seconds after each gas drawing starts.</p> <p>When testing multiple sensors using a single gas (gas mixture), a PASS result is issued when all of the sensors under test reach the pass threshold at the same time.</p>
[ALARM CHECK]	Function for testing the alarm LED arrays and buzzer of the gas detector (sold separately) when a bump test has ended. In the test, the alarm LED arrays flash for several seconds and the buzzer sounds, and the product assesses whether these are operating correctly.
[BUMP EXPIRED]	Sets so that the bump test starts automatically when a gas detector (sold separately) for which the bump test has expired is connected.
[AUTO EXEC]	Sets so that the bump test starts automatically when a gas detector (sold separately) is connected.

[CAL] (CALIBRATION) (gas adjustment settings)

[AIR FLUSH]	Duration for which air is aspirated
[GAS TIME]	Duration for which the calibration gas is drawn
[AIR PURGE]	Duration for air purging of the calibration gas
[ALARM CHECK]	Function for testing the alarm LED arrays and buzzer of the gas detector (sold separately) when gas adjustment has ended. In the test, the alarm LED arrays flash for several seconds and the buzzer sounds, and the product assesses whether these are operating correctly.
[CAL EXPIRED]	Sets so that gas adjustment starts automatically when a gas detector (sold separately) for which gas adjustment has expired is connected.
[AUTO EXEC]	Sets so that gas adjustment starts automatically when a gas detector (sold separately) is connected.
[MANUAL CAL]	Sets so that gas adjustment can be performed by pressing the CAL button. If set to [OFF], gas adjustment will not be performed even when the CAL button is pressed. [AUTO CAL] in the [BUMP] settings will also be set to [OFF].
[CO2 ZERO CAL]	Not used with this product

[CYLINDER]

(CYLINDER NAME)	Name for identifying the cylinder Displayed when setting other items
(PART NUMBER)	Cylinder part number
(SERIAL NUMBER)	Cylinder serial number
[EXPIRY DATE]	The cylinder expiration icon appears on the LCD screen to notify this date has passed or is approaching. No changes will occur other than the icon notification.
[ACTIVE]	Cylinder enabled/disabled setting Cylinders set to [OFF] will not be used.
[ACTUAL GAS]	Not used with this product
[BUMP AIR FLUSH]	Duration for which air is aspirated in the bump test when this cylinder is used
[BUMP AIR PURGE]	Duration for air purging in the bump test when this cylinder is used
[CAL AIR FLUSH]	Duration for which air is aspirated in gas adjustment when this cylinder is used
[CAL AIR PURGE]	Duration for air purging in gas adjustment when this cylinder is used
[BUMP GAS TIME]	Duration for introducing gas in the bump test when this cylinder is used
[CAL GAS TIME]	Duration for introducing gas in gas adjustment when this cylinder is used
[IR GAS TIME]	Not used with this product
[IR WAIT TIME]	Not used with this product
[SH SENSOR]	Not used with this product
[SH BUMP UPPER]	Not used with this product
[SH BUMP LOWER]	Not used with this product
(GAS NAME)	Gas component(s) contained in the cylinder (up to six types)
[GAS VALUE]	Gas concentration
[BUMP TOLERANCE]	Bump tolerance for the bump test using this gas
[CLEAR EXEC]	Resets the cylinder.

[INLET]

[INLET GAS1]	Sets the cylinder connected to GAS 1.
[INLET GAS2]	Sets the cylinder connected to GAS 2. This setting will be disabled if GAS 2 is not available due to the internal solenoid valves.
[INLET GAS3]	Sets the cylinder connected to GAS 3. This setting will be disabled if GAS 3 is not available due to the internal solenoid valves.
[INLET BASE]	Not used with this product

[SENSOR]

[GAS01: {sensor name}]	Setting to [OFF] disables the bump test and gas adjustment for that sensor. The default setting is [OFF] for the gas detector (sold separately) TYPE CH H ₂ sensor only. When set to [OFF], the gas name and calibration gas concentration are not displayed on the LCD screen.
[GAS02: {sensor name}]	
[GAS03: {sensor name}]	
[GAS04: {sensor name}]	

The sensor menu is not displayed when communication is not established with the gas detector (sold separately).

The ON/OFF settings are stored in the product, and the same settings are used when a gas detector (sold separately) with the same sensor combination is connected.

[DATE]

(DATE)	Displays the current date and sets the clock.
(TIME)	Displays the current time and sets the clock.
(DATE FORMAT)	Format for dates displayed on the product

[LANGUAGE]

-	Product display language
---	--------------------------

[SYSTEM]

[LCD]	[LCD CONTRAST]	Product LCD display contrast
[POWER SAVE]	[WAIT TIME]	Time until the gas detector (sold separately) power and LCD backlight are turned off if no buttons are operated on the product
	[WAIT TIME(PASS)]	Time until the gas detector (sold separately) power and LCD backlight are turned off if no buttons are operated on the product after the bump test, gas adjustment, and alarm check results are all successful
[DATA LOGGER]	[AUTO DOWNLOAD]	Automatically downloads the logger data and saves to a USB flash drive when a gas detector (sold separately) is connected to the product.
	[INTERVAL]	Expiration interval for automatic download Logger data is downloaded only if a logger data file previously downloaded using the same gas detector (sold separately) exists on the USB flash drive and the difference between the file time stamp exceeds this value.
	[MANUAL DOWNLOAD]	Sets whether logger data can be downloaded by holding down the COPY button.
[EXPIRE NOTICE]	[BUMP ICON]	Displays/hides the bump test expiration icon.
	[CAL ICON]	Displays/hides the gas adjustment expiration icon.
	[CYL ICON]	Displays/hides the cylinder expiration icon.
	[BUMP WARN DAYS]	Number of days before expiration for which the warning icon is displayed
	[CAL WARN DAYS]	Number of days before expiration for which the warning icon is displayed
	[CYL WARN DAYS]	Number of days before expiration for which the warning icon is displayed
[PASSWORD]	[ON]/[OFF]	Sets whether a password entry is required to access the setting screen.
	[PASSWORD]	Four-digit password
[AUTOMATIC EXEC]	[TYPE]	This function automatically performs a bump test, gas adjustment, and alarm check at the specified time. The bump test and gas adjustment are not performed for sensors that require gas replacement.
	[EXEC TIME]	Time for automatic execution. The gas detector (sold separately) power is turned on if it is off at the specified time.
	[SUN.] to [SAT.]	Specifies the days of the week for automatic execution. Automatic execution will not occur if all days are [OFF].
[NETWORK (CONFIG)]	[DHCP]	Function for connecting to the DHCP server to acquire the IP address, subnet mask, and default gateway
	[IP ADDR]	Product IP address. Used when [DHCP] is set to [OFF]
	[SUBNET M]	Product network range. Used when [DHCP] is set to [OFF]
	[DEF GW]	Gateway server IP address. Used when [DHCP] is set to [OFF]
[NETWORK (STATUS)]	[MAC ADDR]	Product MAC address
	[IP ADDR]	Current network values
	[SUBNET M]	
	[DEF GW]	The acquired value is displayed when [DHCP] is set to [ON] and acquisition from the DHCP server is successful. When [DHCP] is [OFF], the values set in [NETWORK (CONFIG)] are normally displayed. If the setting is changed, the values before the change will be displayed until the product restarts to reflect the change.

[SDM INFO]	[ROM/SUM]	Product version
	[INST NUMBER 1]	Base unit serial number
	[INST NUMBER 2]	Type specific unit serial number
[UPDATE]		Refer to '4-5-4. Updating firmware'.

4-4-1. Setting list

Menu		Item	Default value	Setting range
[BUMP]		[AIR FLUSH]	15 seconds	15 to 180 seconds
		[GAS TIME]	25 seconds	20 to 120 seconds
		[AIR PURGE]	15 seconds	5 to 180 seconds
		[TOLERANCE]	±50 %	±10 to 50 %
		[AUTO CAL]	[ON]	[ON] or [OFF]
		[FAST BUMP]	[ON]	[ON] or [OFF]
		[ALARM CHECK]	[ON]	[ON] or [OFF]
		[BUMP EXPIRED]	[OFF]	[ON] or [OFF]
	[AUTO EXEC]	[OFF]	[ON] or [OFF]	
[CAL]		[AIR FLUSH]	15 seconds	15 to 180 seconds
		[GAS TIME]	60 seconds	20 to 120 seconds
		[AIR PURGE]	15 seconds	5 to 180 seconds
		[ALARM CHECK]	[ON]	[ON] or [OFF]
		[CAL EXPIRED]	[OFF]	[ON] or [OFF]
		[AUTO EXEC]	[OFF]	[ON] or [OFF]
		[MANUAL CAL]	[ON]	[ON] or [OFF]
	[CO2 ZERO CAL]	[N2]	[N2], [GAS1(CO2 0ppm)], [400ppm], or [USER FILTER]	
[CYLINDER] [01] to [12] + Cylinder name	[BASIC INFO]	(CYLINDER NAME)	-	-
		(PART NUMBER)	-	-
		(SERIAL NUMBER)	-	-
		[EXPIRY DATE]	2099/12/31	2024/1/1 to 2099/12/31
		[ACTIVE]	[ON]	[ON] or [OFF]
	[DETAIL INFO]	[ACTUAL GAS]	[ON]	[ON] or [OFF]
		[BUMP AIR FLUSH]	[COMMON]	[COMMON] or 15 to 180 seconds
		[BUMP AIR PURGE]	[COMMON]	[COMMON] or 5 to 180 seconds
		[CAL AIR FLUSH]	[COMMON]	[COMMON] or 15 to 180 seconds
		[CAL AIR PURGE]	[COMMON]	[COMMON] or 5 to 180 seconds
		[BUMP GAS TIME]	[COMMON]	[COMMON] or 20 to 120 seconds
		[CAL GAS TIME]	[COMMON]	[COMMON] or 20 to 120 seconds
		[IR GAS TIME]	15 seconds	10 to 120 seconds
		[IR WAIT TIME]	10 seconds	10 to 120 seconds
		[SH SENSOR]	[OFF]	[ON] or [OFF]
	[SH BUMP UPPER]	-	-	
	[SH BUMP LOWER]	-	-	
	[GS1] to [GS6]	(GAS NAME)	-	-
		[GAS VALUE] (value)	0	0.0000 to 99999.9999
		[GAS VALUE] (units)	Vol%	%LEL, ppm, ppb, %, or vol%
[BUMP TOLERANCE]		[COMMON]	[COMMON] or 10 to 50 %	
[CLEAR EXEC]		-	-	
[INLET]		[INLET GAS1]	[CYLINDER1]	[OFF] or [CYLINDER1] to [CYLINDER12]
		[INLET GAS2]	[OFF]	[OFF] or [CYLINDER1] to [CYLINDER12]
		[INLET GAS3]	[OFF]	[OFF] or [CYLINDER1] to [CYLINDER12]
		[INLET BASE]	[OFF]	[OFF] or [CYLINDER1] to [CYLINDER12]
SENSOR		[01: {gas name}]	[ON]	[ON] or [OFF]
		[02: {gas name}]	[ON]	[ON] or [OFF]
		[03: {gas name}]	[ON]	[ON] or [OFF]
		[04: {gas name}]	[ON]	[ON] or [OFF]

[DATE]	[DATE]		-	-	
	[TIME]		-	-	
	[DATE FORMAT]		[YYYY/MM/DD]	[MM/DD/YYYY], [DD/MM/YYYY], or [YYYY/MM/DD]	
[LANGUAGE]			[ENGLISH]	Up to 17 languages	
[SYSTEM]	[LCD]	[LCD CONTRAST]	25	1 to 50	
	[POWER SAVE]	[WAIT TIME]	10 minutes	0 seconds to 23 hours 59 minutes 59 seconds	
		[WAIT TIME(PASS)]	15 seconds	0 seconds to 23 hours 59 minutes 59 seconds	
	[DATA LOGGER]	[AUTO DOWNLOAD]	[OFF]	[ON] or [OFF]	
		[INTERVAL]	1 day	1 to 60 days	
		[MANUAL DOWNLOAD]	[ON]	[ON] or [OFF]	
	[EXPIRE NOTICE]	[BUMP ICON]	[ON]	[ON] or [OFF]	
		[CAL ICON]	[ON]	[ON] or [OFF]	
		[CYL ICON]	[ON]	[ON] or [OFF]	
		[BUMP WARN DAYS]	10 days	0 to 180 days	
		[CAL WARN DAYS]	10 days	0 to 180 days	
	[PASSWORD]	[CYL WARN DAYS]	10 days	0 to 180 days	
		[ON] or [OFF]	[OFF]	[ON] or [OFF]	
		[PASSWORD]	0000	0000 to 9999	
	[AUTOMATIC EXEC]	[TYPE]	[BUMP]	[BUMP], [CALIBRATION], or [ALARM CHECK]	
		[EXEC TIME]	00:00	00:00 to 23:59	
		[SUN.] to [SAT.]	[OFF]	[ON] or [OFF]	
	[NETWORK]	[CONFIG]	[DHCP]	[ON]	[ON] or [OFF]
			[IP ADDR]	0.0.0.0	0.0.0.0 to 255.255.255.255
			[SUBNET M]	255.255.255.0	0.0.0.0 to 255.255.255.255
			[DEF GW]	0.0.0.0	0.0.0.0 to 255.255.255.255
		[STATUS]	[MAC ADDR]	-	-
			[IP ADDR]	-	-
[SUBNET M]			-	-	
[SDM INFO]	[DEF GW]	-	-		
	[ROM/SUM]	-	-		
	[INST NUMBER 1]	-	-		
[UPDATE]	[INST NUMBER 2]	-	-		
		-	-		

<[COMMON]>

If [COMMON] is set for the following items for which it is available, the values set for the bump test and gas adjustment will be used. If multiple cylinders are used for a single bump test or gas adjustment and the air flush or air purge time values do not match between the cylinders, the longest will be used.

- [BUMP AIR FLUSH]
- [BUMP AIR PURGE]
- [CAL AIR FLUSH]
- [CAL AIR PURGE]
- [BUMP GAS TIME]
- [CAL GAS TIME]
- [BUMP TOLERANCE]

NOTE

- Using the product together with the PC Controller Program (sold separately)
The ability to alter gas detector (sold separately) and product settings using the PC Controller Program (sold separately) is outlined in the following table:

Setting item	Can gas detector settings be altered?	Can product settings be altered?
Items that can be altered by right-clicking the display icon, then selecting [Edit] ^{*1} <ul style="list-style-type: none">Cylinder settingsCalibration gas concentration for bump test/gas adjustmentGas alarm setpoints, etc.	Y	Y
Items that can be altered by selecting [Config] ^{*2} displayed at the top right of the PC software screen <ul style="list-style-type: none">Bump test settingsGas adjustment settings, etc.	N	N

*1: Password entry is required to select [Edit]. Password (default): 1939

*2: Password entry is required to select [Config]. Password (default): ABCDE

4-4-2. Cylinder settings

Information on the cylinders used and the connection status of the cylinders and inlets is input to the product to perform the bump test and gas adjustment on the product.

NOTE

- Up to 12 items of cylinder settings can be stored.

《Example 1: GX-Force: CH₄, O₂, CO, H₂S; SDM-Force(C2): two solenoid valve》

- Cylinder A: CH₄ (25,000 ppm), O₂ (12.0 %), CO (50 ppm)
- Cylinder B: H₂S (25 ppm)

1 Set unused cylinder 01 to [OFF] (disabled).



2 Enter CH₄ gas information for cylinder A assigned as cylinder 02 (default name [CYL02]).

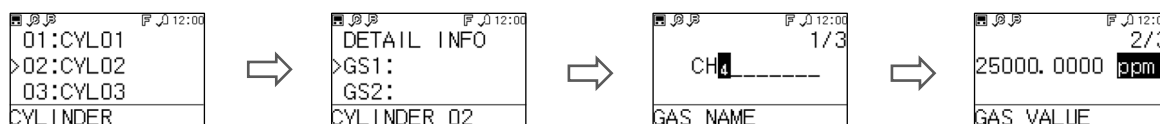

3 Enter O₂ and CO gas information in the same way.

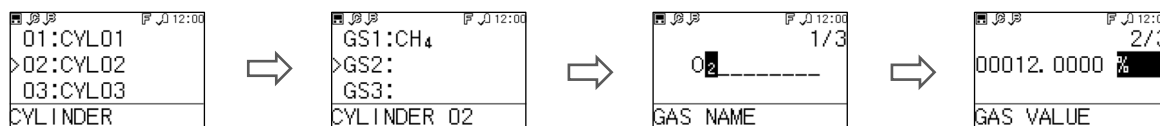

4 Enter H₂S gas information for cylinder B assigned as cylinder 03 (default name [CYL03]).



5 Connect cylinder A to GAS 1 and cylinder B to GAS 2 on the product.

6 Set [CYL02] for [GAS1] and [CYL03] for [GAS2] in the inlet settings.

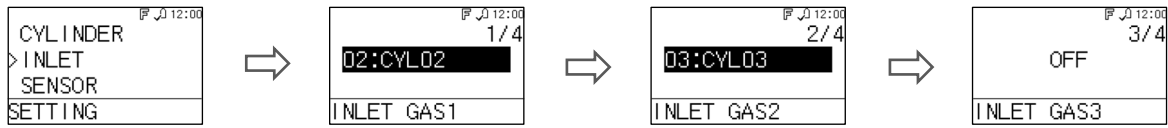

* The GAS 3 inlet and the base unit will be disabled.

7 Select [ESCAPE] to exit the setting screen.

All of the sensor assignments are displayed.

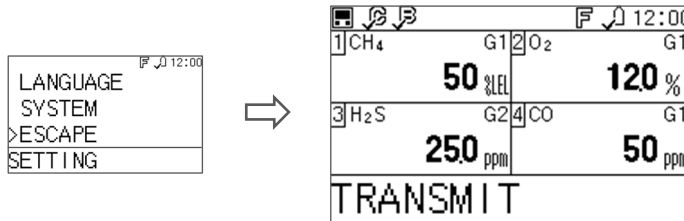

8 Start the bump test/gas adjustment.

The product draws in gas from GAS 1 and performs the bump test/gas adjustment on the CH₄, O₂, and CO sensors.

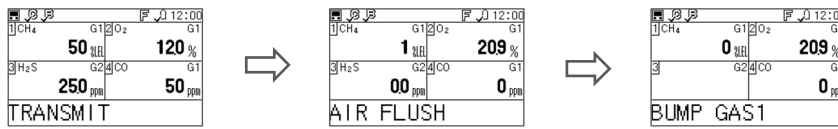

9 The product automatically switches to GAS 2 to draw in gas to perform the bump test/gas adjustment on the H₂S sensor and finish the process.



《Example 2: GX-Force: CH₄, O₂, CO, H₂S; SDM-Force(C1): one solenoid valve》

- Cylinder A: CH₄ (25,000 ppm), O₂ (12.0 %), CO (50 ppm)
- Cylinder B: H₂S (25 ppm)

1 Set in the same way as 1 to 4 in Example 1.

2 Connect cylinder A to GAS 1 on the product.

3 Set [CYL02] for [GAS1] in the inlet settings.



* The GAS 2 and GAS 3 inlets and the base unit will be disabled.

4 Select [ESCAPE] to exit the setting screen.
Each sensor's assignment results are displayed.

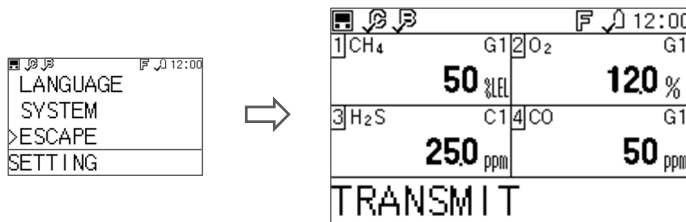

* On products containing one solenoid valve, the cylinder set to [GAS2] will automatically become subject to replacement and displayed as [C1].

5 Start the bump test/gas adjustment.

The product draws in gas from GAS 1 and performs the bump test/gas adjustment on the CH₄, O₂, and CO sensors.

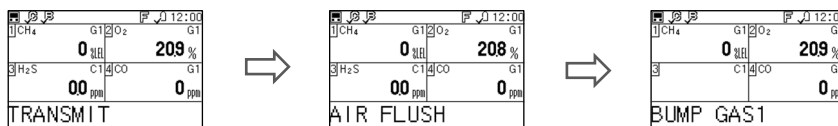

6 When the gas replacement screen appears, detach cylinder A from GAS 1, then connect cylinder B.

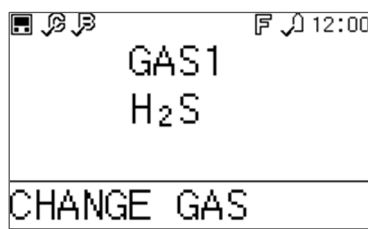

- 7 Press the EDIT/ENTER button to resume, then draw in gas from GAS 1 to perform the bump test/gas adjustment on the H₂S sensor.**

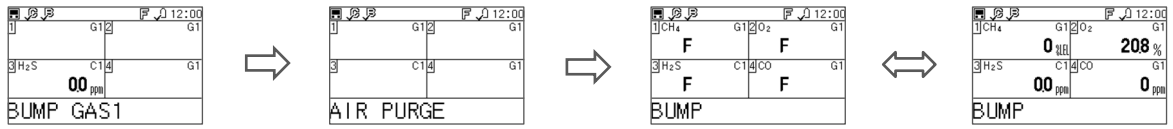

- 8 Detach cylinder B from GAS 1, then reconnect cylinder A.**



4-5. Operations using the product operation buttons

4-5-1. Bump test and gas adjustment procedure

NOTE

- The bump test or gas adjustment can be canceled midway by holding down the BUMP button or CAL button respectively for at least three seconds.
- Canceling during the initial air aspiration (AIR FLUSH) aborts the procedure immediately and the display returns to the main screen. In this case, the canceled procedure is not recorded in the product memory.
- Air aspiration (AIR PURGE) is performed if the procedure is canceled while gas is being drawn. [CANCEL] is displayed while air is being aspirated, and the result screen is displayed once the air aspiration has ended.
- If at least one bump test or gas adjustment has ended, the procedure is performed to the end, and the results are displayed. In this case, the results are also stored in the internal memory.
- The number of gas inlets that can be used on the product varies depending on the number of solenoid valves (one to three) contained.
- On products containing one solenoid valve, only gas inlet GAS 1 is available. To introduce more than one type of gas with this product type, the gas connected to the gas inlet on the product must be changed over manually.

Product LED check locations

	
Lit steadily	Blinking

- 1 Hold down the POWER button on the product for at least one second.

The power turns on.

Panel sheet

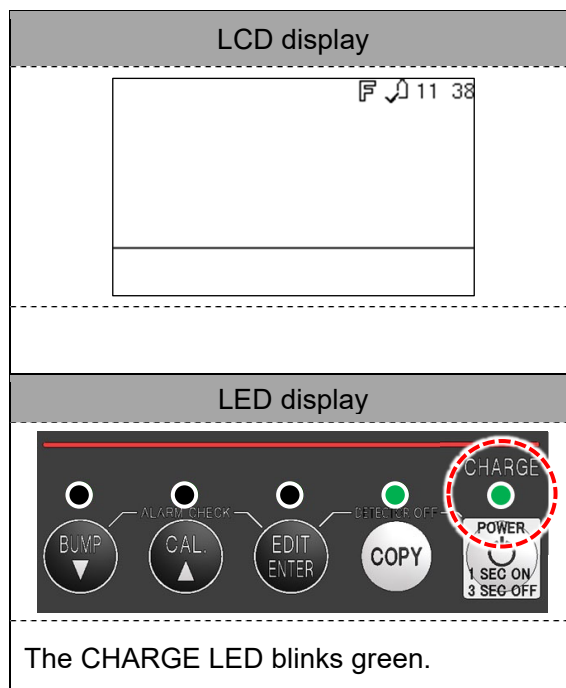
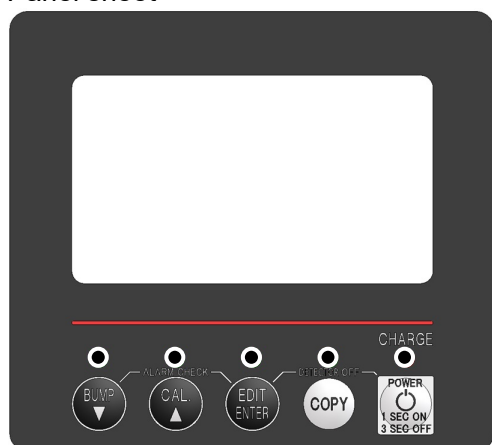

- 2** Mount the gas detector (sold separately) with its power turned off on the product.
(Refer to '4-2-6. Mounting the gas detector (sold separately)'.)

Once mounted on the product, the power for the gas detector (sold separately) turns on and communication starts.

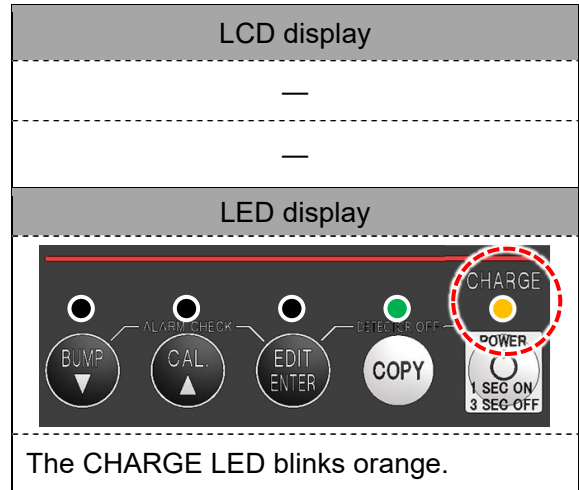

- 3** Once communication is established, the gas names and calibration gas concentrations set on the gas detector (sold separately) are displayed on the LCD.

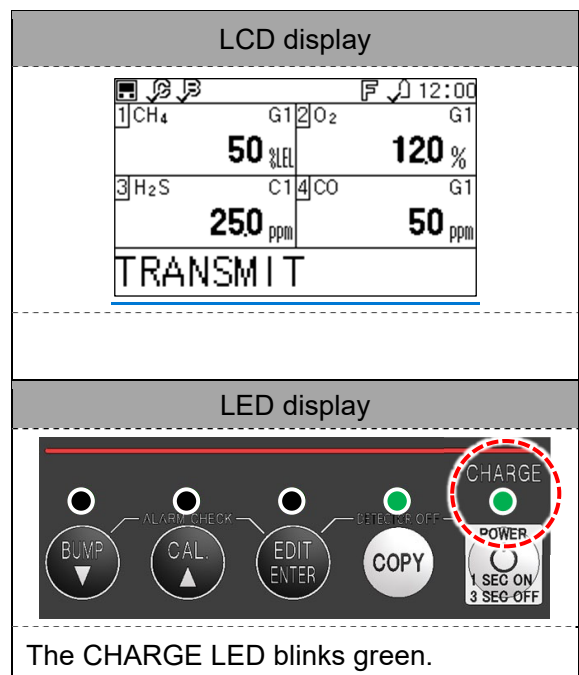

- 4 Press the BUMP button to start the bump test.

The bump test is performed for all gases.

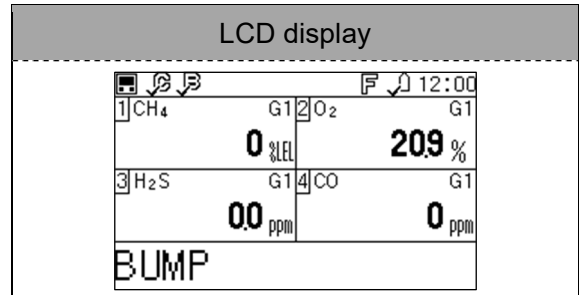

The current concentration is displayed while a bump test is in progress.

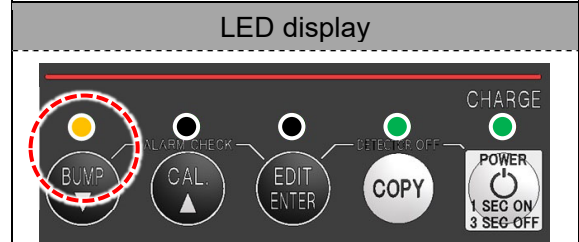

The BUMP LED blinks orange.

- 5 Press the CAL button to start gas adjustment.

Gas adjustment is performed for all gases. The current concentration is displayed while gas adjustment is in progress.

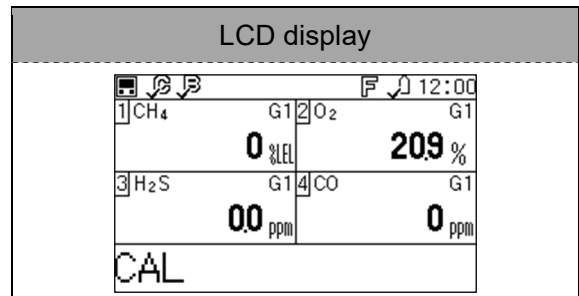

The current concentration is displayed while gas adjustment is in progress.

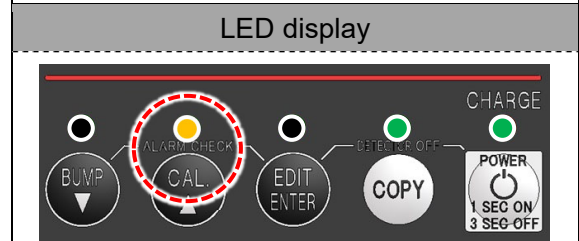

The CAL LED blinks orange.

<Common details for the bump test and gas adjustment>

- 6** Air is aspirated for zero adjustment.
Zero adjustment is performed for all sensors simultaneously.



* In the case of gas detectors with an O₂ sensor, air aspiration is extended for 40 seconds, after the gas detector (sold separately) is connected.

LCD display	
—	—
—	—
LED display	
—	—
—	—

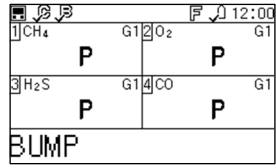

- 7** The bump test/gas adjustment is performed in the order set in the cylinder settings.
- The bump test/gas adjustment is performed from the gas set for [GAS1].
 - To use a gas not set for the inlet, exchange the gas before starting the procedure.

LCD display	
—	—
—	—
LED display	
—	—
—	—

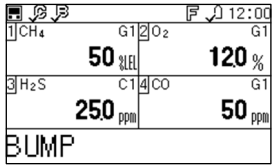
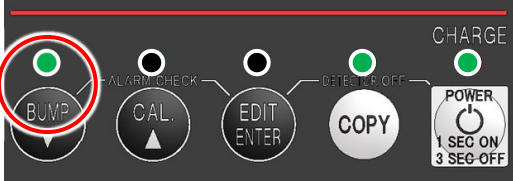
- 8** The results are displayed.
(Bump test example)

Bump test judgment results		Bump test result concentrations
		
[P] is displayed if successful, and [F] is displayed if failed.	Screens displayed alternately	The results are displayed on the gas detector (sold separately) screen.
LED display		
		
The BUMP LED lights up green if all bump tests were successful. The BUMP LED lights up red if even one bump test failed.		

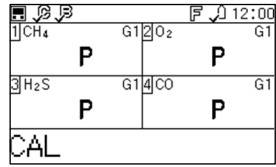
- 9** The results are displayed.
(Gas adjustment example)

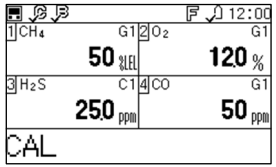
Gas adjustment results		Gas adjustment result concentrations
		
[P] is displayed if successful, and [F] is displayed if failed.	Screens displayed alternately	The results are displayed on the gas detector (sold separately) screen.

LED display

The CAL LED lights up green if all gas adjustments were successful.
The CAL LED lights up red if even one gas adjustment failed.

- 10** Press the BUMP button and EDIT/ENTER button simultaneously to start the alarm check.

LCD display

—

—

LED display

The EDIT/ENTER LED blinks orange.

- 11** Once the alarm check ends, the result screen is displayed, and the LED indication changes from blinking orange.
- * The LED lights up green if the alarm check for the alarm LED arrays and buzzer was successful.
 - The LED lights up red if the alarm check for both or either of the alarm LED arrays and buzzer failed.

LCD display

[P] is displayed if successful, and [F] is displayed if failed.

LED display

The EDIT/ENTER LED lights up green if the alarm check for the alarm LED arrays and buzzer was successful.



CAUTION

The alarm check may not operate correctly if the product is used in direct sunlight or in noisy locations.



4-5-2. Copying test/adjustment results to a USB flash drive (sold separately)

The results of bump tests, gas adjustment, and alarm checks performed on the product can be saved as files to a USB flash drive (sold separately).

NOTE

- Up to 500 data items can be stored in the product.
- If the product memory becomes full, the oldest data will be overwritten by new data.
- Data is saved as text files (.txt) in the DAT folder and as binary files (.bin).
- The file names begin with “SDM-Force”, and consist of the product serial number, suffixed by the date of the last test or gas adjustment performed.
Example: SDM-Force TEST0000003 240111.TXT
→ Data for the last test or gas adjustment performed on January 11, 2024 using the product with serial number TEST0000003
- The COPY LED color varies depending on the amount of memory space available. For details, refer to ‘4-3-3. LED display list’.
- USB flash drives with a built-in hub cannot be used.
- Data cannot be copied unless the USB flash drive (sold separately) has sufficient free space in which to copy the saved data.

Product LED check locations

	
Lit steadily	Blinking

- 1 Hold down the **POWER** button on the product for at least one second.

The product power turns on.

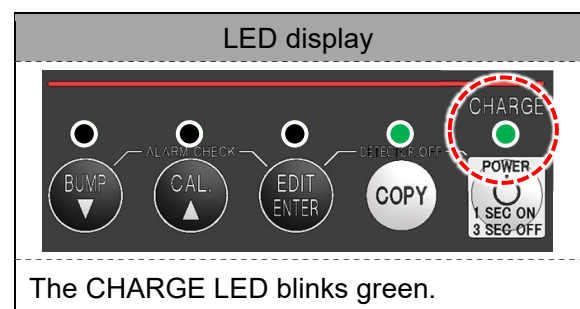

- 2 Insert the USB flash drive (sold separately) into the USB port on the front of the product.

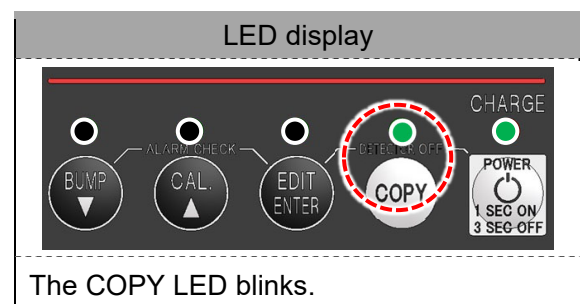

3 Hold down the COPY button on the product until the COPY LED lights up red.

The bump test, gas adjustment, and alarm check data stored in the product is copied to the USB flash drive (sold separately).
Once copying is complete, the COPY LED returns to its previous state.

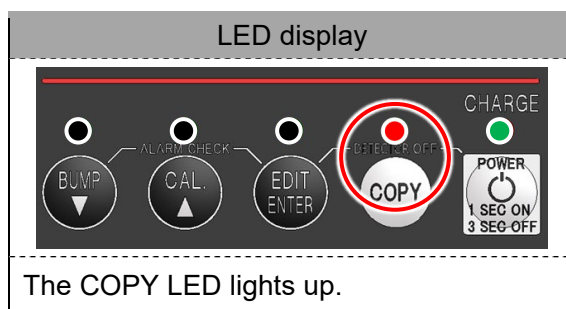

NOTE

- Holding down the CAL/▲ button and COPY button together for at least three seconds after turning on the product power in step 1 clears all of the data inside the product. The COPY LED goes out after the memory has been cleared.

<Example of recorded data>

• Bump test

Model	:	GX-Force			
Serial No	:	1Z6010127RN			
Station ID	:	-----			
User ID	:	-----			
SDM Model	:	SDM-Force			
SDM Serial No	:	SDM-Force_20231227			
Date Time	:	2024/03/05 10:48:32			
Item	:	BUMP TEST			
Gas Name	:	CH4(%LEL)	O2(%)	H2S (ppm)	CO (ppm)
Full Scale	:	100	40.0	200.0	2000
Test Gas	:	50	12.0	25.0	50
Test Result	:	49	12.0	25.0	10
Pass/Fail?	:	PASS	PASS	PASS	FAIL

▪ Gas adjustment

Model : GX-Force
Serial No : 1Z6010127RN
Station ID : -----
User ID : -----
SDM Model : SDM-Force
SDM Serial No : SDM-Force_20231227
Date Time : 2024/03/06 10:48:32
Item : CALIBREATION

Gas Name	CH4(%LEL)	O2(%)	H2S (ppm)	CO (ppm)
Full Scale	100	40.0	200.0	2000
Cal Gas	50	12.0	25.0	50
Before Cal	45	11.0	30.0	55
After Cal	50	12.0	30.0	50
Pass/Fail?	PASS	PASS	FAIL	PASS

▪ Alarm check

Model : GX-Force
Serial No : 1Z6010127RN
Station ID : -----
User ID : -----
SDM Model : SDM-Force
SDM Serial No : SDM-Force_20231227
Date Time : 2024/03/06 10:48:32
Item : ALARM CHECK
Test Type : LED BUZZER
Pass/Fail? : PASS PASS

4-5-3. Downloading gas detector (sold separately) logger data

Logger data saved in a gas detector (sold separately) can be downloaded to a USB flash drive (sold separately). The downloaded data can then be imported into the PC Controller Program (sold separately).

NOTE

- The data is saved as binary files in the DAT folder.
- The PC Controller Program (sold separately) and a USB cable (Type-A male - Type-B male) (sold separately) are required in order to import downloaded data. For information on how to install the PC Controller Program (sold separately), refer to '4-2-8. Installing the PC Controller Program (sold separately)'.
- The file names are made up of the gas detector (sold separately) model and the serial number. Example: GX-Force 860010016RK.DAT
→ Logger data for the gas detector (sold separately) model GX-Force with serial number 860010016RK

- 1 Hold down the POWER button on the product for at least one second.**

The product power turns on.

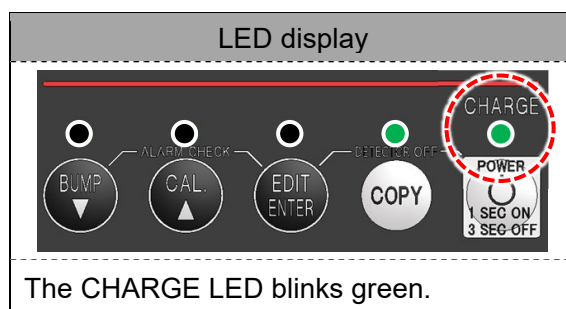

- 2 Mount the gas detector (sold separately) with its power turned off on the product.**
(Refer to '4-2-6. Mounting the gas detector (sold separately)'.)

Once mounted on the product, the power for the gas detector (sold separately) turns on and communication starts.

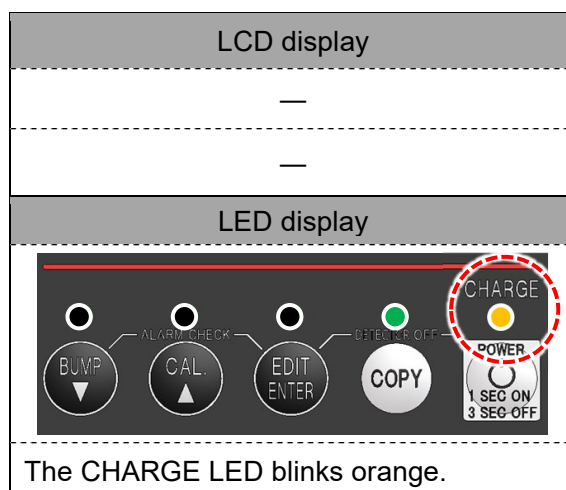

- 3** Once communication is established, the gas names and calibration gas concentrations set on the gas detector (sold separately) are displayed on the LCD.

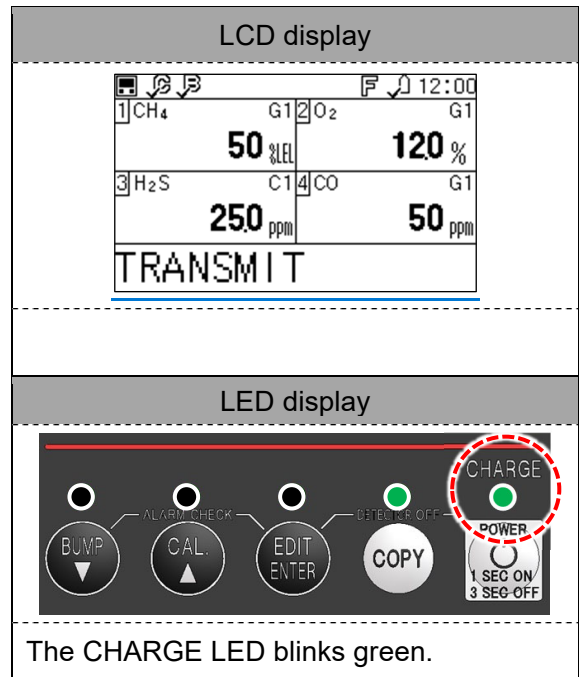

- 4** Insert the USB flash drive (sold separately) into the USB port on the front of the product.

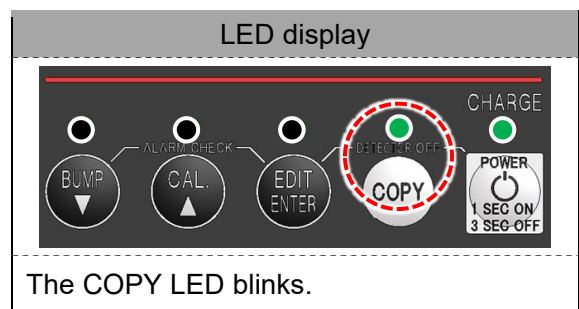

- 5** Hold down the COPY button on the product until the COPY LED lights up red and then blinks orange.

The product downloads the gas detector (sold separately) logger data to the USB flash drive (sold separately).
 Downloading can be canceled by holding down the COPY button here.

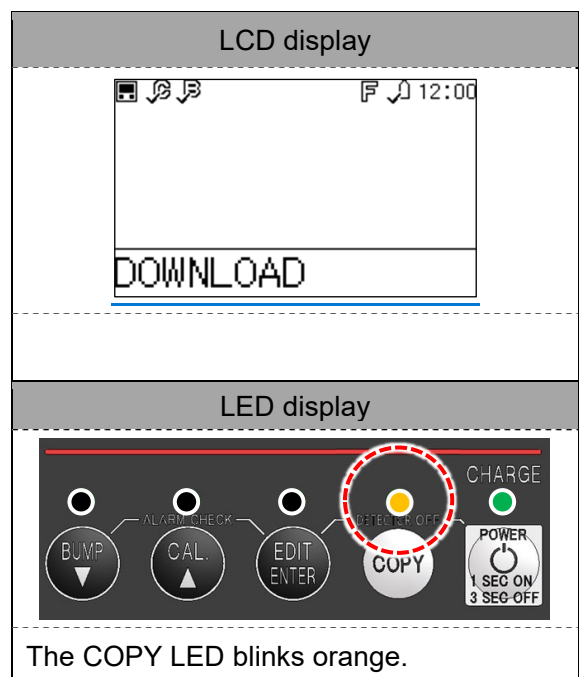

- 6 Once downloading is complete, the gas detector (sold separately) display returns to the previous screen, and the COPY LED returns to its previous state.

LCD display

1 CH ₄ 50 %LEL		G1 2 O ₂ 120 %	
3 H ₂ S 250 ppm		C1 4 CO 50 ppm	
TRANSMIT			

LED display

The LED display panel features several components: a BUMP button with a downward arrow, a CAL. button with an upward arrow, an EDIT ENTER button, a COPY button with a green LED indicator, and a POWER button with a power symbol and '1 SEC ON / 3 SEC OFF' text. Above the buttons are three small circular indicators labeled 'ALARM CHECK' and 'DET BLEB OFF'. A 'CHARGE' indicator with a green LED is located to the right of the COPY button. The COPY LED is circled in red.

The COPY LED blinks.

4-5-4. Updating firmware

A USB flash drive (sold separately) can be used to update the product firmware. There are two sets of firmware for the product: one for the base unit and one for the type specific unit. These can be updated at the same time or separately.



CAUTION

If the product power is cut off while the firmware is being updated, the product may not restart.

<USB flash drive (sold separately) preparation>

- ① Create a folder named “update” on the USB flash drive (sold separately).
- ② Copy the obtained firmware file to the “update” folder.

NOTE

- If the firmware has been updated in the past, delete any old firmware files from the “update” folder. If there are multiple product files inside the “update” folder, it is indeterminate whether the latest file or an old file is selected.

- 1 Hold down the POWER button on the product for at least one second.**

The product power turns on.

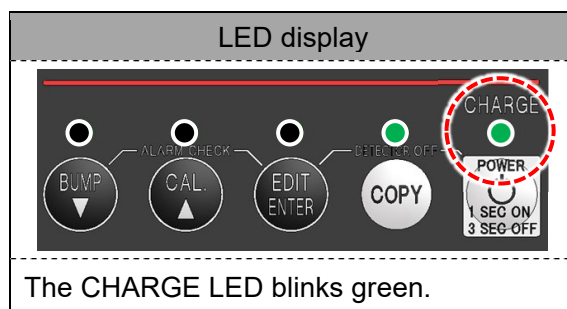

The CHARGE LED blinks green.

- 2 Insert the USB flash drive (sold separately) into the USB port on the front of the product.**

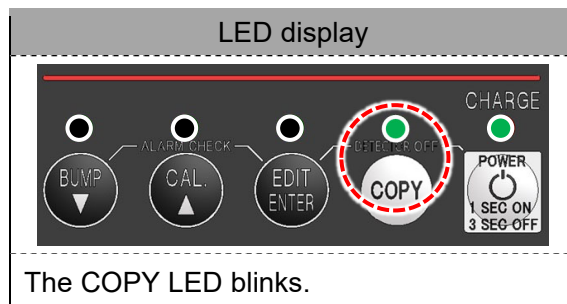

The COPY LED blinks.

- 3 The product enters [UPDATE].**

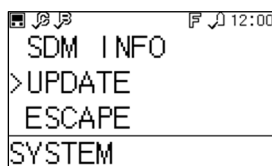
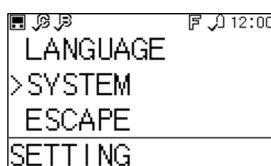

4 Hold down the BUMP, CAL, and COPY buttons for three seconds.

The current firmware version is displayed together with the version of the firmware file in the “update” folder. Hold down the buttons to start the update.

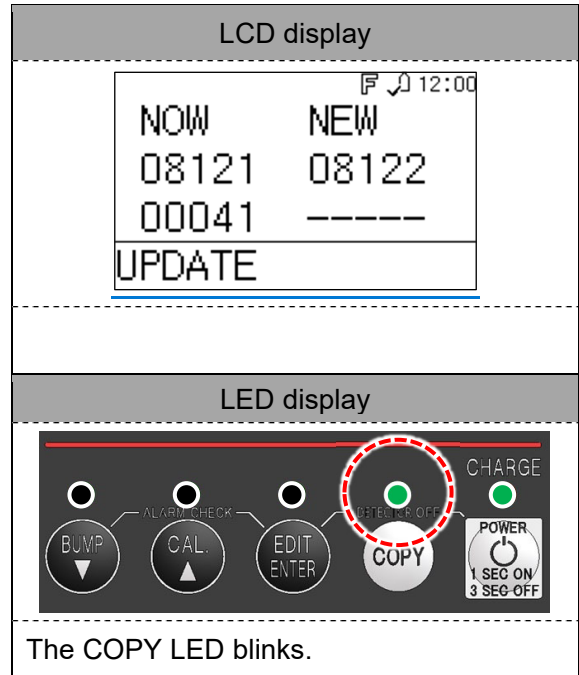

5 Once the update is complete, hold down the POWER button for three seconds.

The product power turns off.

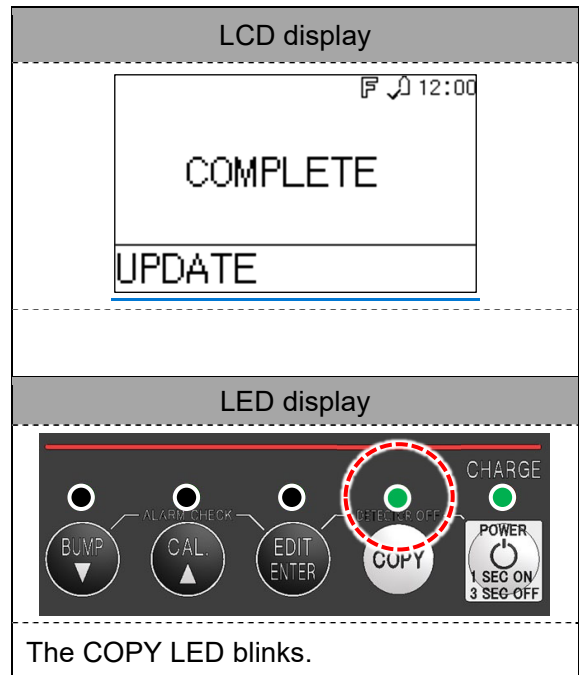

6 <When only the base unit has been updated> Press the POWER button on the product to turn on the power and complete the remaining update process. This takes approximately four seconds, after which the power turns off.

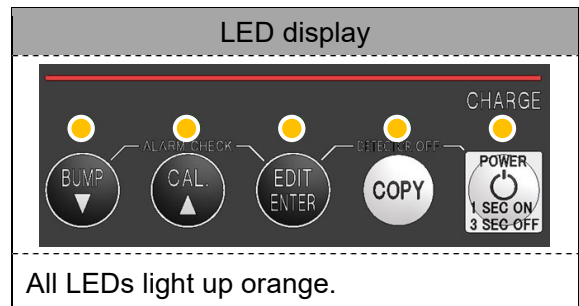

- 7** Hold down the POWER button on the product for at least one second to turn on the power and operate with the updated firmware.

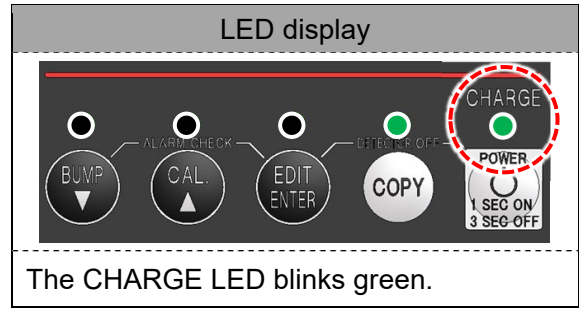

4-6. Operations using the PC Controller Program (sold separately)

4-6-1. Bump test and gas adjustment procedure

Gas adjustment and other operations can be controlled from a PC by connecting the PC to the product. Connecting to a PC allows a calibration certificate to be produced.

The program uses a virtual PC COM port with a USB to UART bridge controller. The USB to UART bridge controller used is the Silicon Laboratories CP2102N.

<Obtaining the driver>

Download and install the CP210x Universal Windows Driver from the Silicon Laboratories website.

<https://www.silabs.com/developer-tools/usb-to-uart-bridge-vcp-drivers?tab=downloads>

NOTE

- The PC Controller Program (sold separately) and a USB cable (Type-A male - Type-B male) (sold separately) are required in order to control the product from a PC. For information on how to install the PC Controller Program (sold separately), refer to '4-2-8. Installing the PC Controller Program (sold separately)'.
- Certain items in the PC Controller Program (sold separately) are password-protected. The password can be changed using [Config] at the top right of the main screen.
Main screen → Right-click on the gas detector icon → [Edit]: 1939 (default setting)
Main screen → [Config] at top right: ABCDE (default setting)

Product LED check locations

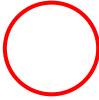
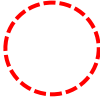
	
Lit steadily	Blinking

- 1 Hold down the POWER button on the product for at least one second to turn on the power.

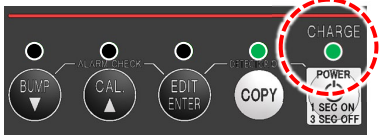
PC screen	LCD display
—	—
—	—
	LED display
—	
—	The CHARGE LED blinks green.

- 2** Start up the PC, then connect the product to the PC using the USB cable (sold separately).
 * USB cable (sold separately): Use a Type-A male - Type-B male USB cable.

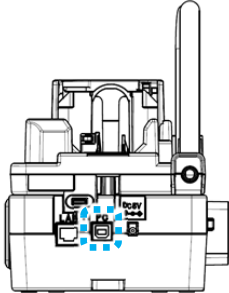
PC screen	LCD display
—	— —
—	<p data-bbox="1042 436 1444 481">Cable connector</p>  <p data-bbox="1042 795 1444 875">Connect to the PC using the USB cable (sold separately).</p>

- 3** Double-click the icon on the PC to launch the PC Controller Program.

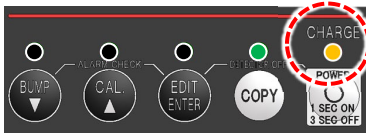
PC screen	LCD display
	— —
The software launches and docking with the product starts.	<p data-bbox="1042 1176 1444 1220">LED display</p>  <p data-bbox="1042 1480 1444 1561">The CHARGE LED blinks orange.</p>

4 Mount the gas detector (sold separately) with its power turned off on the product.

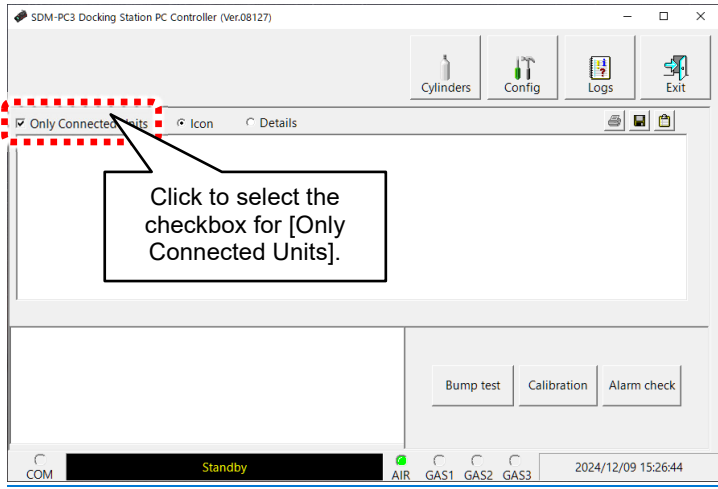
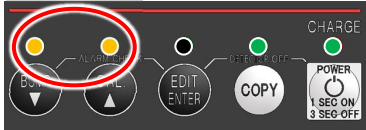
PC screen	LCD display
	<p data-bbox="1161 248 1321 282">LCD display</p> <p data-bbox="1161 611 1321 645">LED display</p> 
<p data-bbox="236 893 986 927">Check the checkbox for [Only Connected Units] on the screen.</p>	<p data-bbox="1054 875 1377 938">The BUMP and CAL LEDs both light up orange.</p>

5 The power for the gas detector (sold separately) turns on, then communication with the product starts.

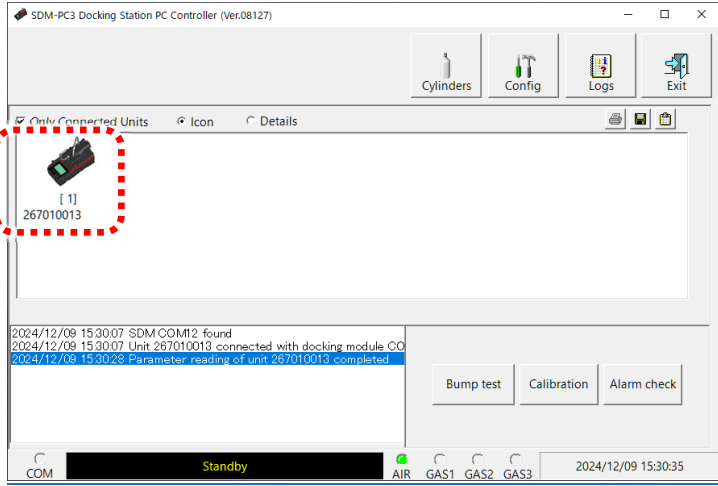
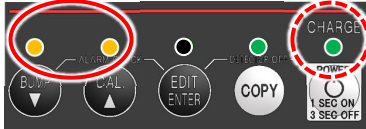
PC screen	LCD display
	<p data-bbox="1161 1090 1321 1124">LCD display</p> <p data-bbox="1161 1435 1321 1469">LED display</p> 
<p data-bbox="236 1747 919 1780">The icon is displayed for the model connected to the PC.</p>	<p data-bbox="1054 1697 1377 1823">The CHARGE LED blinks green. The BUMP and CAL LEDs both light up orange.</p>

- 6 Once communication is established, the gas names set on the gas detector (sold separately) are displayed on the LCD.

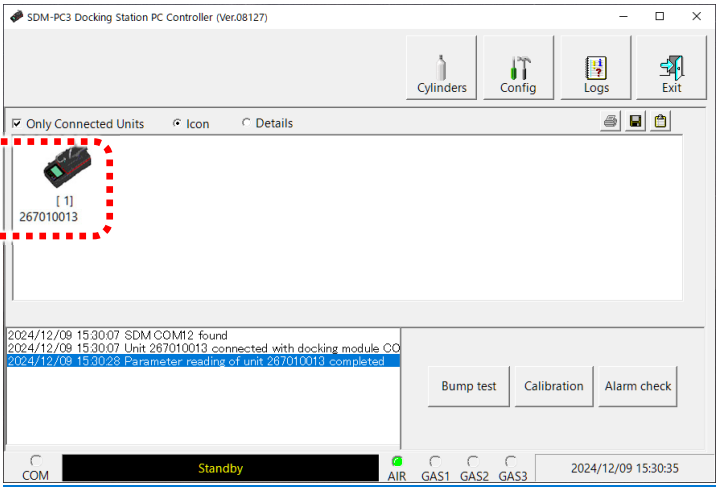
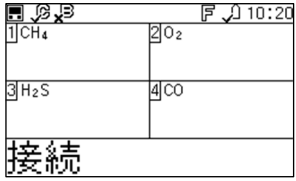
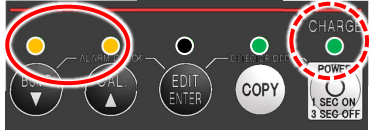
PC screen	LCD display	
		
<p>The icon is displayed for the model connected to the PC.</p>	<p>Once communication is established, [TRANSMIT] is displayed.</p> <th data-bbox="1042 651 1436 723">LED display</th>	LED display
	 <p>The CHARGE LED blinks green. The BUMP and CAL LEDs both blink orange.</p>	

- 7 To register information on the gas cylinders to be used, click [Cylinders] on the PC screen.

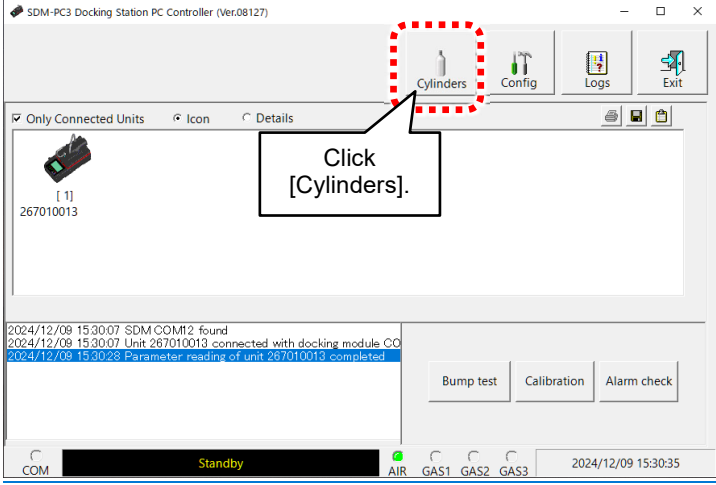
PC screen	LCD display	
	<p>—</p>	
	<th data-bbox="1042 1429 1436 1489">LED display</th>	LED display
	<p>—</p>	

- 8 The cylinder screen is displayed. Enter information on the cylinders to be used and the connection status of the cylinders and inlets.

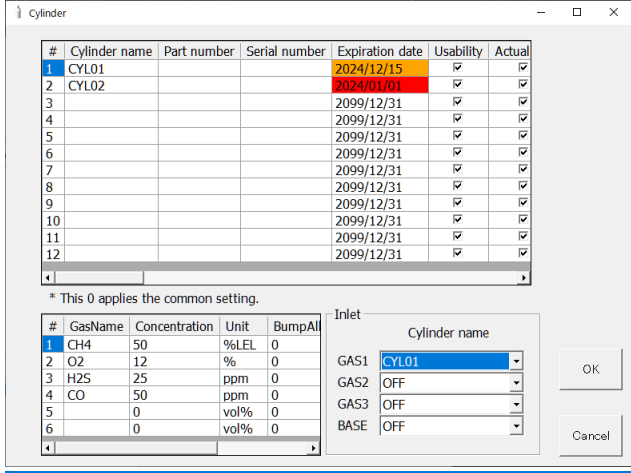

PC screen		LCD display
 <p>The screenshot shows a 'Cylinder' window with two tables. The top table lists cylinders with columns for #, Cylinder name, Part number, Serial number, Expiration date, Usability, and Actual. The bottom table lists gas settings with columns for #, GasName, Concentration, Unit, and BumpAll. To the right, there are dropdown menus for 'Inlet' and 'Cylinder name' with 'OK' and 'Cancel' buttons.</p>		—
		—
		LED display
		—
		—

- [Expiration]: Red: The expiration date has passed.
- [Expiration]: Orange: Less than 10 days remain until the expiration date.
- [Expiration]: Orange: 10 days or more remain until the expiration date.

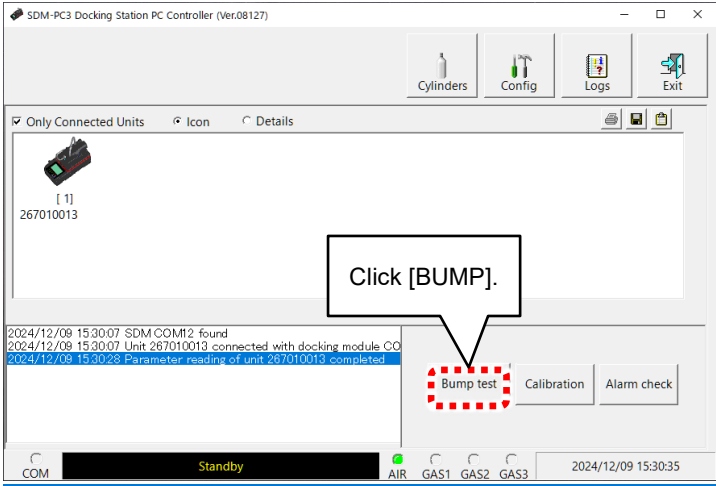
- 9 To perform a bump test, click [BUMP] on the PC screen.

PC screen	LCD display
	—
	—
	LED display
	—
	—

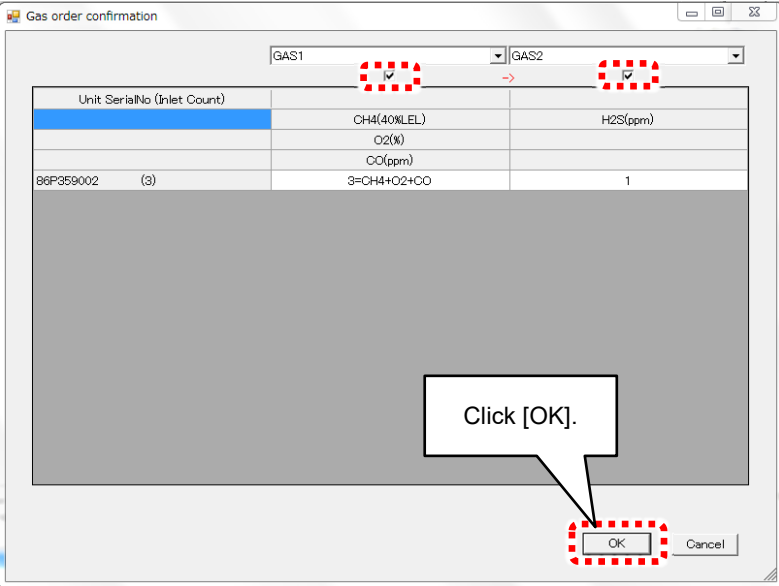
- 10 The gas order confirmation screen appears. If other gases are also to be used, select the checkboxes under [GAS2] and [GAS3] as necessary and select the corresponding gases.

PC screen	LCD display
	—
	—
	LED display
	
<p>Clicking [OK] on the PC screen displays a confirmation window. Click [OK] here too to start the bump test.</p>	<p>The BUMP LED blinks orange.</p>

- 11** To perform gas adjustment, click [Calibration] on the PC screen.

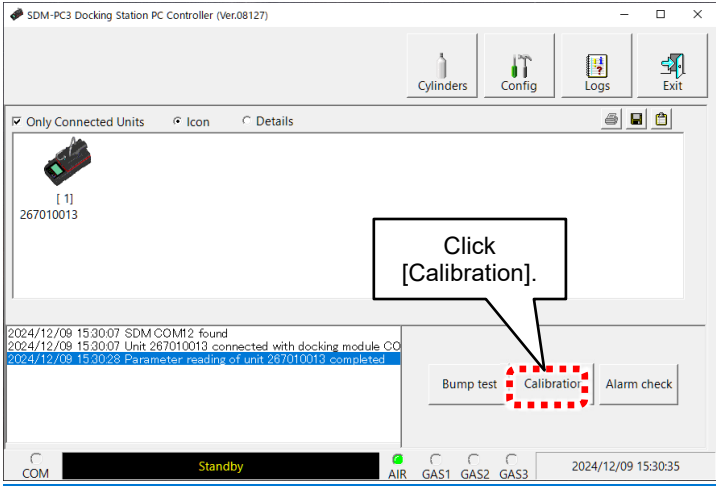
PC screen	LCD display
	—
	—
	LED display
	—
	—

- 12** The gas order confirmation screen appears. If other gases are also to be used, select the checkboxes under [GAS2] and [GAS3] as necessary and select the corresponding gases.

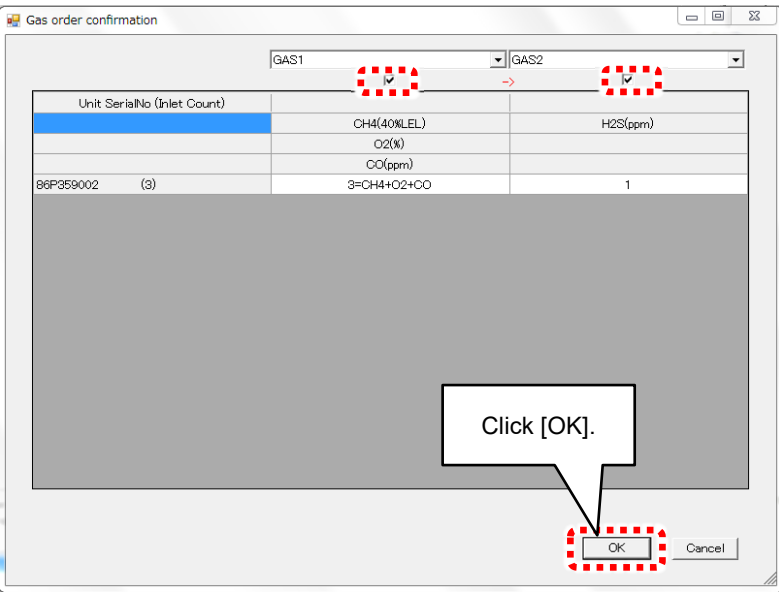
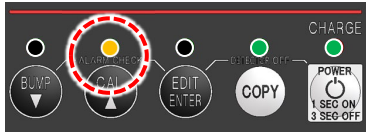
PC screen	LCD display
	—
	—
	LED display
	
<p>Clicking [OK] on the PC screen displays a confirmation window. Click [OK] here too to start gas adjustment.</p>	<p>The CAL LED blinks orange.</p>

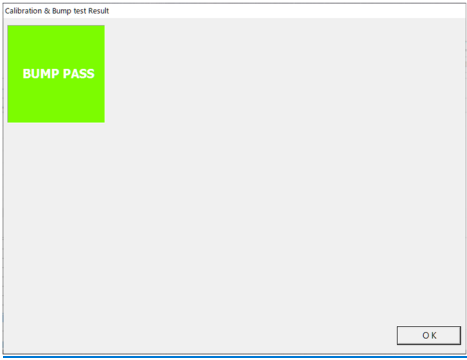
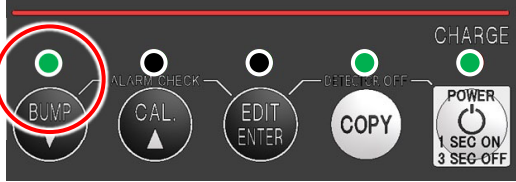

13 The results are displayed. (Bump test)

PC screen	LCD display
	<p style="text-align: center;">—</p> <p style="text-align: center;">—</p> <p style="text-align: center;">LED display</p> 
<p>[BUMP PASS] is displayed if all bump tests were successful.</p>	<p>The BUMP LED lights up green if all bump tests were successful. * The LED lights up red if even one bump test failed.</p>

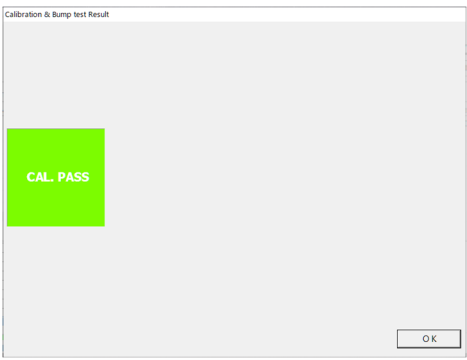
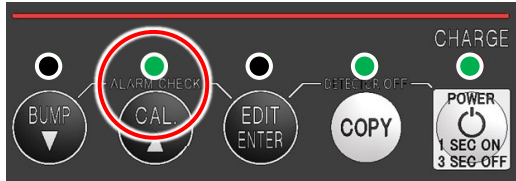
14 The results are displayed. (Gas adjustment)

PC screen	LCD display
	<p style="text-align: center;">—</p> <p style="text-align: center;">—</p> <p style="text-align: center;">LED display</p> 
<p>[CAL. PASS] is displayed if all gas adjustments were successful.</p>	<p>The CAL LED lights up green if all gas adjustments were successful. * The LED lights up red if even one gas adjustment failed.</p>

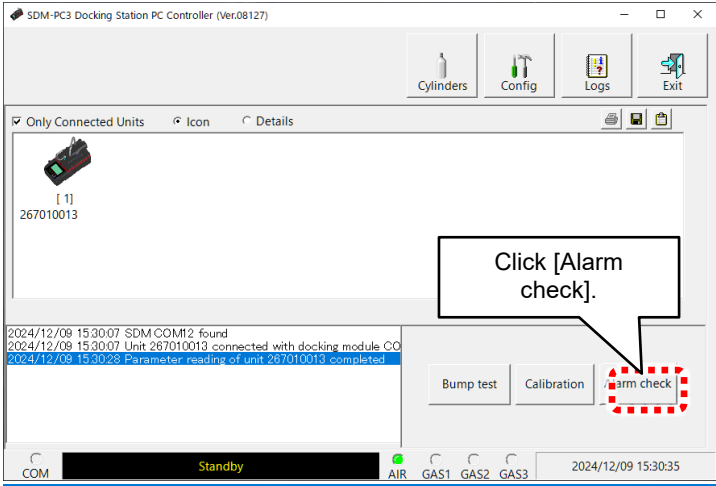
- 15** To perform an alarm check, click [Alarm check] to display a confirmation window. Click [OK] here.

PC screen	LCD display
	<p data-bbox="1042 302 1444 481">—</p> <p data-bbox="1042 481 1444 537">—</p> <p data-bbox="1042 537 1444 593">LED display</p> 
<p data-bbox="225 808 1042 891">The alarm check starts.</p>	<p data-bbox="1042 808 1444 891">The EDIT/ENTER LED blinks orange.</p>

- 16** Once the alarm check ends, the result screen is displayed, and the product LED changes from blinking orange to green.

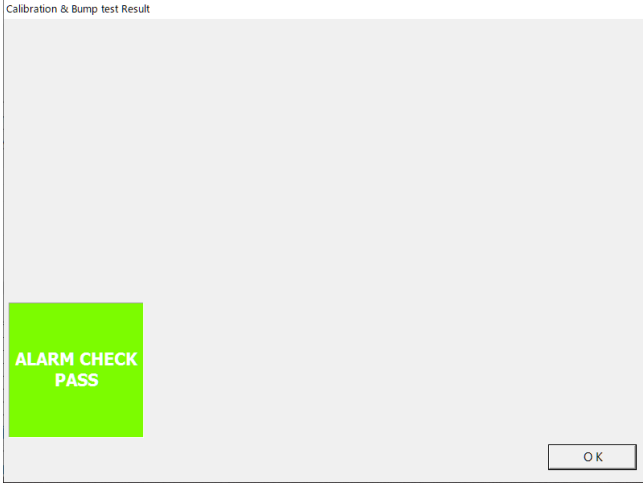
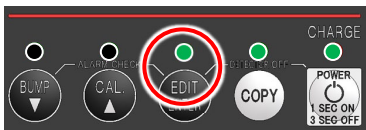
PC screen	LCD display
	<p data-bbox="1042 1095 1444 1232">—</p> <p data-bbox="1042 1232 1444 1332">The alarm LED arrays flash in red.</p> <p data-bbox="1042 1332 1444 1388">LED display</p> 
<p data-bbox="225 1601 1042 1774">[ALARM CHECK PASS] is displayed if the alarm check was successful.</p>	<p data-bbox="1042 1601 1444 1774">The EDIT/ENTER LED lights up green if the alarm check was successful. * The LED lights up red if the alarm check failed.</p>

4-6-2. Creating a calibration certificate

Procedure

PC screen display

- 1 Turn on the product, then connect to the PC.
- 2 Once the PC is connected, click [Logs] on the screen.
- 3 On the PC screen, click the instrument number for the gas detector (sold separately) for which a report is to be created.

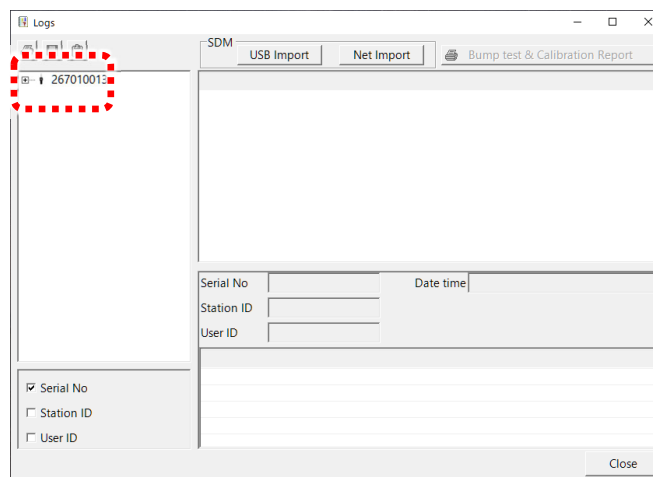
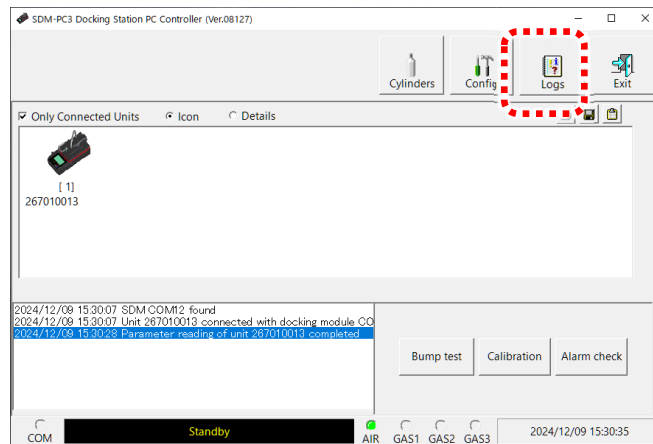

- 4 Click [Calibration] on the PC screen.

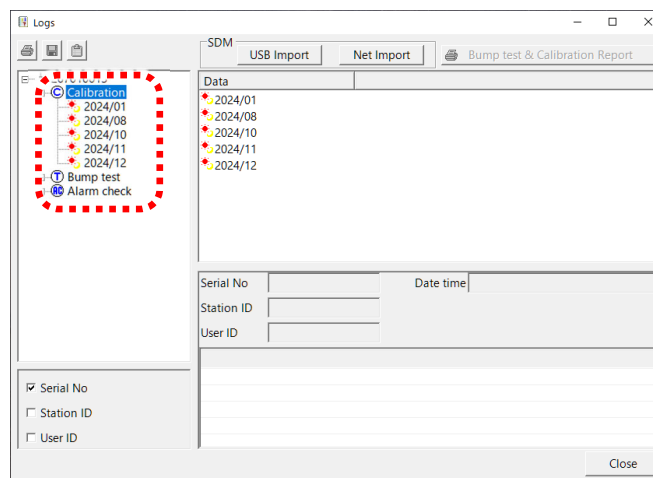

- Click the date.
Displays the details of operations performed on that date.

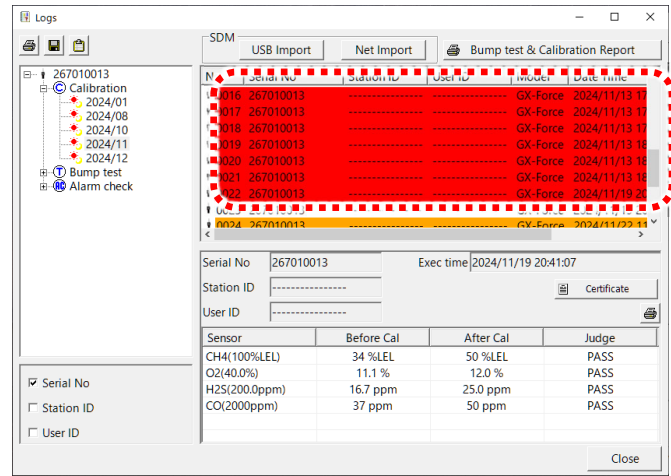

- Select the operations to be included in the certificate, then click [Certificate].

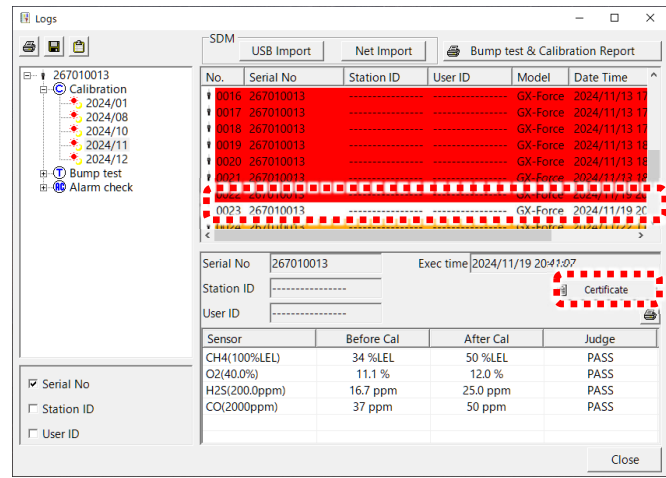

- Check the details, then select the language (English, Portuguese, or Japanese). Click the printer icon to print using the printer set as [Default] in Windows (default setting).

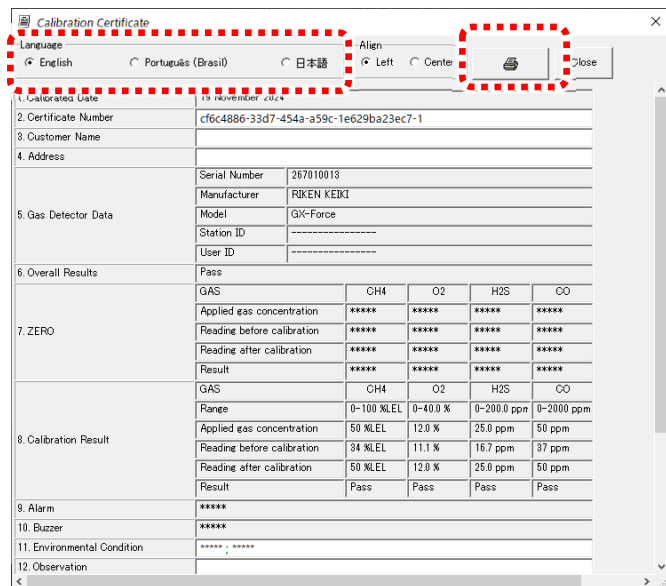

4-7. Turning off the power

NOTE

- The power can be turned off only when the product is not communicating with the gas detector (sold separately).
 - The power for the gas detector (sold separately) can be turned off as follows:
 - <When operating the buttons on the product (independently)>
With the main screen or test result screen displayed, hold down the POWER button and EDIT/ENTER button on the product together for three seconds to turn off the power for the gas detector (sold separately).
The power for the gas detector (sold separately) also turns off automatically if no buttons are operated for more than 10 minutes with the main screen or test result screen displayed.
 - <When using the PC Controller Program (sold separately)>
Right-click the gas detector (sold separately) icon in the PC Controller Program (sold separately), then select [Power off] to turn off the power for the gas detector (sold separately).
The power for the gas detector (sold separately) also turns off automatically if no operation is performed on the main screen for one hour.
-

Hold down the POWER button on the product for three seconds to turn off the power for the product.

5

Maintenance

The product is a precision device.

Maintain the product at regular intervals to ensure product performance and improve gas leak detection reliability.

5-1. Maintenance intervals and maintenance items

Maintain the following items at regular intervals before use:

- Daily maintenance (Pre-work checks): Perform maintenance before commencing work.
- Regular maintenance: Request maintenance at least once a year to ensure product performance.

Maintenance item	Maintenance details	Daily maintenance	Regular maintenance
Filter check	Check to confirm that the cylindrical filter is not dirty or clogged.	○	○
Gas	Check to confirm that the calibration gas cans are correctly connected and that they have residual pressure.	○	○

Maintenance service

RIKEN KEIKI provides services related to regular maintenance, adjustment, and servicing. Our certified service engineers have expert knowledge of the dedicated tools used for these services, along with expertise in products. We recommend taking advantage of our maintenance service to ensure safe use of the product.

The major maintenance service items are as follows. For more information, contact RIKEN KEIKI.

<Main service details>

Item	Description
Filter check	Checks the cylindrical filter for contamination and clogging. Replacement if dirty or clogged
Product cleaning and repair (Visual inspection)	Checks the product exterior for dirt and cleaning/repairing of visible areas. Replace parts if cracked or damaged.
Product operation check	Checks operation of individual functions using buttons and checking parameters.
Consumable part replacement	Replacing tubes, cylindrical filter, and other consumable parts

5-2. Cleaning instructions

Clean the product if it becomes excessively dirty. Be sure to turn off the power before cleaning, and wipe clean using a cloth. Do not clean using water or organic solvents for cleaning, as these may cause the product to malfunction.



CAUTION

- Do not use water or organic solvents such as alcohol or benzene when wiping the product. These may discolor or damage the surface of the product.

5-3. Parts replacement

5-3-1. Periodic replacement parts

The consumable parts of the product are listed below. Consumable parts should be replaced using the recommended replacement intervals as a guide.

<Recommended replacement parts list>

	Name	Part No.	Recommended check interval	Recommended replacement interval	Remarks
①	Cylindrical filter	4383 0690 90	Before and after use	6 months to 1 year	
②	Tube (approx. 40 mm)	4395 4424 80	6 months	3 to 8 years	
③	GAS IN tube ($\varnothing 7 \times \varnothing 4$, approx. 240 mm)	1680 1467 00	6 months	3 to 8 years	
④	GAS OUT tube ($\varnothing 12.7 \times \varnothing 7.94$, approx. 260 mm)	1680 1355 20	6 months	3 to 8 years	

NOTE

The above replacement intervals are guidelines only. Replacement intervals may vary depending on actual operating conditions. These intervals do not constitute warranty periods. Replacement intervals may vary depending on the results of regular maintenance.

5-3-2. Replacing the cylindrical filter (dust filter)

The cylindrical filter may become dirty and clogged with continued use.

Replace the filter if it appears especially dirty.

Also replace the filter if water has been sucked in or the flow rate drops.

When replacing the filter, replace both the filter and the tube if you notice any abnormalities in the tube, including deformation, discoloration, or cracking.

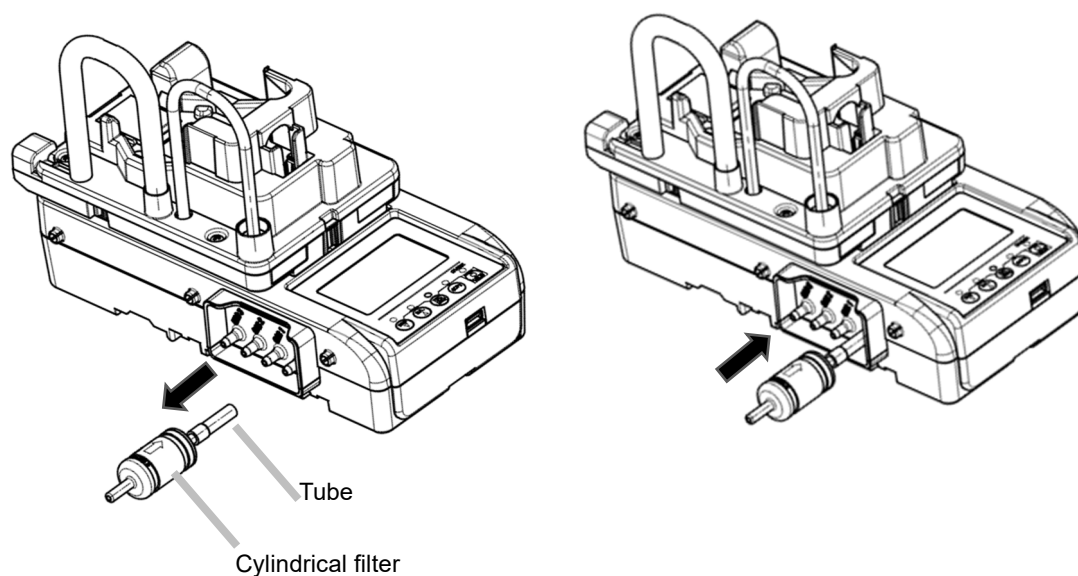

Remove the cylindrical filter attached to the AIR inlet on the side of the product, then attach a new filter aligning the direction of the engraved arrow.

5-4. Portable gas detector maintenance

For information on portable gas detector operating instructions and handling precautions, refer to the GX-Force Portable Gas Detector Operating Manual (PT0E-210).

Storage and Disposal

6-1. Procedures for storage or when not in use for extended periods

The product must be stored in the following environment:

- At normal temperature and humidity in a location not exposed to direct sunlight
- In a location free of gases, solvents, and vapors

Store the product in its shipping carton if this has been retained.

If the shipping carton is not available, store away from dust and dirt.

6-2. Product disposal

Dispose of the product as industrial waste (incombustible) in accordance with local regulations.

6-3. Disposing of gas cylinders (sold separately)

Dispose of the gas cylinders (sold separately) as industrial waste (incombustible) in accordance with local regulations.

Troubleshooting

This troubleshooting chapter does not cover the causes of all possible product malfunctions. It provides brief explanations to assist in determining the causes of common problems. If you encounter symptoms not addressed here or if problems persist even after taking corrective action, contact RIKEN KEIKI.

Symptom <Display>	Cause	Action
The power cannot be turned on.	The AC power supply is not correctly connected or the AC power supply voltage is below the stipulated rating.	Check the AC power supply socket connection. Check to confirm that the AC adapter is correctly connected to the product. If no problem is identified, contact RIKEN KEIKI.
	The POWER button was held down for too short or too long a time.	To turn on the power, hold down the POWER button until [SDM-Force] appears on the LCD, then release the button.
Abnormal operation	Effects of sudden static electricity noise, etc.	Turn off the power, then turn it back on again.
Fresh air adjustment is not possible.	Fresh air is not being supplied around the product.	Provide fresh air.
	The sensor sensitivity has degraded.	Contact RIKEN KEIKI to request sensor replacement.
Low flow rate alarm indication	Water or oil has been aspirated into the interior.	Check the gas sampling tube to confirm it is not damaged and that no oil or water has been sucked in.
	The piping is kinked.	Check to confirm that the piping is not kinked.
	The filter is clogged.	Check the filter mounting condition and whether it is clogged or twisted.
	The pump is deteriorated.	Contact RIKEN KEIKI to request pump replacement.
	Stored for extended periods out of use (six months or more).	If a low flow rate error is displayed, turn off the power, then turn it back on again (restart). If the problem persists even after repeating this process several times, contact RIKEN KEIKI to request pump replacement.
	Outside operating temperature range	If used outside the operating temperature range, the pump may not operate correctly, causing a low flow rate alarm. Check the usage environment and check the operation again.

Symptom <Display>	Cause	Action
Gas adjustment is not possible. Adjustment error	The calibration gas is not connected correctly to the gas inlet.	Check to confirm that the filter is fitted correctly.
	The gas outlet is blocked.	Check to confirm that the gas outlet piping is not blocked. If no problem is identified, contact RIKEN KEIKI.
Alarm check failed	An abnormality occurred in the detector alarm display.	Perform the alarm check in a quiet location. Also remove the gas detector from the product, then check the alarm operation of the detector on its own. If no problem is identified, contact RIKEN KEIKI.
	Effects of external light	It may not be possible to correctly detect illumination of the gas detector alarm lamp due to the effects of external light such as strong sunlight. Check the ambient conditions.
	Ambient noise	It may not be possible to correctly detect the gas detector buzzer due to the effects of ambient noise. Check the ambient conditions.
Unable to charge gas detector	The temperature is outside the permissible charging temperature range.	Allow the product to fully adjust to temperatures within the operating temperature range before plugging the USB cable back in again to recharge the battery. If no problem is identified with the operating temperature, contact RIKEN KEIKI.

<System abnormality>

Fault No.	Cause	Action
E000	<ul style="list-style-type: none"> Product (base unit) internal ROM abnormality Effects of abnormal noise 	Contact RIKEN KEIKI.
E010	<ul style="list-style-type: none"> Product (base unit) internal RAM abnormality Effects of abnormal noise 	Contact RIKEN KEIKI.
E021	<ul style="list-style-type: none"> Product (base unit) internal FLASH abnormality Effects of abnormal noise 	Contact RIKEN KEIKI.
E041	<ul style="list-style-type: none"> Product internal communication abnormality Effects of abnormal noise 	Restart the product. If the problem persists, contact RIKEN KEIKI.
E042	<ul style="list-style-type: none"> The base unit is incompatible with the type specific unit after updating the firmware. 	Update the base unit firmware.
E043	<ul style="list-style-type: none"> Product internal solenoid valve failure 	Contact RIKEN KEIKI.
E044		
E050	<ul style="list-style-type: none"> Product internal clock abnormality Effects of abnormal noise 	Set the date and time. If this symptom occurs frequently, the internal clock battery must be replaced. Contact RIKEN KEIKI.
E062	<ul style="list-style-type: none"> A gas detector (sold separately) incompatible with the product is connected. 	Connect a gas detector (sold separately) compatible with the product.
E064	<ul style="list-style-type: none"> Gas detector (sold separately) charging abnormality 	Restart the product. If this occurs frequently, contact RIKEN KEIKI.
E070	<ul style="list-style-type: none"> Writing to USB flash drive (sold separately) failed. 	Reinsert the USB flash drive (sold separately), then try again.
	<ul style="list-style-type: none"> Insufficient USB flash drive (sold separately) memory capacity 	Increase the free space on the USB flash drive (sold separately) if it is less than 1 MB.
E082	<ul style="list-style-type: none"> Product internal LAN function abnormality 	Contact RIKEN KEIKI.
E085	<ul style="list-style-type: none"> Product internal temperature and humidity sensor abnormality 	Contact RIKEN KEIKI.
E100	<ul style="list-style-type: none"> Product (type specific unit) internal ROM abnormality Effects of abnormal noise 	Contact RIKEN KEIKI.
E110	<ul style="list-style-type: none"> Product (type specific unit) internal RAM abnormality Effects of abnormal noise 	Contact RIKEN KEIKI.
E120	<ul style="list-style-type: none"> Product (type specific unit) internal FLASH abnormality Effects of abnormal noise 	Contact RIKEN KEIKI.

Product Specifications

8-1. Specifications list

Model		SDM-Force (C1)	SDM-Force (C2)	SDM-Force (C3)
Number of inlets	AIR	One	One	One
	GAS	One (GAS1)	Two (GAS1,GAS2)	Three (GAS1,GAS2,GAS3)
Compatible gas detector		GX-Force		
Display		LCD digital (full dot)		
Display languages		Japanese, English, Korean, Chinese (Simplified, Traditional), Vietnamese, German, French, Spanish, Portuguese, Italian, Polish, Czech, Slovak, Romanian, Turkish, Russian		
Status display		LED (Green, orange, red /Steady light, blinking)		
Interface		USB (for USB flash device, PC communication), LAN		
PC communication		Wired connection (USB cable, LAN cable)		
Maximum data storage capacity		Up to 500 items (bump test, gas adjustment, alarm check)		
Input power supply		Main unit input: 5.2 V DC Accessory AC adapter input: 100 to 240 V AC, 50/60 Hz		
Memory capacity		1 MB		
Operating temperature range		0 to +40 °C (no sudden fluctuations)		
Operating humidity range		0 to 95 %RH (no condensation)		
External dimensions		Approx. 130 mm (W) × 138 mm (H) × 272 mm (D) (excluding projections)		
Weight		Approx. 1.0 kg		

8-2. Accessory list

Accessories

Part name	Part No.
Cylindrical filter	4383 0690 90
Tube (approx. 40 mm)	4395 4424 80
AC adapter	2594 1759 80
Connecting fixture (set of 2)	4395 9166 40
USB cable (Type-C male - Type-C male)	2440 3104 70

Optional accessories

Part name	Part No.
Connecting fixture (set of 2)	4395 9166 40
Wall mounting fixture (set of 2)	4395 9165 70
Exhaust tube (2 m)	4395 4442 10
Exhaust tube (5 m)	4395 4444 60
AV jack cap (for LAN connector)	0800 0941 50
AU plug	2594 1434 20
EU plug	2594 1435 00
UK plug	2594 1436 70
USB flash drive	2594 1084 30
USB cable	2440 3321 10
LAN cable (shielded)	2440 3330 20
PC Controller Program (SW-SDM-PC3(EX))	9812 0110 50

Revision history

Issue	Revision	Issue date
0	First issue	February 5, 2025



EU-Declaration of Conformity

Document No. 320CE24124



We, RIKEN KEIKI Co., Ltd. 2-7-6, Azusawa, Itabashi-ku, Tokyo, 174-8744, Japan declare under our sole responsibility that the following product conforms to all the relevant provisions.

Product Name Bump and Gas Calibration station
Model SDM-Force, SDM-GW3, SDM-04

Council Directives	Applicable Standards
EMC Directive (2014/30/EU)	EN 61000-6-4:2007+A1:2011 EN 61000-6-2:2005/AC:2005
RE Directive (2014/53/EU)	EN 301 489-1 V2.2.3 EN 301 489-17 V3.2.4 EN 300 328 V2.2.2 EN 62479:2010
BATTERY Regulation ((EU)2023/1542)	-
RoHS Directive (2011/65/EU[1])	EN IEC 63000:2018

^[1]Including substances added by Commission Delegated Directive (EU) 2015/863

Place: Tokyo, Japan

Date: Jan. 27, 2025

Takakura Toshiyuki
General manager
Quality Control Center